

ARQIS208i

CABINET LOUDSPEAKERS

Architectural Loudspeaker Cabinet

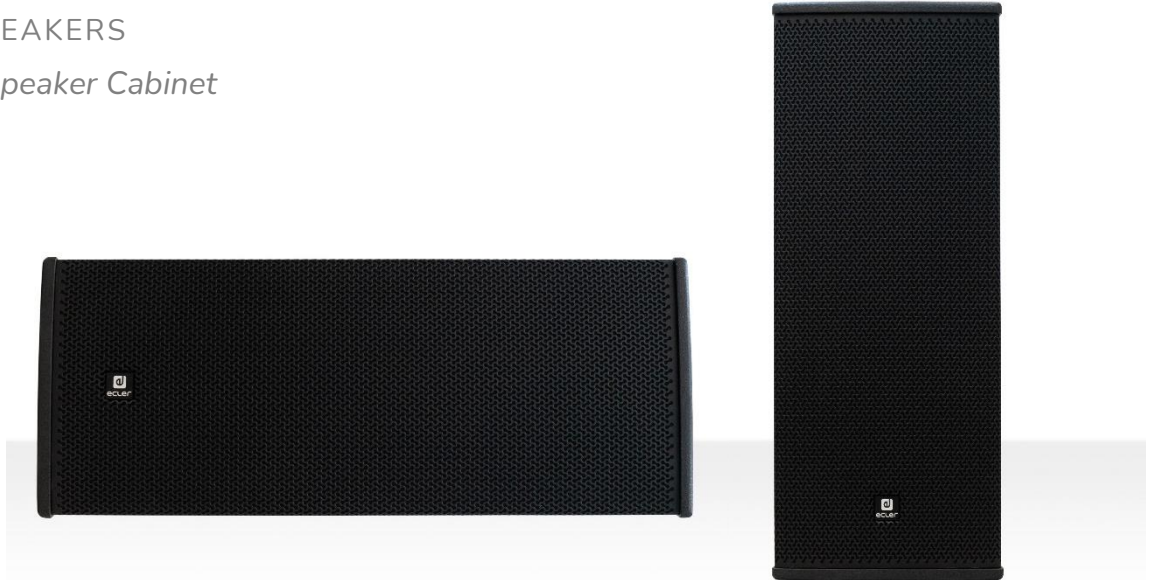

PRODUCT OVERVIEW

ARQIS208i is a 2-way wooden loudspeaker cabinet with a compact format, stylish aesthetics, excellent sound quality and long-term reliability, featuring 300 WRMS @ 8Ω, 2 x 8" woofer and 1" HF Compression Driver. Its "U" shape wall bracket (included) allows for tilt adjustment. It has been specifically designed to fulfil permanent installation requirements where a perfect balance between sound performance and architectural/interior's design matching is a must.

KEY FEATURES

- Full range, 2-way architectural loudspeaker
- 300 WRMS @ 8 Ω
- 2 x 8" low frequency woofer
- 1" high frequency compression driver (rotatable)
- Double INPUT/STACK connector, Euroblock + Speakon® type, with security attachment screws to avoid accidental disconnection
- "U" Shape wall bracket included, allowing for tilt adjustment
- 4x M6 & 12 x M8 cabinet flying points.
- Metal safety sling included, to avoid drops in case of accidental detachment from the wall surface
- Available in black (RAL 9005) and white (RAL 9003) colour
- [Ecler ARQISi EQ Settings](#) available
- EASE files available



APPLICATIONS

- Commercial
- Corporate
- Hotels and restaurants
- Education
- Sports and wellness
- Leisure

TECHNICAL SPECIFICATIONS

ARQIS208i	
System	
Effective frequency range ¹	73Hz-20kHz
Coverage angle ²	130° x 30° (HxV)
Power handling	300W RMS / 1200W peak
Sensitivity ³	94dB (1W/1m)
Maximum SPL ⁴	119dB RMS / 125dB peak
Recommended amplifier	600W
Transducers	
Ways	2-way, full range
Low frequency driver	2x 8" woofer
High frequency driver	1" Compression driver (rotatable)
Nominal impedance	8Ω
Filters	
Crossover filter	2,6 kHz
Recommended High-Pass protection filter	70 Hz with minimum 12 dB / octave filter
Physical	
Connection type	1 x Euroblock & 1x SPEAKON®
Installation options	Surface, wall, desktop
Environmental	IP31
Enclosure material	MDF
Grille material	Steel
Grille fixing system	Screw fixation
Flying points	4x M6 & 12 x M8
Operating temperature	Min: -10°C ; 14°F Max: 40°C ; 104°F
Operating humidity	<90% HR
Storage temperature	Min: -10°C ; 14°F Max: 40°C ; 104°F
Storage humidity	<90% HR
Included accessories	U Bracket / 5mm Allen key / 6mm Allen key
Finished color	Black (RAL9005) or White (RAL 9003)
Dimensions (WxHxD)	610 x 244 x 280 mm / 24.01 x 9.61 x 11.02 in
Weight	14,8 kg / 32,62 lb
Pieces per box	1 unit
Shipping dimensions (WxHxD)	670 x 325 x 370 mm / 26.38 x 12.80x 14.57 in
Shipping weight	16.4 kg / 36.15 lb

¹10dB below the sound pressure level at specified sensitivity

²6dB below the sound pressure level than that at the direction of maximum level, Max. angle between 1 kHz and 4 kHz.

³Measured on-axis, far field and referenced to 1 meter by inverse square law. Average from 100 Hz to 10 kHz.

⁴Calculated from sensitivity and power handling specifications, exclusive of power compression

FREQUENCY RESPONSE ON-AXIS

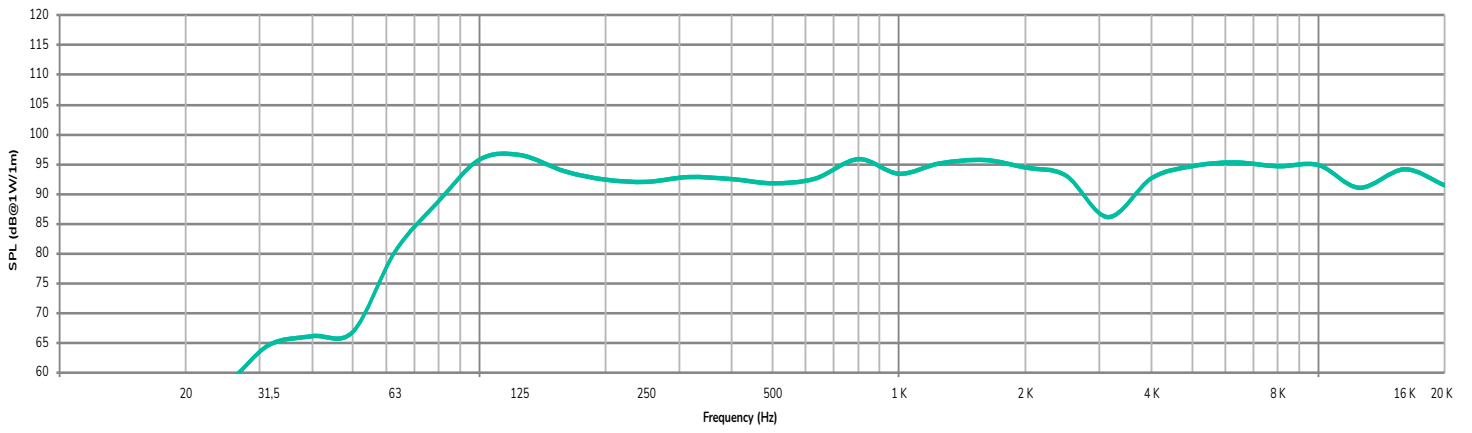

MECHANICAL DIAGRAMS

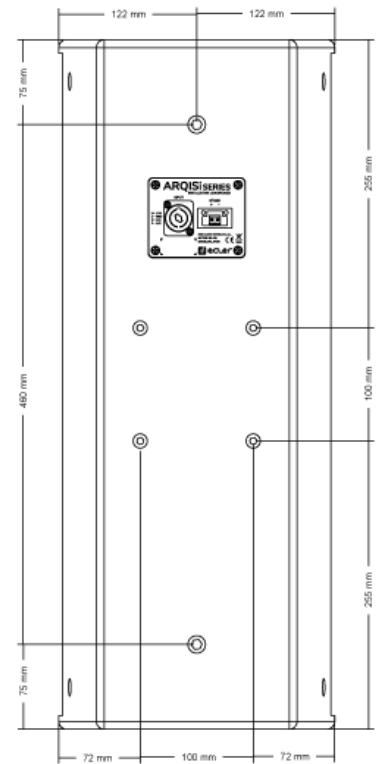
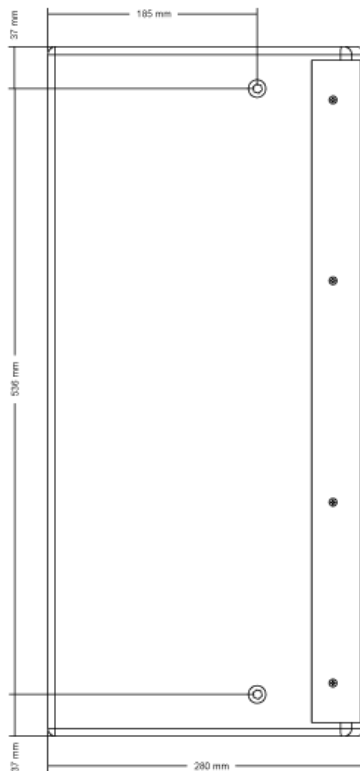
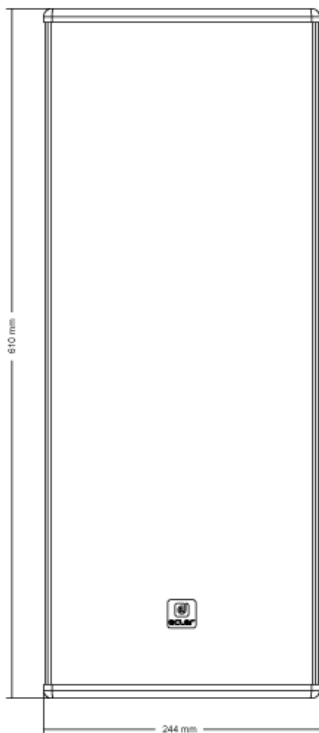
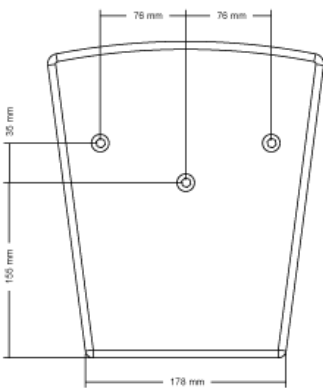

POLAR DIAGRAMS

HORIZONTAL

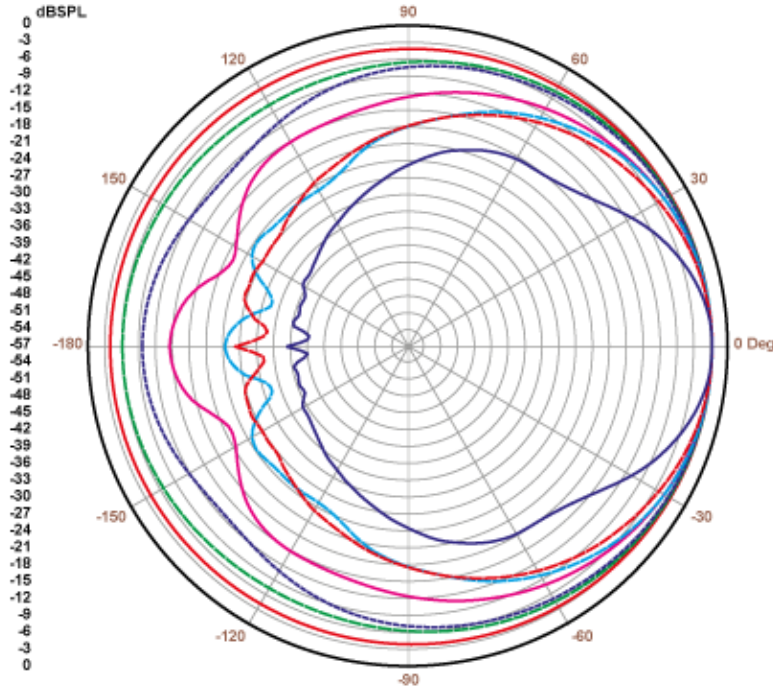

VERTICAL

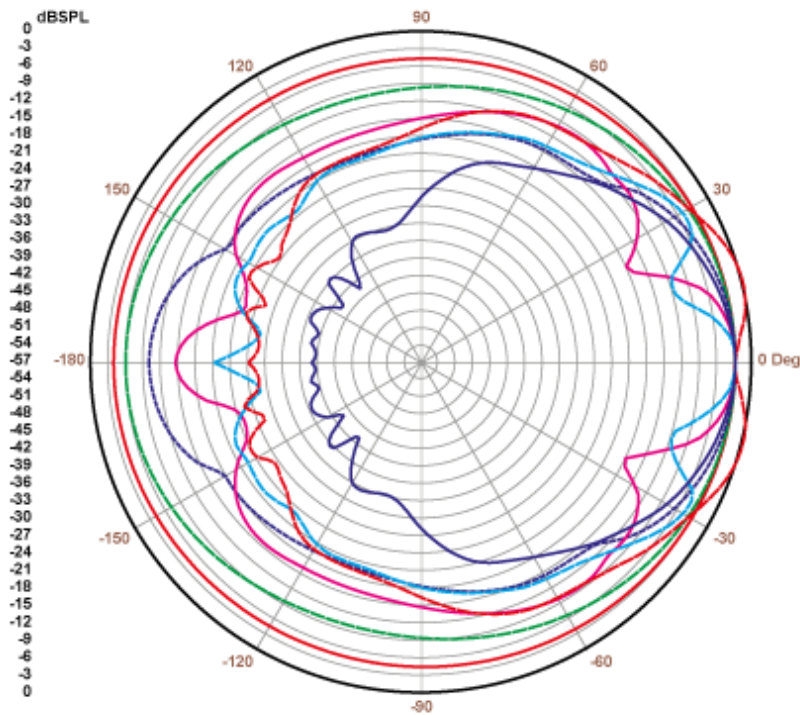

A&E SPECIFICATIONS

The loudspeaker shall be a 2-way wooden loudspeaker cabinet, incorporating high-efficiency 2x8" mid/low woofer and 1" rotatable compression driver. It shall have a power handling of 300 W RMS with a peak power handling of 1200 W and the effective frequency range (± 10 dB) shall be from 73 Hz to 20 kHz.

Crossover filter shall be at 2,6 kHz. The sensitivity shall be 94 dB when measuring with an input signal of 1 Watt at a distance of 1 meter, while the maximum continuous sound pressure level shall be 111 dB.

The coverage angle shall be $130^\circ \times 30^\circ$ (HxV).

The loudspeaker shall have a nominal impedance of 8 Ω . It shall have an enclosure constructed out of medium density wood with a textured and scratch resistant paintwork finish.

The front finishing shall be made with an overlapping front grill with a rotatable logo, giving a slim and elegant impression. It shall include a Speakon and Euroblock connector, with security attachment screws to avoid accidental disconnection.

It shall include a U wall bracket, which enables tilt adjustment. An additional metal safety sling shall be provided, to avoid drops in case of accidental detachment. The full range system's enclosure shall be 610 mm wide, 244 mm high and 280 mm deep and the weight shall not exceed 14,8 Kg.

The loudspeaker shall be the ECLER ARQIS208i.



All product characteristics are subject to variation due to production tolerances. **NEEC AUDIO BARCELONA S.L.** reserves the right to make changes or improvements in the design or manufacturing that may affect these product specifications

For technical queries contact your supplier, distributor or complete the contact form on our website, in [Support / Technical requests](#).

Motors, 166-168 08038 Barcelona - Spain - (+34) 932238403 | information@ecler.com | www.ecler.com