

eCOMPACT4BT

ANALOGUE PREAMPS AND MIXERS

4-channel Bluetooth® mixer



USER MANUAL

CONTENTS

1. IMPORTANT WARNING.....	3
2. IMPORTANT SAFETY INSTRUCTIONS	4
3. IMPORTANT NOTE	5
4. INTRODUCTION	5
<i>4.1. Main features.....</i>	<i>6</i>
5. INSTALLATION.....	7
<i>5.1. Location, set up and ventilation</i>	<i>7</i>
<i>5.2. AC connection and powering on</i>	<i>7</i>
6. FRONT PANEL	8
7. BACK PANEL.....	10
8. CONNECTIONS.....	11
<i>8.1. Audio Input Connections.....</i>	<i>11</i>
<i>8.2. Bluetooth® connection</i>	<i>14</i>
<i>8.3. Audio output connections.....</i>	<i>15</i>
<i>8.4. Other connections.....</i>	<i>18</i>
9. OPERATION AND USE	18
<i>9.1. Start-up.....</i>	<i>18</i>
<i>9.2. Monitoring.....</i>	<i>19</i>
<i>9.3. Channel gain and equalization.....</i>	<i>19</i>
<i>9.4. Channel indicators</i>	<i>20</i>
<i>9.5. Talkover function.....</i>	<i>20</i>
<i>9.6. Outputs</i>	<i>21</i>
10. CONSIDERATIONS	21
<i>10.1. Ground loops.....</i>	<i>21</i>
<i>10.2. Background noise</i>	<i>21</i>
11. BLOCK DIAGRAM	22
12. CONFIGURATION DIAGRAM.....	23
13. TECHNICAL SPECIFICATIONS	24
14. PACKAGE CONTENTS.....	25
15. Ecler Bluetooth® Manager PRODUCT OVERVIEW.....	27
<i>15.1 Versions.....</i>	<i>27</i>
<i>15.2 Compatible Devices.....</i>	<i>27</i>
<i>15.3 Operation</i>	<i>27</i>

1. IMPORTANT WARNING



WARNING: SHOCK HAZARD - DO NOT OPEN
AVIS: RISQUE DE CHOC ÉLECTRIQUE - NE PAS OUVRIR



The lightning flash with arrowhead symbol within an equilateral triangle is intended to alert the user to the presence of uninsulated “dangerous voltage” within the product’s enclosure that may be of sufficient magnitude to constitute a risk of electric shock to persons.



The exclamation point within an equilateral triangle is intended to alert the user to the presence of important operating and maintenance (servicing) instructions in the literature accompanying the appliance.

WARNING (if applicable): terminals marked with the "" symbol may be of sufficient magnitude to constitute a risk of electric shock. The external cables connected to the terminals require installation by qualified personnel or the use of pre-assembled cables.

WARNING: to prevent fire or shock hazard, do not expose this equipment to rain or moisture.

WARNING: apparatus with Class I construction shall be connected to a mains socket outlet with a protective earthing connection.

2. IMPORTANT SAFETY INSTRUCTIONS

1. Read these instructions.
2. Keep these instructions.
3. Heed all warnings.
4. Follow all instructions.
5. Do not use this apparatus near water.
6. Clean only with dry cloth.
7. Do not block any ventilation openings. Install in accordance with the manufacturer's instructions.
8. Do not install near any heat sources such as radiators, stoves or other apparatus that produce heat, including amplifiers.
9. Do not defeat the safety purpose of the polarized or grounding-type plug. A polarized plug has two blades with one wider than the other. A grounding type plug has two blades and a third grounding prong. The wide blade or the third prong are provided for your safety. If the provided plug does not fit into your outlet, consult an electrician for replacement of the obsolete outlet.
10. Protect the power cord from being walked on or pinched particularly at plugs, convenience receptacles, and the point where they exit from the apparatus.
11. Only use attachments/accessories specified by the manufacturer.
12. Unplug this apparatus during lightning storms or when unused for long periods of time.
13. Refer all servicing to qualified service personnel. Servicing is required when the apparatus has been damaged in any way, such as power supply cord or plug is damaged, liquid has been spilled or objects have fallen into the apparatus, the apparatus has been exposed to rain or moisture, does not operate normally, or has been dropped.
14. Mains disconnection: turning off the POWER switch stops all the device functions and indicators from operating, but complete disconnection is achieved by disconnecting the mains power cable from its connector. For this reason, it shall remain readily operable.
15. The unit is connected to a protective earthing plug via the power cord.
16. Part of the product labelling is located at the base of the product.
17. This apparatus should not be exposed to dripping or splashing and no objects filled with liquids, such as vases, should be placed on the apparatus.



WARNING: this product must not be disposed of as unsorted household waste under any circumstances. Go to the nearest electrical and electronic waste recycling facility.

NEEC AUDIO BARCELONA, S.L declines any responsibility for damages caused to people, animals or objects due to failure to comply with the above warnings.

3. IMPORTANT NOTE

Thank you for choosing our **4-channel Bluetooth® eCOMPACT4BT mixer**. It is VERY IMPORTANT to carefully read this manual and to fully understand its contents before any connection in order to maximize your use and get the best performance from this equipment.

To ensure optimal operation of this device, we strongly recommend that its maintenance be carried out by our authorised Technical Services.

The eCOMPACT4BT comes with a 3-year warranty.

4. INTRODUCTION

The eCOMPACT4BT is a desktop and 19" rackmount 4-channel mixer with Bluetooth® for professional installation. Simple to operate, suitable for both experienced and novice users. Features 4 microphone inputs, 6 stereo line inputs, USB charging port, Bluetooth® wireless connection and a mini-jack input for external devices. All microphone inputs have a switchable high-pass filter. 3-band tone control and ALT Send (sub-mix channel) on all channels. Balanced main output (XLR connector), SUB OUT output for sub bass (XLR connector) and alternative ALT output (RCA connector). Stereo/mono switch for main output, allowing various configurations: 2 stereo outputs (MAIN and ALT) or 2 mono outputs (MAIN) and one stereo output (ALT), plus one mono output (SUB). The SUB OUT also features a low-pass filter for connecting a subwoofer or using it as a monitor output (filter disabled). One channel Talkover function for front panel microphone input (48 V phantom power available for all microphone inputs), and front panel mini-jack headphone output.

4.1. Main features

- 4-channel analogue mixer, one channel with adjustable Talkover
- Desktop or 19" rack installation
- 4 microphone inputs, one of which on front panel with a combo connector
- 48 V phantom power for microphone inputs (rear panel selector)
- 6 RCA stereo line inputs, and one stereo mini-jack line input on front panel
- Class 1 Bluetooth® wireless connection (up to 25 m range under ideal conditions)
- Source selector on each channel
- All microphone inputs have a selectable high-pass filter ($f_c = 100$ Hz)
- All channels have a 3-band tone control (treble, midrange and bass)
- Input signal presence and overload indicators on all channels
- 45 mm faders
- ALT OUT (alternative output) send per channel. Sub-mix available
- USB port for charging mobile devices
- Balanced main output (MAIN OUT), XLR connector
- Stereo/mono switch for main output
- Signal indicators (LED) with measured output signal selector (MAIN OUT or ALT OUT)
- Unbalanced alternative or sub-mix output (ALT OUT), RCA connector
- Sub-bass or auxiliary output (SUB OUT), XLR connector. Mono sum of the main output signal
- Low-pass filter available on SUB OUT ($f_c = 150$ Hz)
- Front panel headphone output, mini-jack

5. INSTALLATION

5.1. Location, set up and ventilation

The eCOMPACT4BT has been specially designed to be used both as a desktop mixer and a 19" rackmount unit, occupying three rack spaces with optional rack mounting kit 3URMKIT.

The eCOMPACT4BT does not require ventilation due to its low power consumption, however, it is recommended that the unit not be completely enclosed or exposed to extreme temperatures. Fresh air should be allowed to pass through the ventilation holes in the chassis, leaving at least one free rack unit between each device and those installed above and below it in the rack.

If multiple products are installed in the same rack or in a cabinet with closed doors, it is highly recommended to install fans in their upper and lower ends for a forced airflow from the bottom up. This upward air flow will help to dissipate heat generated inside.

5.2. AC connection and powering on

The eCOMPACT4BT is powered by alternating current (AC) through its external power supply: 100-240 VAC, 50-60 Hz. This external power supply has several interchangeable connectors: American, European, British and Chinese.

On the rear panel, the power on/off switch is next to the external power supply connector. On the front panel, a **POWER** LED lights up when the unit is running.

To avoid buzzing, do not allow the external power supply cable to intertwine with and run parallel to the audio shielded cables.

6. FRONT PANEL

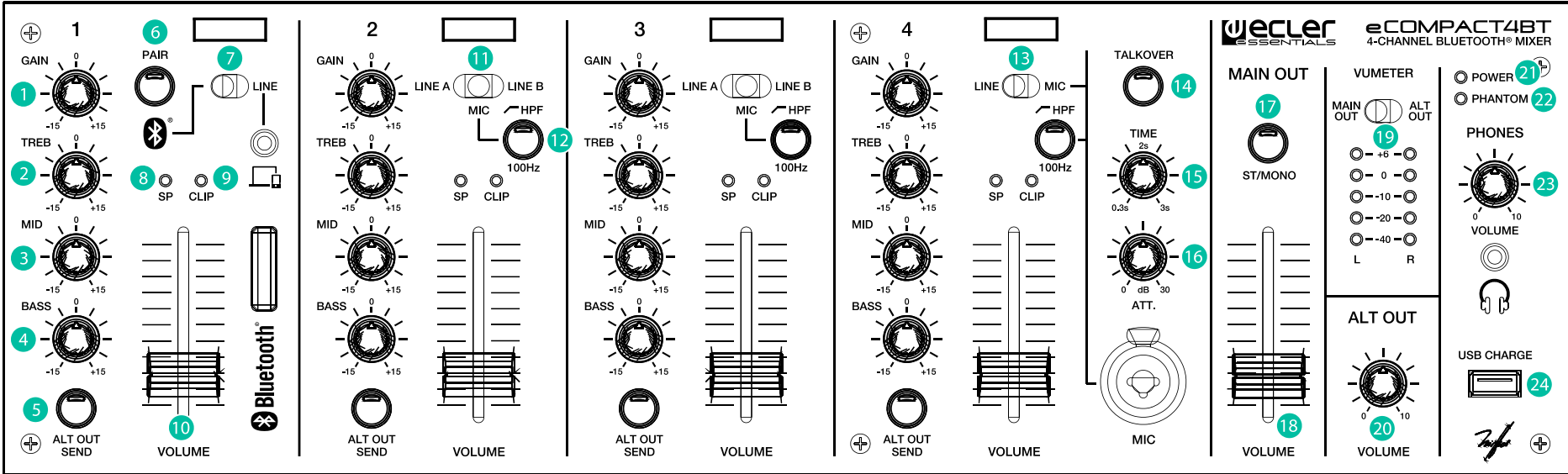

1. **GAIN:** gain control of the channel input signal. Available on all 4 mixing channels.
2. **TREB:** high frequency control. Available on all 4 mixing channels.
3. **MID:** mid frequency control. Available on all 4 mixing channels.
4. **BASS:** low frequency control. Available on all 4 mixing channels.
5. **ALT OUT SEND:** switch to send the channel to the ALT OUT mix bus. Allows to create a sub-mix of selected channels, with independent volume control.
6. **PAIR:** pairing switch for Bluetooth® connection
7. **BLUETOOTH® - LINE:** source selector (channel 1 audio source, Bluetooth® or LINE input). The LINE input features a mini-jack connector on front panel.
8. **SP:** signal presence LED indicator. The green LED lights up or flashes when an audio signal is present on that channel input. Available on all 4 mixing channels.
9. **CLIP:** signal clipping LED indicator. The red LED lights up or flashes when the audio signal selected on that channel is clipping. Adjust the channel GAIN. Available on all 4 mixing channels.
10. **VOLUME:** channel volume. Available on all 4 mixing channels.
11. **LINE A – MIC – LINE B:** audio source selector for channels 2 and 3; LINE A input, LINE B input or MIC input.
12. **HPF:** high-pass filter for MIC input, with fixed 100 Hz cut-off frequency.
13. **LINE – MIC:** audio source selector for channel 4; MIC input or LINE input. The MIC input features a combo connector (XLR-TRS jack) on front panel.
14. **TALKOVER:** channel 4 Talkover assign switch - audio signal with priority over the main mix bus.
15. **TIME:** signal return time adjustment on the mixing bus. 0.3 to 3 seconds.
16. **ATT:** signal attenuation adjustment on the mixing bus. From 0 dB (no attenuation) to 30 dB.
17. **ST/MONO:** MAIN OUT stereo/mono switch.
18. **MAIN OUT VOLUME:** MAIN OUT volume control.
19. **MAIN OUT – ALT OUT VUMETER:** MAIN OUT / ALT OUT signal selector for VU-meter LED indicators.
20. **ALT OUT VOLUME:** ALT OUT volume control.
21. **POWER:** power LED indicator.
22. **PHANTOM:** phantom power LED indicator.
23. **PHONES VOLUME:** volume control for the PHONES OUT mini-jack connector on front panel.
24. **USB CHARGE:** USB connector for charging mobile devices (charge-only port, no file reading from USB media)

7. BACK PANEL

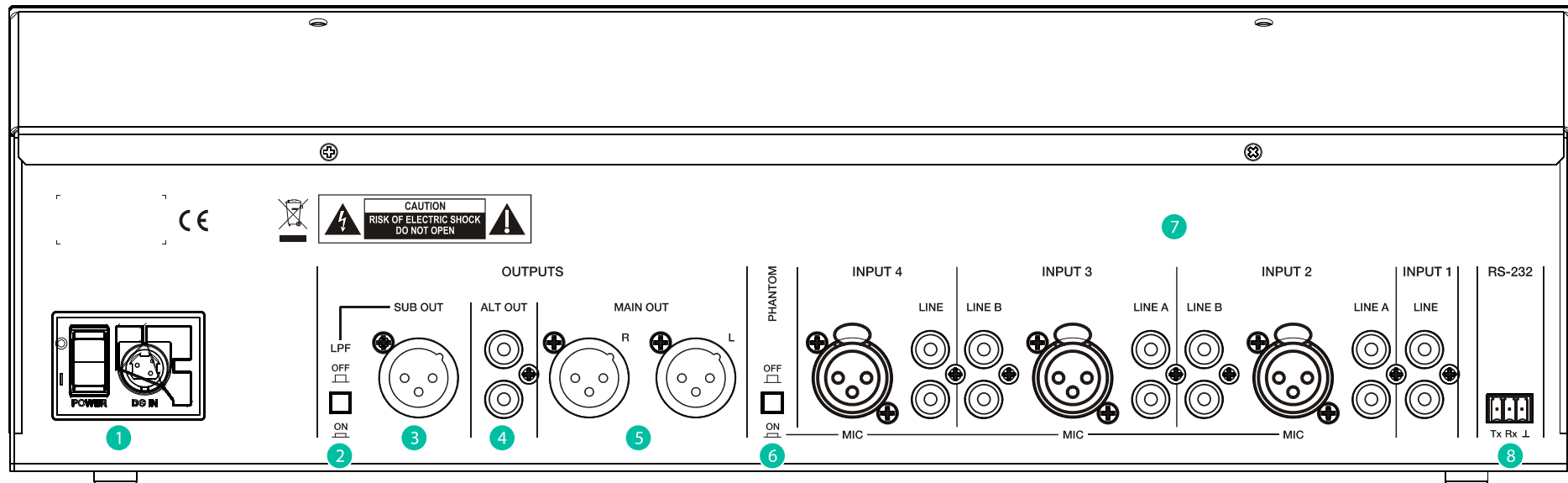

1. **POWER:** unit's power switch. Next to it is the external power supply connector and a tab for securely fastening the power supply cable.
2. **LPF:** SUB OUT low-pass filter switch. Filter with fixed cut-off frequency of 150 Hz.
3. **SUB OUT:** balanced mono output with XLR connector.
4. **ALT OUT:** unbalanced stereo output with RCA connectors.
5. **MAIN OUT:** balanced stereo output with XLR connectors.
6. **PHANTOM:** phantom power (48 VDC) switch for microphone inputs.
7. **INPUTS 1 - 4:** mixing channel audio inputs. Balanced XLR connection for MIC inputs, and unbalanced RCA connection for LINE inputs.
8. **RS-232:** serial communication port for troubleshooting (technical service department).

8. CONNECTIONS

We recommend turning off all devices or putting them into standby mode before making audio connections, whether they are input devices such as audio sources or devices connected to mixer outputs such as power amplifiers.

When connecting a new audio device to the mixer inputs, if the mixer is turned on, it is recommended to set the channel volume control to minimum, and to increase this value until a desired mix level is reached.

Failure to follow these recommendations may result in loud noises that could damage the connected devices or your hearing.

8.1. Audio Input Connections

The eCOMPACT4BT features the following audio inputs, with the following connection types:

- **INPUT 1: unbalanced stereo line input**, with RCA connectors on rear panel and 3.5 mm stereo mini-jack connector on front panel. Bluetooth® wireless audio connection ([see chapter Bluetooth® connection for more information on how to connect a Bluetooth® device](#)). Use one of the line input connectors to connect the audio source.

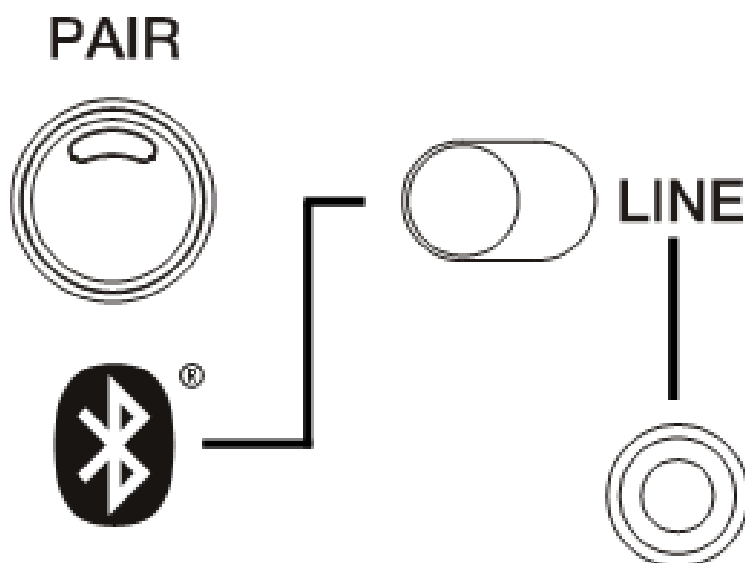

1. Channel 1 audio source selector and mini-jack connector on front panel

- Dual RCA connector: connect your stereo sound source (CD player, smartphone, radio tuner, streaming player, etc.) directly using a cable that delivers the left (L) and right (R) channels to the unit's white and red RCA connectors, respectively.

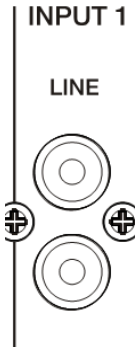

2. Rear panel input 1 RCA connectors

- **INPUT 2 and INPUT 3: unbalanced stereo** line inputs with RCA connectors. **Mono and balanced** microphone inputs with 3-pin XLR connector. All of them on the rear panel.

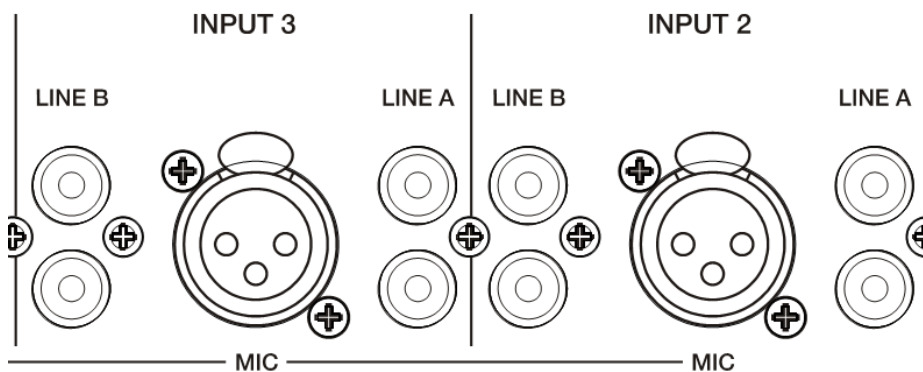

3. INPUT 2 and 3 connections on rear panel

- 3-pin XLR connector:
 - Hot or direct signal > Pin 2
 - Cold or inverted signal > Pin 3
 - Ground > Pin 1

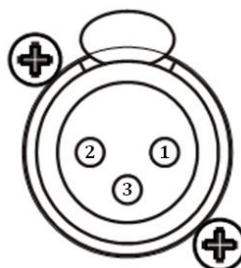

4. 3-pin XLR connector

- **INPUT 4: mono and balanced** microphone input, with 3-pin XLR connector on rear panel and COMBO connector on front panel. **Unbalanced stereo** line input with RCA connectors on rear panel.

- **COMBO connector:**

	XLR	TRS jack
• Hot or direct signal	> Pin 2	Tip
• Cold or inverted signal	> Pin 3	Ring
• Ground	> Pin 1	Sleeve

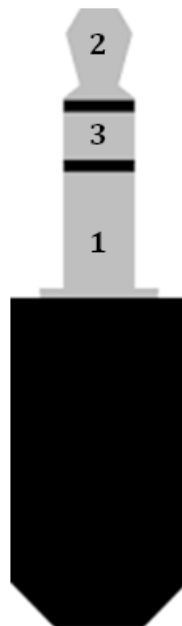

5. TRS jack connector

On the rear panel of the unit, a PHANTOM ON/OFF switch allows supplying inputs 2 to 4 with phantom power (48 VDC) for microphones that require it, usually condenser mics.

8.2. Bluetooth® connection

eCOMPACT4BT has a Bluetooth® wireless audio connection (class 1, range approx. 25 meters in ideal conditions) through which you can connect mobile devices such as smartphones or tablets for audio playback.

To connect:

1. On channel 1, select the Bluetooth® input, indicated by the  logo, see figure1. The PAIR LED will start flashing.
2. On your mobile device, go to the Bluetooth® settings, and select the eCOMPACT4BT device. No PIN required to pair.
3. Once paired, the PAIR LED will stay on.

To unpair a device, press and hold the PAIR button for 2 sec. The Bluetooth® connection will be available again to pair another device.

If you select the line input with the switch on channel 1 when a Bluetooth® connection is established, the wireless connection will not be lost. With the switch, you can re-select the channel 1 Bluetooth® input and the device will remain paired.

8.3. Audio output connections

The eCOMPACT4BT has the following audio outputs, with the following connection types:

- **MAIN OUT:** main output. **Balanced stereo** line outputs with 3-pin XLR connector on rear panel.

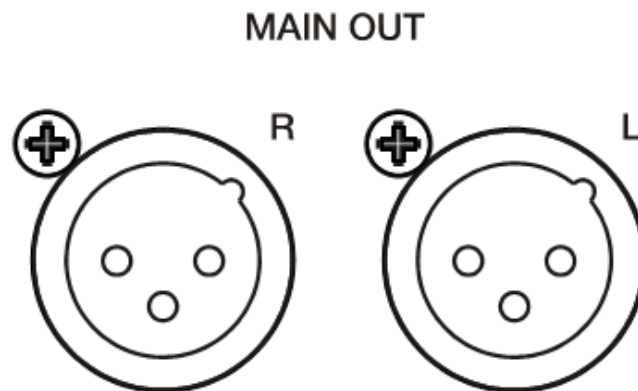

6. MAIN OUT connectors

- 3-pin XLR connector:

- Hot or direct signal > Pin 2
- Cold or inverted signal > Pin 3
- Ground > Pin 1



7. MAIN OUT 3-pin XLR connector

Note: the circuit emulates a balancing transformer, so if you want to use the MAIN OUT in unbalanced mode, the unused output pin must be short-circuited to ground. Otherwise, the output signal will not have the right level or quality.

- **ALT OUT:** alternative output or sub-mix. **Unbalanced stereo** line output with RCA connectors on rear panel.

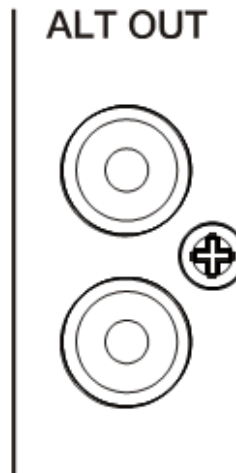

8. ALT OUT RCA connectors

- **SUB OUT:** sub-bass or auxiliary output (monitor, zone, etc.). **Balanced mono** line output with 3-pin XLR connector on rear panel.

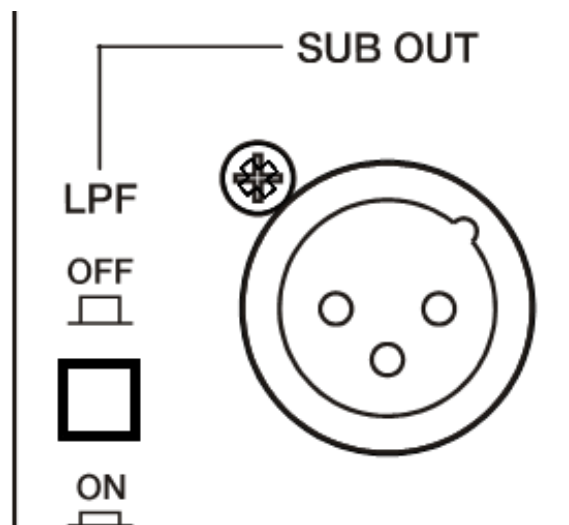

9. SUB OUT sub-bass connector

NOTE: the circuit emulates a balancing transformer, so if you want to use the SUB OUT in unbalanced mode, the unused output pin must be short-circuited to ground. Otherwise, the output signal will not have the right level or quality.

- **PHONES OUT:** headphone output (marked with headphone symbol). **Unbalanced stereo** output with 3.5 mm stereo mini-jack connector and volume control for headphone listening. It is especially useful for listening to the MAIN OUT signal of the unit without disturbing its normal operation.

The headphone volume control is located before the MAIN OUT volume control.

NOTE: adjust the headphone output volume to minimum before connecting the headphones to avoid damaging your hearing.

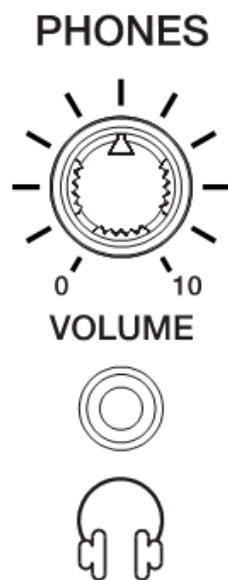

10. Front panel headphone output

If a **balanced** output channel is connected to an amplifier or audio device with **balanced** input, the + (Pin 2), - (Pin 3) and \perp (Pin 1) terminals must be connected point to point between the two devices. If you connect a **balanced** output channel to an amplifier or device with **unbalanced** audio input, leave the - terminal (Pin 3) unconnected.

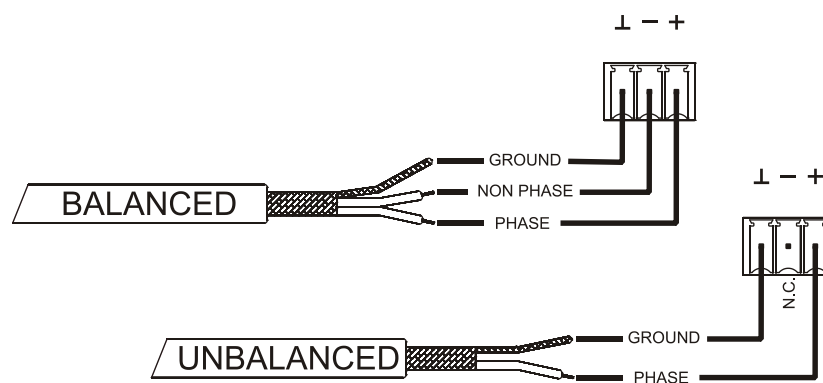

11. Balanced and unbalanced connections

8.4. Other connections

- **USB CHARGE:** type-A USB port for connecting mobile devices. This port is designed **for device charging only** (5 VDC). Very useful if you are using a device connected to eCOMPACT4BT using Bluetooth® connection and need to recharge the battery. This avoids having to connect the Bluetooth® audio device to a distant power outlet at the risk of weakening the Bluetooth® audio transmission.

USB CHARGE

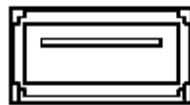

12. USB charging port on front panel

- **RS-232 port:** for troubleshooting by the authorized technical service. It has no use for the user.

9. OPERATION AND USE

9.1. Start-up

Once all connections have been made, turn on the eCOMPACT4BT by pressing the power switch located on the rear panel. The POWER LED will light green.

In a complete audio installation, it is important to power on the equipment according to the following sequence: sound sources (microphones, music players, etc.), mixers, audio processors and finally power amplifiers. To power off, follow the reverse sequence. In this order, the transients produced by switching the devices on or off will not affect the next ones in the chain, remaining inaudible.

9.2. Monitoring

The eCOMPACT4BT is equipped with an audio and visual monitoring system through headphones and VU meter.

The PHONES OUT signal is the same as that sent to MAIN OUT and SUB OUT (main mix bus signal).

You can select the signal to be displayed on the VU meter between the main mix bus signal (present on MAIN OUT and SUB OUT) and the ALT OUT mix bus signal.

9.3. Channel gain and equalization

These controls allow you to adjust input sensitivity level and tone for each channel individually.

After connecting the various audio inputs, the GAIN controls of each input should be used to obtain an optimal signal strength and maximum signal-to-noise ratio, so that they can be used properly as sound sources in the installation. To do this, try to maximize the volume controls of the audio players before adjusting the gain on the eCOMPACT4BT. Use the level indicators on the front of the unit (VU meters) for correct gain adjustment, ensuring that signal peaks are normally in the area near 0 dB (orange area in VU meters) and very exceptionally above it ("red" area, saturation or clipping).

GAIN controls provide a ± 30 dB adjustment range.

The 3-band tone controls (treble, midrange and bass) provide a ± 30 dB range. Be careful not to overload the speakers.

9.4. Channel indicators

Each of the 4 input channels has two indicators. The green SP (*Signal Present*) LED indicates the presence of a signal at the input selected with the active input selector. If this LED does not light up when an audio source is delivering a signal, make sure that the equipment has been properly connected, that the source you want to hear is selected - channel source selection switches -, and/or that the GAIN control is correctly adjusted.

The red CLIP LED indicates a risk of saturating the channel if the recommended signal level is exceeded. This indicator may light up sporadically without risk to the equipment but should never remain on continuously.

The PAIR button LED indicator shows the device pairing status:

- The PAIR LED blinks: Pair mode enabled, the device is visible (from the mobile device Bluetooth® adjustment settings) and ready to establish connection.
- The PAIR LED is on: A Bluetooth® connection already done. The device is paired.
- The PAIR LED is off (but the eCOMPACT4BT device is on): CH1's line input is selected.

9.5. Talkover function

When the Talkover function is activated, the input signal selected for channel 4 has priority over the main mix bus, i.e. when a signal is detected at the priority input (signal level above threshold), the mix bus signal is attenuated at the MAIN OUT and SUB OUT. ALT OUT is not affected.

Note: Talkover is set to -20dB by factory default. However, it can also be set to -30dB by an internal switch. If you wish to change the default setting, [please see chapter CONFIGURATION DIAGRAM for details.](#)

9.6. Outputs

The eCOMPACT4BT has two independent outputs, with their own volume control: MAIN OUT and ALT OUT. It also has a SUB-OUT sub-bass or auxiliary output, which delivers a mono copy of the MAIN OUT signal.

The ALT OUT signal is taken from the mix bus before the Talkover function is triggered, so there is no attenuation by the Talkover function. This output can be used as a recording output – REC OUT – which may or may not include (using ALT OUT SEND) the signal that triggers the Talkover function.

When manipulating the main output level of the mixing console, care must be taken to ensure that the CLIP indicators of the connected power amplifiers are never permanently lit, but at most at the rhythm of the lowest frequencies that reach them.

10. CONSIDERATIONS

10.1. Ground loops

Always be careful not to interconnect grounds from the signal sources entering the mixing console and from all devices connected to its outputs – ground must never come from different devices, otherwise humming could occur and degrade the sound quality.

The cable shields, if connected to the chassis, must never be connected to each other. This prevents the formation of ground loops.

10.2. Background noise

The eCOMPACT4BT mixer has been designed to obtain the lowest possible background noise. Regardless of the electronic design, the background noise will directly depend on the correct use and installation of the unit.

Setting for example a channel FADER to "2" and the MAIN OUT VOL to "10" is not the same as the opposite. In the first case, the signal entering the mixing amplifier is weak, but even so it contains a background noise, so the signal/noise ratio is low (low signal). When the output amplifier equally amplifies both parts as a whole, the output has a very high background noise. In the second case, as the channel FADER is set to maximum, the signal received by the mixing amplifier has a high level and therefore also a high (good) signal/noise ratio, so when this signal reaches the output VOL control and is amplified, the signal/noise ratio remains better than in the previous case.

11. BLOCK DIAGRAM

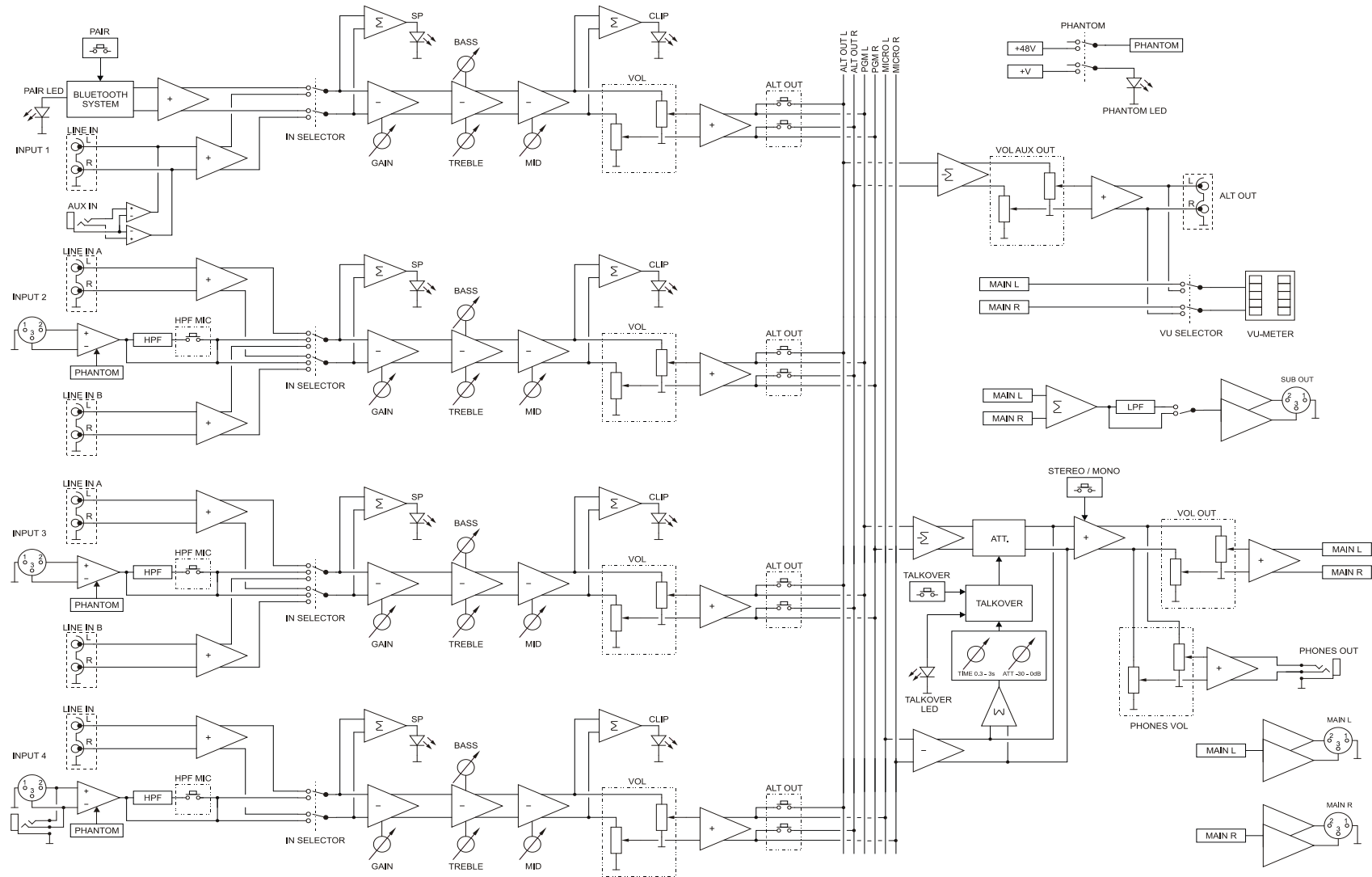

12. CONFIGURATION DIAGRAM

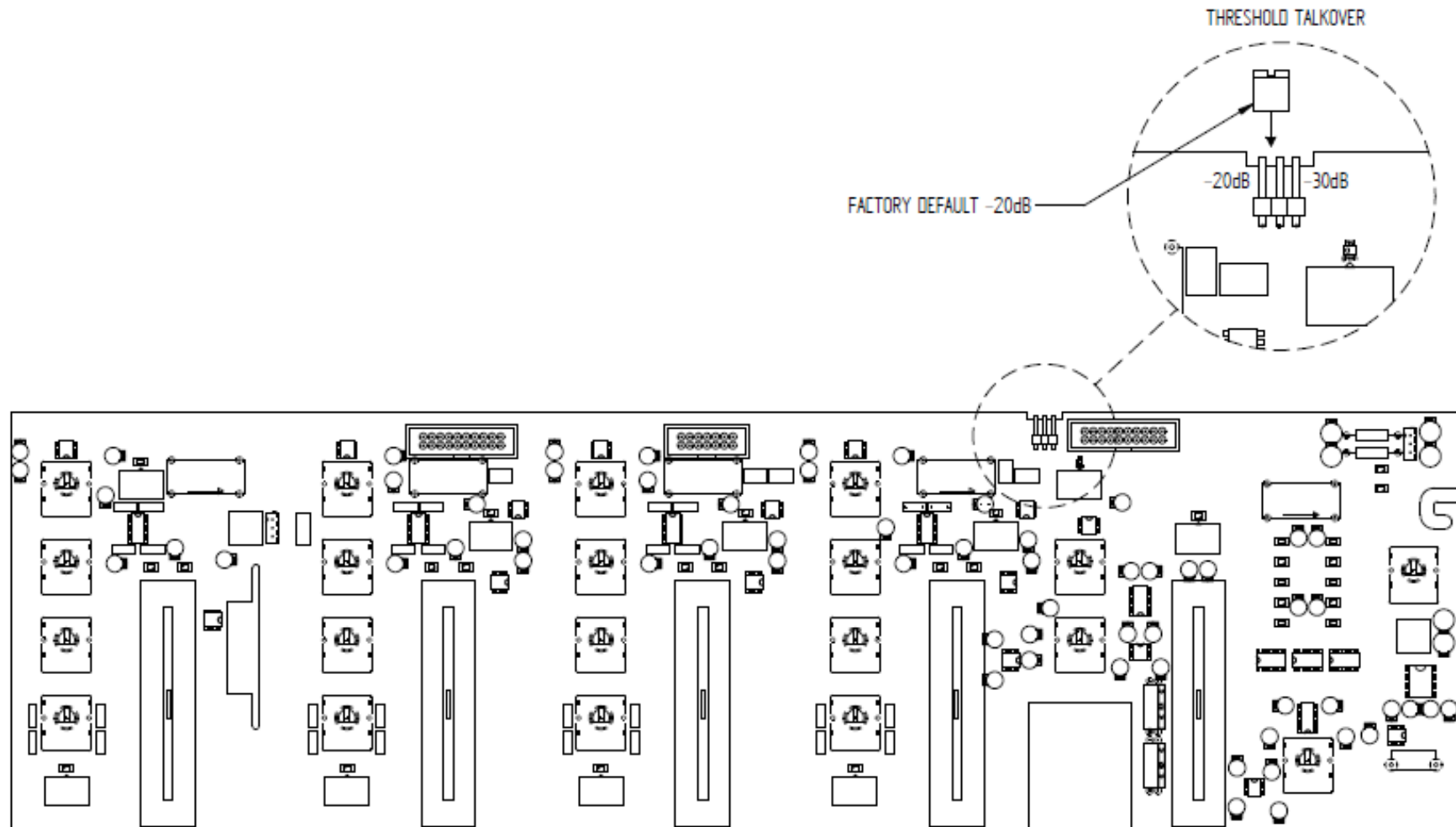

13. TECHNICAL SPECIFICATIONS

eCOMPACT4BT

Input Sensitivity and Input Impedance	
LINE, LINE A, LINE B	0dBV/50k Ω
MICRO (BAL)	-35dBV/>1k Ω
AUX INPUT IN1	-10dBV/316 Ω
BT INPUT	-10dBVFS
Frequency Response	
LINE, LINE A, LINE B	10Hz \div 30kHz, -1dB
MICRO (BAL)	10Hz \div 30kHz, -1dB
AUX INPUT IN1	10Hz \div 30kHz, -1dB
BT INPUT	10Hz \div 30kHz, -1dB
Input Selector	
INPUT 1	BT, LINE + AUX
INPUT 2	LINE A, MICRO, LINE B
INPUT 3	LINE A, MICRO, LINE B
INPUT 4 (TALKOVER)	LINE, MIC
Aux Input (on INPUT 1)	Connected to INPUT1 LINE
Gain control	
GAIN	\pm 15dB
Tone control	
BASS	100Hz, \pm 15dB
MID	2kHz, \pm 15dB
TREBLE	10kHz, \pm 15dB
THD+N	
LINE	<0,03%
MICRO	<0,06%
AUX	<0,03%
BT INPUT	<0,05%
Signal Noise Ratio	
LINE	>100dB
MICRO	>90dB
AUX INPUT IN1	>100dB
BT INPUT	>100dB
CMRR	
BAL INPUTS	>75dB @ 1kHz
MICRO 2-4 High Pass Filter	100Hz, -3dB – 2nd order
Outputs Level	
MAIN OUT	0dBV
SUB OUT	0dBV
ALT OUT	0dBV
HEADPHONES	200mW
Output VU-METER STEREO / MONO	+6dB to -40dB, MAIN OUT or ALT OUT selectable Functional only over MAIN OUT, SUB OUT and HEADPHONES
ALT OUT	Selectable by ALT OUT SEND buttons in each CHANNEL

SUB OUT low pass filter (externally selectable)		140Hz, -3dB – 3rd order
Talkover		
	TIME	0,3 / 3 seg
	ATT	0 / 30 dB
	SENSITIVITY	-20dB (Factory default) / -30dB (internally selectable)
	LED INDICATOR	Orange when TLK TRIGGERED
Signal Present indicators		
	LINE	-40dB
	MICRO	-75dB
Clip indicators (inputs)		+16dB
Phantom voltage (externally selectable)		+48VDC
USB port		+5VDC, only for charging
RS232 port		Only for configuration purposes
BT PAIR Button		Only for UNPAIRING and configuration purposes
DC Power Supply		±17.5 VDC
Mains (with External Power Supply)		100-240VAC + External PSU 17,5VDC
Power consumption (with External Power Supply)		15W
Dimensions		
	Panel	440x132mm
	Depth	125mm
Weight		3,0kg

14. PACKAGE CONTENTS

- eCOMPACT4BT
- 3URMKIT included (rack-mount accessory)
- External power supply
- Adhesive feet for table-top installation
- Quick User Guide and Warranty Card

Ecler Bluetooth® Manager

WINDOWS APPLICATION

Configuration tool for Ecler Bluetooth® devices



USER MANUAL

15. Ecler Bluetooth® Manager PRODUCT OVERVIEW

Ecler Bluetooth Manager is a Windows® application that allows configuring Bluetooth® parameters, such as the Bluetooth® name shown in compatible devices or the password for pairing.

15.1 Versions

- V1.0 [JAN19] – Latest release



15.2 Compatible Devices

- eCOMPACT4BT



15.3 Operation

- **eCOMPACT4BT:**
 1. Connect the RS-232 cable to the RS-232 PORT on the eCOMPACT4BT.
 2. Change the INPUT 1 SELECTOR to BT.
 3. POWER OFF the device and POWER ON it again while pressing PAIR BUTTON. When POWERED ON, the BT PAIR LED will remain ON – BLUE fixed. This enables the USER to configure the Bluetooth® parameters.
 4. On the computer, open Ecler Bluetooth Manager Application. It will show this interface:



5. Select the correct COM Port and click on READ button. Verify that the information about NAME and PIN of the device appear on the screen. This information must be like the following (factory defaults):



6. Change the NAME and PIN as you wish, and click on WRITE button.



7. POWER OFF and ON the device to apply changes.



All product characteristics are subject to variation due to production tolerances. **NEEC AUDIO BARCELONA S.L.** reserves the right to make changes or improvements in the design or manufacturing that may affect these product specifications

For technical queries contact your supplier, distributor or complete the contact form on our website, in [Support / Technical requests](#).

Motors, 166-168 08038 Barcelona - Spain - (+34) 932238403 | information@ecler.com | www.ecler.com