

eLPA2-650

LOW IMPEDANCE

Stereo Lightweight Amplifier

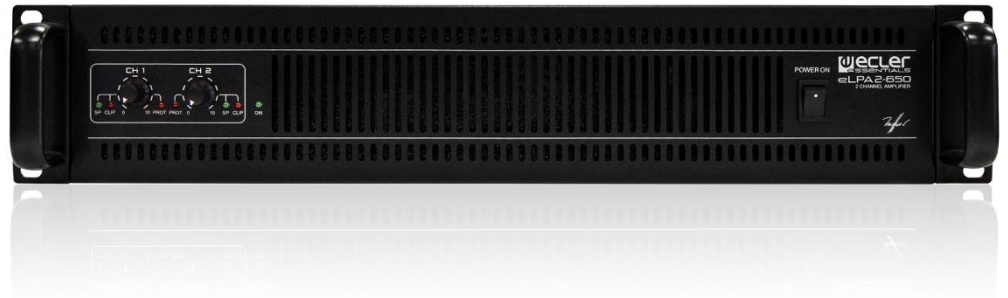

PRODUCT OVERVIEW

eLPA2-650 is a stereo amplifier delivering 2 x 630 WRMS @ 4Ω. eLPA series brings all the classic, well-known reliability and amplification quality of ECLER to a new light-weight format that is versatile and affordable.

KEY FEATURES

- 2 analogue audio inputs x 2 powered audio outputs
- Ultra light technology
- Efficient progressive ventilation system
- Rotary input attenuation controls that are easily accessible on the front panel
- POWER ON, SIGNAL, CLIP y PROTECT LED indicators
- Efficient short-circuit, overheat and DC signal protection system to prevent damage to the amplifier and/or the loudspeakers connected to it
- Permanently activated built-in anti-clip circuit
- Balanced inputs via XLR3 connectors
- Amplified outputs with terminal-type connectors and Speakon® connectors

APPLICATIONS

- Retail
- Hospitality
- Leisure

CERTIFICATIONS

- EN60065:2014
- EN55103-1:2009
- EN55103-2:2009
- 2006/95/EC
- 2004/108/CE

TECHNICAL SPECIFICATIONS

eLPA2-650

1 Channel @ 4 Ω	630 WRMS
1 Channel @ 8 Ω	340 WRMS
All Channels @ 4 Ω	610 WRMS
2 Bridged Channels @ 8 Ω	1220 WRMS
Input connectors	XLR3 connectors
Signal present indicator	-40dB
Gain	0,775V/1V/32dB
Frequency response (-1dB, -3dB)	20Hz – 25kHz
THD+N @ 1kHz Full Power	<0,1%
S+S/N 20Hz-20kHz @ 1W/4 Ω	>85dB
CMRR	>55dB
Output connectors	Speakon & binding posts
Mains Voltage	100-240VAC, 50/60Hz
Power consumption (1/8 power @ 4ohm)	223,5 W
Power consumption (1/3 power @ 4ohm)	542,0 W
Power consumption (Idle)	32,0 W
Dimensions WxDxH (Handle excluded)	482,6 x 266 x 88 mm
Weight	6,00 kg

MECHANICAL DIAGRAM



Ecler eLPA2-650,950,1400 Mechanical Diagram

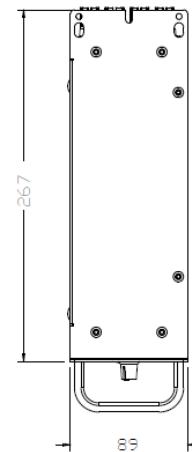
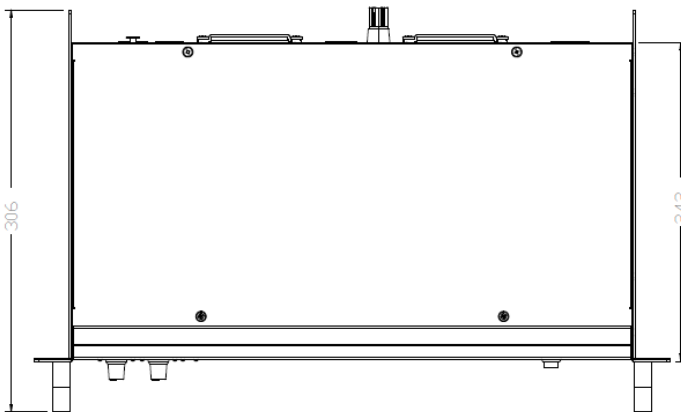
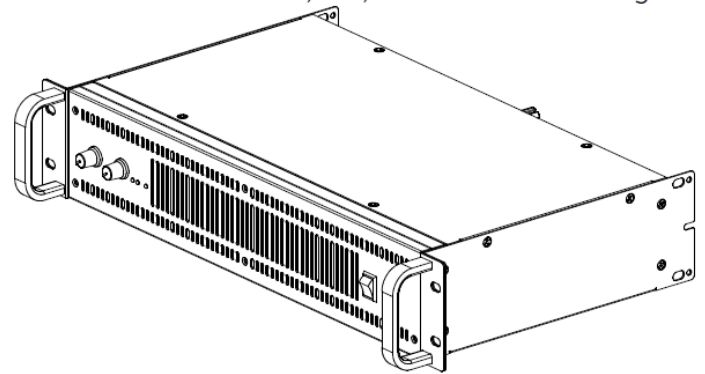
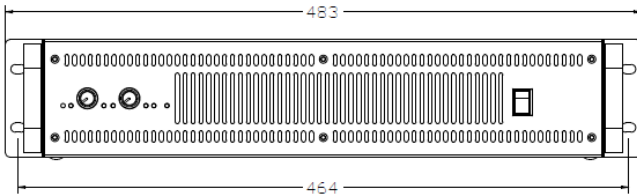

61-1107-0100

www.ecler.com



All product characteristics are subject to variation due to production tolerances. **NEEC AUDIO BARCELONA S.L.** reserves the right to make changes or improvements in the design or manufacturing that may affect these product specifications

For technical queries contact your supplier, distributor or complete the contact form on our website, in [Support / Technical requests](#).

Motors, 166-168 - 08038 Barcelona - Spain - (+34) 932238403 | information@ecler.com | www.ecler.com