

DUO-NET PLAYER

SOUND SOURCES

Dual Streaming & Media Audio Player



USER MANUAL

INDEX

1	IMPORTANT REMARK.....	3
2	IMPORTANT SAFETY INSTRUCTIONS.....	3
3	IMPORTANT NOTE.....	5
4	INTRODUCTION.....	5
5	INSTALLATION.....	6
	5.1 <i>Location, set up, ventilation.....</i>	6
	5.2 <i>AC connection and powering on.....</i>	7
	5.3 <i>Audio output connections.....</i>	7
	5.4 <i>ETHERNET port for programming and control.....</i>	8
	5.4.1 <i>Factory Preset Network settings.....</i>	8
	5.5 <i>GPI remote control ports.....</i>	8
	5.6 <i>RS-232 remote control port.....</i>	9
6	FRONT PANEL.....	10
7	STARTUP.....	11
	7.1 <i>Local media playback.....</i>	11
	7.1.1 <i>Playing files stored on USB storage devices.....</i>	11
	7.1.2 <i>Playing files stored on SD/SDHC memory cards.....</i>	12
	7.2 <i>Playing networked (LAN) files.....</i>	12
	7.3 <i>Playing (Internet) streams.....</i>	13
	7.4 <i>Main menu.....</i>	14
	7.5 <i>Player menu.....</i>	15
8	REMOTE CONTROL.....	16
9	CLEANING.....	16
10	DIAGRAMS and FUNCTION LIST.....	17
11	BLOCK DIAGRAM.....	18
12	TECHNICAL CHARACTERISTICS.....	19
13	TP-NET PROTOCOL INTRODUCTION.....	22
14	DUO-NET PLAYER AUDIO PLAYER & STREAMING RECEIVER.....	25
15	ERROR CODES FOR ECLERNET DEVICES.....	31
	15.1 <i>COMMON ERROR CODES (to all EclerNet - TP-NET compatible devices).....</i>	31
	15.2 <i>DUO-NET PLAYER SPECIFIC ERROR CODES.....</i>	31
16	HOW TO IDENTIFY INTERNET RADIO URL STREAMS.....	32
	16.1 <i>How to discover streaming URLs included in websites:.....</i>	32
	16.2 <i>Playing internet radios via AirPlay (ePLAYER1):.....</i>	37

1 IMPORTANT REMARK



WARNING: SHOCK HAZARD - DO NOT OPEN
AVIS: RISQUE DE CHOC ÉLECTRIQUE - NE PAS OUVRIR



The lightning flash with arrowhead symbol, within an equilateral triangle, is intended to alert the user to the presence of uninsulated “dangerous voltage” within the product’s enclosure that may be of sufficient magnitude to constitute a risk of electric shock to persons.



The exclamation point within an equilateral triangle is intended to alert the user to the presence of important operating and maintenance (servicing) instructions in the literature accompanying the appliance.

WARNING (If applicable): The terminals marked with symbol of “” may be of sufficient magnitude to constitute a risk of electric shock. The external wiring connected to the terminals requires installation by an instructed person or the use of ready-made leads or cords.

WARNING: To prevent fire or shock hazard, do not expose this equipment to rain or moisture.

WARNING: An apparatus with Class I construction shall be connected to a mains socket-outlet with a protective earthing connection.

2 IMPORTANT SAFETY INSTRUCTIONS

1. Read these instructions.
2. Keep these instructions.
3. Heed all warnings.
4. Follow all instructions.
5. Do not use this apparatus near water.
6. Clean only with dry cloth.
7. Do not block any ventilation openings. Install in accordance with the manufacturer’s instructions.

8. Do not install near any heat sources such as radiators, heat registers, stoves, or other apparatus (including amplifiers) that produce heat.
9. Do not defeat the safety purpose of the polarized or grounding type plug. A polarized plug has two blades with one wider than the other. A grounding type plug has two blades and a third grounding prong. The wide blade or the third prong are provided for your safety. If the provided plug does not fit into your outlet, consult an electrician for replacement of the obsolete outlet.
10. Protect the power cord from being walked on or pinched particularly at the plugs, convenience receptacles, and at the point where they exit from the apparatus.
11. Only use attachments/accessories specified by the manufacturer.
12. Unplug the apparatus during lightning sorts or when unused for long periods of time.
13. Refer all servicing to qualified personnel. Servicing is required when the apparatus has been damaged in any way, such as power supply cord or plug is damaged, liquid has been spilled or objects have fallen into the apparatus, the apparatus has been exposed to rain or moisture, does not operate normally, or has been dropped.
14. Disconnecting from mains: Switching off the POWER switch all the functions and light indicators of the amplifier will be stopped, but fully disconnecting the device from mains is done unplugging the power cord from the mains input socket. For this reason, it always shall remain readily operable.
15. Equipment is connected to a socket-outlet with earthing connection by means of a power cord.
16. The marking information is located at the bottom of apparatus.
17. The apparatus shall not be exposed to dripping or splashing and that no objects filled with liquids, such as vases, shall be placed on apparatus.

NOTE: *This equipment has been tested and found to comply with the limits for a Class A digital device, pursuant to part 15 of the FCC Rules. These limits are designed to provide reasonable protection against harmful interference when the equipment is operated in a commercial environment. This equipment generates, uses, and can radiate radio frequency energy and, if not installed and used in accordance with the instruction manual, may cause harmful interference to radio communications. Operation of this equipment in a residential area is likely to cause harmful interference in which case the user will be required to correct the interference at his own expense.*



WARNING: This product must not be discarded, under any circumstance, as unsorted urban waste. Take to the nearest electrical and electronic waste treatment centre.

NEEC AUDIO BARCELONA, S.L. accepts no liability for any damage that may be caused to people, animal or objects due to failure to comply with the warnings above.

3 IMPORTANT NOTE

Thank you for choosing our Ecler **DUO-NET PLAYER Dual Streaming & Media Audio Player!**

It is **VERY IMPORTANT** to carefully read this manual and to fully understand its contents before any connection in order to maximize your use and get the best performance from this equipment.

To ensure optimal operation of this device, we strongly recommend that its maintenance be carried out by our authorised Technical Services.

All ECLER products are covered by warranty, please refer to www.ecler.com or the warranty card included with this product for the period of validity and conditions.

4 INTRODUCTION

The DUO-NET PLAYER is a dual audio player/streaming receiver, fully compatible with EclerNet Manager, with the following main features:

- 2 balanced stereo audio outputs: PLAYER A and PLAYER B. Euroblock connector (stereo/mono selection for each output via software).
- 2 independent integrated players, each linked to a balanced stereo output.
- Compatible with MP3, ogg, AAC, WAV and FLAC audio formats.
- 1 USB port and 1 SD card slot for local media access.
- RJ45 Ethernet interface for EclerNet and TP-NET communication, as well as receiving audio streaming from Internet and networked media.
- Fully programmable and controllable through EclerNet Manager, a Windows® application (point to point or via Ethernet).
- System of customizable remote control UCPs (User Control Panels), compatible with "client" devices: computers, tablets, smartphones, etc. (iOS®, Windows® and Android®).
- Compatible with the TP-NET integration protocol via RS-232 and Ethernet interfaces.
- 4 GPI ports (General Purpose Inputs, 0-10VDC), to trigger events directly (4 separate triggers) or using 4-bit combinations (up to 15 separate triggers).
- IR remote control for basic user management.
- Universal external power supply with interchangeable connectors (American, European, British and Chinese).
- Priorities management: messages or other audio files (announcements, warnings, etc.) can override the audio program.

- Internal clock with up to 84h autonomy (without AC adapter) and automatic synchronization with NTP services*.
- Front panel controls and indicators:
 - LCD display.
 - Digital encoder to navigate in the menus and set the parameters.
 - 7 backlit keys with pre-assigned function: MENU, PLAYER A, PLAYER B, STOP, PLAY/PAUSE, NEXT/FF and PREV/RW.
 - 5 backlit keys with programmable function: F1, F2, F3, F4 and F5.

To setup the DUO-NET PLAYER, you have to use the EclerNet Manager** application. See the EclerNet Manager Application manual at www.ecler.com for more information.

* For those applications where punctuality is a must, Ecler strongly recommends to use NTP services.

**The EclerNet Manager application is available for download from www.ecler.com.

5 INSTALLATION

5.1 Location, set up, ventilation

The PLAYER DUO-NET has been especially designed to be installed in a standard 19" rack, taking up 1U.

In professional installations it is highly recommended to locate the device in the same rack as the sound sources.

Since its power consumption is very low, forced ventilation is not necessary. However, avoid exposing the device to extreme temperature and the environment in which it is placed should be as dry and clean (no dust) as possible

5.2 AC connection and powering on

DUO-NET is powered by alternating current through its external power supply: 100-240 VAC and 50-60 Hz. This external PSU has interchangeable connectors: American, European, British and Chinese.

The work environment must be dry and completely free of dust. Do not expose the appliance to falling water or splashes. Do not place objects with liquid or naked flame sources, such as candles, on top.

If any intervention and / or connection-disconnection is required, the power must be disconnected previously. Inside the device there are no manipulable elements by the user. The power cable must not be mixed with the audio cables, as this could cause buzzing.

5.3 Audio output connections

The DUO-NET PLAYER features 2 separate balanced stereo outputs (one for each player) on the rear panel.

Signal outputs use 3-position screw terminal blocks (Euroblocks). The wiring is as follows:

- Hot or direct signal > Terminal +
- Cold or inverted signal > Terminal -
- Ground > Terminal ⊥

For unbalanced connection, don't connect the terminal -.

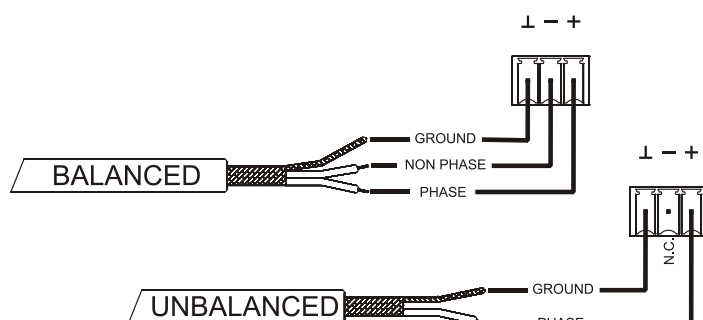

5.4 ETHERNET port for programming and control

A RJ45 connector (13) allows connecting the device to an Ethernet network:

- Management from the EclerNet Manager application. See the EclerNet Manager Application manual at www.ecler.com for more information.
- Direct connection (point-to-point) of a computer/WpaSCREEN unit to a DUO-NET PLAYER unit.
- One or more DUO-NET units and other EclerNet devices can be connected to a computer and one or more WpaSCREEN units in order to create an EclerNet project through an Ethernet network composed of one or more Ethernet switches and Ethernet network cabling.
- Connecting to third party devices for remote management and integration to other electronic systems (Crestron, AMX, Vity, Medialon, etc. Trademarks registered by their manufacturers). Used protocol: Ecler TP-NET. [Refer to the TP-NET protocol manual for more information.](#)

5.4.1 Factory Preset Network settings

The factory default network settings for EclerNet Manager compatible devices are as follows:

- IP: 192.168.0.100
- Mask: 255.255.255.0
- Gate: 192.168.0.1
- UDP Port: 2210

5.5 GPI remote control ports

The rear panel of the DUO-NET PLAYER offers 4 GPI inputs (14) for 0-10VDC continuous voltage control. Each of these inputs can be connected to an external physical device (contact closure, switch, sensor, etc.) and assigned to a DUO-NET PLAYER function, such as:

- MUTE or SOLO On/Off using a switch or contact closure
- Recalling a *preset* using a switch or contact closure
- Triggering pre-recorded messages with or without priority
- Etc.

GPI connectors use 3-position screw terminal blocks (Euroblocks). The wiring is as follows:

- Power > Terminal +
- GPI terminal > Terminal 1, 2, 3 or 4
- Ground > Terminal ⊥

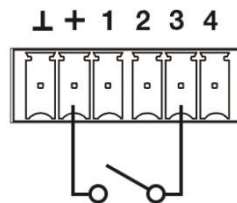

Example of connection: GPI 3

Connecting cables can be up to 500 meters long with a minimum section of 0.5 mm².

Please consult your ECLER dealer or www.ecler.com about the Wpa series remote control wall panels and other accessories available for connection to the GPI/REMOTE/VCA ports.

5.6 RS-232 remote control port

The rear panel RS-232 port allows serial communication between an external device and a DUO-NET PLAYER unit. This connection uses the TP-NET protocol syntax so the external device can obtain the value of any of the DUO-NET PLAYER parameters (using "GET" commands) and/or modify these values ("SET" commands). [Refer to the TP-NET protocol manual for more information.](#)

The serial connection must meet the following characteristics:

Baud rate: 57600 (fixed, no auto negotiation)

Data bits: 8

Parity: None

Stop bits: 1

Flow control: None

RS-232 - DB9 WIRING	
RS-232	DB9
Tx	Terminal 2 (RxD)
Rx	Terminal 3 (TxD)
Gnd	Terminal 5 (Signal Gnd)

6 FRONT PANEL

The following elements are available on the DUO-NET PLAYER front panel:

- USB 2.0 port with LED indicator showing data activity (1): to play local media (audio content). Up to 32GB. FAT16/32 format.
- SD/SDHC slot with LED indicator showing data activity (2): to play local media (audio content). Up to 32GB. FAT16/32 format.
- IR receiver (3): to control the basic functions of the device from a remote control (included).
- DATA LED (4): shows data reception via the (Internet or LAN) network.
- PLAYER A key (5): displays PLAYER A current settings (URL, tags, playing time, random/repeat mode, etc.) and assigns the other keys (PLAY/PAUSE, STOP, NEXT, PREV and 5 programmable keys) to the PLAYER A.
- PLAYER B key (6): same as above, but for PLAYER B.
- LCD display (7): displays menus, player information, etc.
- CONTROL digital encoder (8): to navigate through menus, select parameters, access to sub-menus, etc.
- MENU key (9): allows access to the main menu of the device. Returns to the main menu from a sub-menu or exit the main menu (if pressed from the main menu).
- PREV/RW key (⏮): skips to the previous song in the player playlist. Hold the key pressed for fast rewind (RW) on the same track.
- STOP key (■): stops the current playing.
- PLAY/PAUSE key (⏪ ▶): starts/stops playback of the selected playlist/track.
- NEXT/FF key (⏭): skips to the next song in the player playlist. Hold the key pressed for fast forward (FW) on the same track.
- Programmable keys (F1-F5) (11): trigger the event scheduled for each key. By default, F1 key loads files from the USB device inserted into the player. F2 key loads the files from the SD card inserted into the player. F1 to F5 keys have many other event triggering options (selection of audio tracks/local or networked playlists, selection of playlists/Internet streams, playback of pre-recorded messages, setup preset recall, etc.), programmable through EclerNet Manager Application. See the EclerNet Manager Application manual at www.ecler.com for more information..

7 STARTUP

The DUO-NET PLAYER has been designed so that it can be used as a local media player, without additional software. However, to use it to its full potential, it has to be integrated into an EclerNet device network. That is why Ecler strongly recommends using the DUO-NET PLAYER with the EclerNet Manager application to enjoy all its features. Please refer to the EclerNet Manager Application manual at www.ecler.com to know all the functionality it offers.

7.1 Local media playback

7.1.1 Playing files stored on USB storage devices

Insert a USB device containing audio files in the USB port (1). Then select PLAYER A or B (keys 5 or 6) to playback the content. By default, the F1 key (11) is assigned to USB content playback. So you just have to press F1 to access content stored on the USB device. The display shows the selected media (USB). Press ▶ in the transport bar (10) to start playing content.

The LED next to the USB port starts flashing (blue) indicating that an audio file on this media is played back. You can check the audio output from the selected player by looking at the level meter (vertical bar) on the display of the corresponding player.



DUO-NET PLAYER playing a file in PLAYER A

Turning the CONTROL digital encoder (8) adjusts the volume of the selected player. Pressing it mutes (MUTE ON) the player.

By default, the display shows summary information for both players. Pressing once a player key (5 or 6) gives you access to detailed information about the current playback. Pressing it a second time leads you to another level of information. Pressing it a third time returns to the screen with information concerning both players (A and B).



Detailed information about the current playback and playlist

7.1.2 Playing files stored on SD/SDHC memory cards

Insert a SD/SDHC card containing audio files in the slot (2). Then select PLAYER A or B (keys 5 or 6) to playback the content. By default, the F2 key (11) is assigned to SD/SDHC card content playback. So you just have to press F2 to access content stored on the card. The display shows the selected media (SD). Press ▶ in the transport bar (10) to start playing content. The LED next to the SD/SDHC card slot starts flashing (blue) indicating that an audio file on this media is played back. You can check the audio output from the selected player by looking at the level meter (vertical bar) on the display of the corresponding player.

Turning the CONTROL digital encoder (8) adjusts the volume of the selected player. Pressing it mutes (MUTE ON) the player.

By default, the display shows summary information for both players. Pressing once a player key (5 or 6) gives you access to detailed information about the current playback. Pressing it a second time leads you to another level of information. Pressing it a third time returns to the screen with information concerning both players (A and B).

7.2 Playing networked (LAN) files

The DUO-NET PLAYER can playback audio files from remote devices on the same local network (LAN). To access these files, you must previously create one or more playlists using EclerNet Manager Application. Please refer to the EclerNet Manager Application manual at www.ecler.com for more information on how to create playlists on networked devices.

Once playlists are created, the DUO-NET PLAYER gives you local access to such content. To access them, first make sure the DUO-NET PLAYER is connected to the same local network as the device the content is stored on. Then select the player A or B where to load the playlist (keys 5 or 6). Next press the selected player key again to access detailed information. At this point, press the MENU key (9). Within the PLAYER menu, select LOAD PLAYLIST. To do this, press the digital encoder (8).

Turning the encoder allows to browse the 99 playlists a DUO-NET PLAYER can memorize*. Select the desired playlist by pressing the encoder. Press ▶ to start playing content. Press MENU →EXIT to exit the menu.



Loading a playlist

*The DUO-NET PLAYER locally stores Internet or local network addresses. It never stores audio content.

7.3 Playing (Internet) streams

The DUO-NET PLAYER can play Internet audio streams. To access these files, you must previously create one or more playlists using EclerNet Manager application. Please refer to the EclerNet Manager Application manual at www.ecler.com for more information on how to create playlists on networked devices.

Once playlists are created, the DUO-NET PLAYER gives you local access to such content. To access them, first make sure the PLAYER DUO-NET is configured to access the Internet (IP address, subnet mask and gateway). Then select the player A or B where to load the playlist (keys 5 or 6). Next press the selected player key again to access detailed information. At this point, press the MENU key (9). Within the PLAYER menu, select LOAD PLAYLIST. To do this, press the digital encoder (8). Turning the encoder allows to browse the 99 playlists a DUO-NET PLAYER can memorize*. Select the desired playlist by pressing the encoder. Press ▶ to start playing content. Press MENU →EXIT to exit the menu.

*The DUO-NET PLAYER locally stores Internet or local network addresses. It never stores audio content.

7.4 Main menu

Press the MENU key from the screen with information concerning both players (A and B) to access the main menu. The following sub-menus appear in this menu:

- **LOAD PRESET:** allows you to load presets or configuration memories (up to 20) previously programmed in EclerNet Manager (see EclerNet Manager manual for more information).
- **DISPLAY:** LCD adjustment settings.
 - **LCD MODE:** display operation in idle or low power consumption mode.
 - **ON:** the display is always lit
 - **Dimmed:** the display brightness dims after a few seconds without using the unit controls. Pressing any key returns the set brightness level.
 - **OFF:** the display turns off after a few seconds without using the unit controls. All LEDs and keys also turn off except the selected PLAYER (A or B).
 - **BACKLIGHT:** allows a manual adjustment of LCD brightness.
 - **CONTRAST:** allows a manual adjustment of LCD contrast.
- **NETWORK:** displays network information about the device.
 - **IP:** IP address.
 - **MASK:** subnet mask.
 - **GATE:** gateway.
- **DEFAULT:** restores the factory settings. Deletes all information stored on the device (configuration, network addresses, etc.).
- **INFO:** displays the firmware version of the device.



Main menu

7.5 Player menu

Pressing the PLAYER (A or B) key displays detailed information about current playback. If you then press the MENU key, you access the PLAYER MENU. It consists of the following sub-menus:

- **LOAD PLAYLIST:** to load one of the 99 playlists (preset with EclerNet Manager). By default, playlists 01 and 02 respectively correspond to USB port and SD slot, but can be reconfigured with EclerNet Manager software.
- **VOLUME:** manual adjustment of the player volume setting.
- **VARISPEED:** manual adjustment of the current playback speed. This option is not available for streaming.
- **PLAYMODE:** playback mode.
 - **SEQUENTIAL:** sequential playback (same alphanumeric order as the storage device).
 - **RANDOM:** random playback.
- **REPEAT MODE:** repeat mode.
 - **PLAY ALL:** plays (without repeating) all items (tracks or playlists) within a playlist.
 - **PLAY ONE:** plays (without repeating) the selected item.
 - **REPEAT ALL:** repeats all the items within a playlist in loop mode. At the end of the last item, playback restarts from the first, etc.
 - **REPEAT ONE:** repeats the selected item.
- **FADE MODE:** transition mode between audio tracks inside the playlist.
 - **NO FADE:** transition without fades. Once a track ends, the next track in the playlist starts playing.
 - **CROSSFADE:** the transition between tracks progressively reduces the volume level of the ending track as the next track volume level gradually increases, merging both tracks for a short time until the starting track reaches its nominal volume level.
 - **FADE:** the outgoing track fades out. After this, the next track fades in until it reaches its nominal volume level. There's no crossfade between tracks.
 - **HALF-FADE:** the transition between tracks progressively reduces the volume of the ending track as the next track starts playing at its nominal volume level before the outgoing track reaches its minimum value.



Player menu

8 REMOTE CONTROL

The DUO-NET PLAYER includes an IR (infrared) remote control to facilitate user management. This remote control is divided into 2 sections: PLAYER A and PLAYER B, both being identical, except that they control their respective player.

- **ON/STBY:** turns off the display. All LEDs and keys also turn off except the selected PLAYER (A or B). Pressing it again turns on the display and the LEDs.
- **F1-F5 keys:** programmable through EclerNet software. See the EclerNet Manager Application manual at www.ecler.com for more information.
- **SRC:** repeatedly pressing it cycles through the first five playlist memories (1, 2, 3, 4, 5, 1, 2, 3, 4, 5, 1, etc.) of the DUO-NET unit to select the playback source.
- **INFO:** to navigate through the different information screens about the player (A or B).
- **VARISPEED:** changes the tempo of the playing track (S + to increase the tempo,> S < to restore the original tempo and S- to decrease the tempo).
- **Transport keys (PLAY/PAUSE/STOP/REW/FF):** similar to the front panel keys.
- **VOLUME:** increases or decreases the player volume level.
- **MUTE key:** mutes the player.



9 CLEANING

The front panel should not be cleaned with dissolvent or abrasive substances because silk-printing could be damaged. To clean it, use a soft cloth slightly wet with water and neutral liquid soap; dry it with a clean cloth. Be careful that water never gets into the unit through the holes of the front panel.

10 DIAGRAMS and FUNCTION LIST

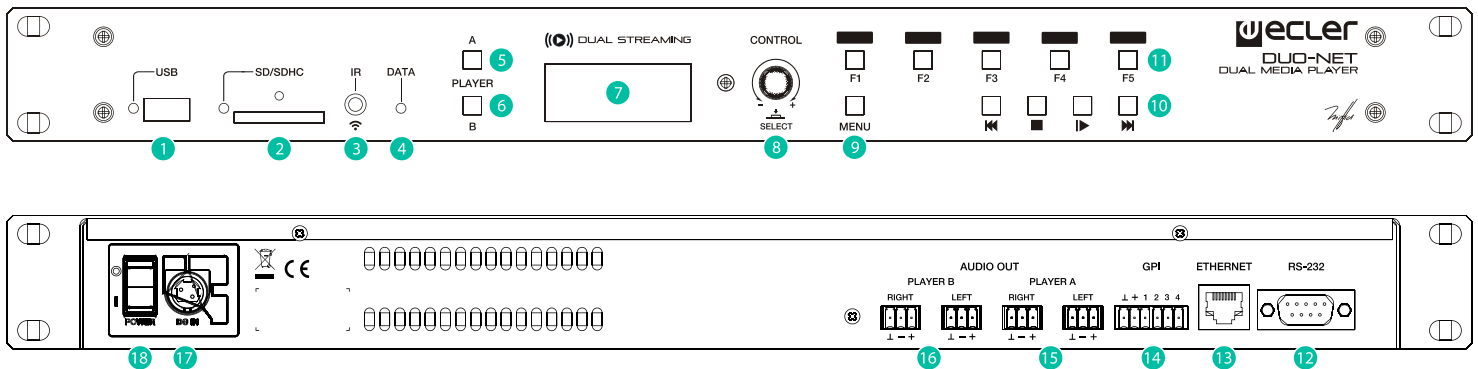

- | | |
|--|--|
| <p>1 USB port with LED indicator showing data activity</p> <p>2 SD/SDHC card slot with LED indicator showing data activity</p> <p>3 IR receiver</p> <p>4 DATA LED indicating network traffic</p> <p>5 PLAYER A key</p> <p>6 PLAYER B key</p> <p>7 LCD display</p> <p>8 CONTROL digital encoder</p> <p>9 MENU key</p> <p>10 Transport bar (PREV/RW, STOP, PLAY/PAUSE and NEXT/FF)</p> <p>11 Programmable function keys (F1-F5)</p> | <p>12 Remote control, RS-232 port</p> <p>13 RJ45 connector, Ethernet</p> <p>14 GPI ports</p> <p>15 PLAYER A balanced stereo output</p> <p>16 PLAYER B balanced stereo output</p> <p>17 External PSU connector</p> <p>18 Mains switch, POWER</p> |
|--|--|

11 BLOCK DIAGRAM

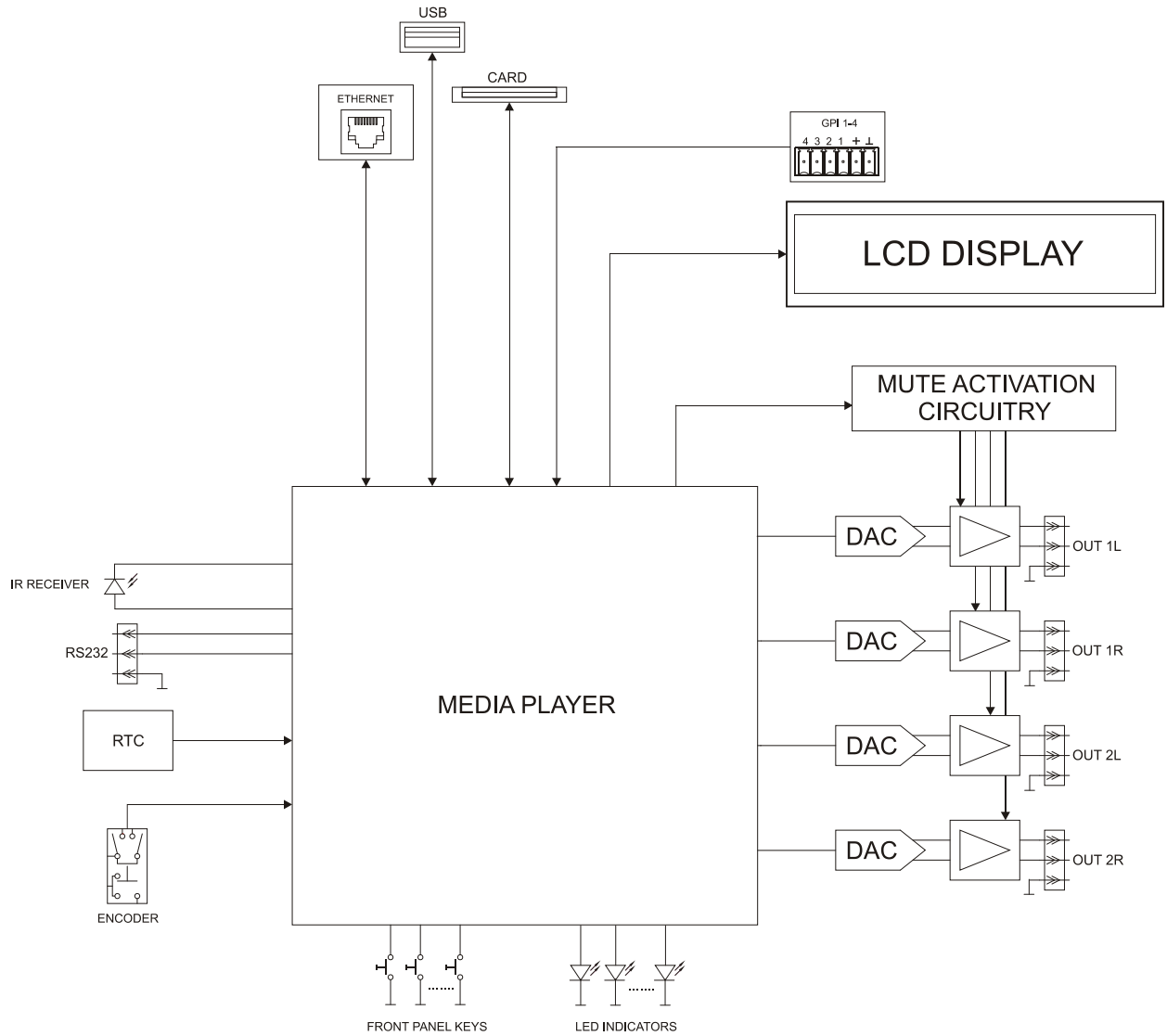

12 TECHNICAL CHARACTERISTICS

DUO-NET PLAYER

ETHERNET	
Connector	RJ45
Speed	10/100Mbps
AUDIO OUTPUT	
Nominal output level	+6dB (balanced) 0db (unbalanced)
Max Output Level/Minimum Load	+12dBV / 5k Ω
Freq. Response	5Hz - 24kHz (-3dB)
Balanced output header	4 x 3 pin terminal block
Output impedance	300 Ω
MEDIA PLAYER	
Audio DAC	24bit / 48kHz
Output Noise Floor (FFT)	-100dB (from 20Hz to 20kHz)
THD + Noise	< 0.005% (1kHz, 1Vrms)
Compatible file formats	mp3, ogg, WAV, AAC, FLAC, OPUS
SOURCES	
Network locations (Samba protocol)	
USB content	
SD content	
Internet Radio Streams	
GPI	
Number/input voltage	4 ports / 0 - 10VDC
Output header	6 pin Terminal block
RS-232	
SubD female connector 9 pin	TP-net protocol
RTC	
Time and date retention (battery)	84 hours aprox.
RTC accuracy	\pm 1 min. / month
PANEL	
MATRIX DISPLAY	160x64 pixels
Led indicator	USB, SD, NETWORK, PLAYER A/B, F1-F5, PLAY/PAUSE
Direct buttons	ENCODER, F1-F5, MENU, PREV, NEXT, PLAY, STOP, PLAYER A/B
SUPPLY	
DC supply	\pm 17,5 VDC
Mains	100-240VAC + External PSU 17,5VDC
Power consumption	15VA
MECHANICAL	
Dimensions WxHxD	482.6x44x120mm
Weight	1800gr

 USB and SD card interfaces

USB host interface	USB 2.0 High Speed (480 Mbps) Supports mass storage class devices (externally powered above 500mA current draw) Up to 2TB
Micro SD card interface	Supports SD ver1.0, SDHC Up to 32GB Supports FAT16, FAT 32 and VFAT
FAT and files analysis	Multi-partition up to 1 65354 playable folders 65354 playable folders within each folder 65354 playable files within each folder
Folder hierarchy	Up to 8 containing the root directory
Playable extensions	mp3, wav, ogg, aac, flac
Sorting in alphabetical order	UNICODE Up to 100 folders Up to 100 files by folder (Folders/files over 100 sorted in the FAT order)

 ACCESSORIES SUPPLIED

Main power cable, IR remote control unit	
Remote control battery	2 x AAA, LR-03 1,5V

TP-NET PROTOCOL

SOFTWARE

Third-Party NET

USER MANUAL

13 TP-NET PROTOCOL INTRODUCTION

The TP-NET protocol lets a client device (control device) get and/or set the values of several parameters of the **EclerNet compatible devices** (MIMO and MIMO SG series digital matrices, **DUO-NET PLAYER**, NXA digital audio manager series, NZA amplifier series, NPA amplifier series, etc.), like volumes, mutes, alarms, etc. It's as well available for eMIMO1616 digital matrix, HUB series digital zoner, MIMO7272DN and MIMO4040CDN digital matrix.

The communication with these digital audio devices can be established using Ethernet and the UDP/IP transport protocol, always by means of the **5800** UDP port.

A second option for this communication is using the RS-232 interface that some of these compatible devices do also have (MIMO series, DUO-NET PLAYER, NXA series, etc.). In this case, the serial connection must fulfil the following specifications:

- Baud rate: **57600** (fixed, no autonegotiation) for all the devices, except for DUO-NET PLAYER, eMIMO1616, HUB series and MIMO4040CDN, which use **115200** baud rate)
- Data bits: 8
- Parity: None
- Stop bits: 1
- Flow control: None

In case the Ecler device has an Euroblock connector for the RS-232 interface, the serial cable wiring, from the device's connector to a standard DB9 serial interface connector, must be the following:

WIRING RS232 – DB9	
RS232	DB9
Tx	Pin 2 (RxD)
Rx	Pin 3 (TxD)
Gnd	Pin 5 (Signal Gnd)

The protocol is simple and direct, making it easy to read, write and modify the generated code. It is based on messages with no begin and end delimiter: each message is self-delimited by the UDP packet size, which is defined with a maximum of **80 characters**. All the messages must be written in capital letters.

To let some control systems (like CRESTRON®, EXTRON®, AMX®, RTI®, VITY®, MEDIALON®, etc.) process the messages more easily, the EclerNet device adds the character **LF (0x0A)** to the end of each message. This way the client can buffer the messages to process them, if it's required. The EclerNet device can also handle several messages received in a single message packet by using the **LF** delimiter.

The available messages are built with one or more fields separated with blank spaces (= blank space):

<TYPE> [PARAM1] [PARAM2] [PARAM3] [PARAM4][LF]

The first field (**TYPE**) defines the **message type** and then, the required parameters for it (each kind of message requires a given number of parameters). The field **TYPE** can have these values:

- **SYSTEM**
- **GET**
- **SET**
- **INC**
- **DEC**
- **SUBSCRIBE**
- **UNSUBSCRIBE**
- **DATA**
- **ERROR**

At the end of this document you'll find all the available messages and their parameters for each model of the EclerNet compatible devices.

The **SYSTEM, GET, SET, INC, DEC, SUBSCRIBE & UNSUBSCRIBE** messages can be sent from the client to the EclerNet device. The **DATA & ERROR** messages can be sent from the device to the client. The only exception is the **SYSTEM PING** message, that is a **SYSTEM** type message that is sent from the EclerNet device when the initial message from the client to the device was **SYSTEM CONNECT PINGPONG**.

The communication (using UDP or RS-232) starts when a client sends the message **SYSTEM CONNECT** to the EclerNet device. As far as the UDP communication requires no connection (unlike the TCP), the EclerNet device stores this client's IP address, and then uses it as the destination IP address for the messages that it generates (**DATA & ERROR**). After receiving the **SYSTEM CONNECT** message, the device dumps its entire configuration using several consecutive **DATA** messages.

The communication can be terminated by two methods:

- **Manually:** when the client sends the **SYSTEM DISCONNECT** message, cancelling all the subscriptions and stopping the **DATA** & **ERROR** messages
- **Automatically:** in case the initial message was **SYSTEM CONNECT PINGPONG** and the client didn't get any **SYSTEM PONG** message in a period longer than 10 seconds (presuming a communication breakdown)

The **SET** messages don't have an automatic acknowledgement with a **DATA** message sent from the EclerNet device after it has processed the **SET** command. The client must update the values itself and must send the needed **GET** message if it requires confirmation from the device.

NOTES:

- The numerical values are always integer numbers without +, -, comma or dot symbols.
- **[PINGPONG]** is an optional parameter used to configure the device-client communication with a periodical check, to see whether the client or the device have terminated it. When configured this way, the device sends a **SYSTEM PING** once per second, and the client must answer with a **SYSTEM PONG** message. If anyone doesn't get these messages along a 10 seconds period, the communication will be considered terminated
- **<Input Channel>** & **<Output Channel>** are numerical values that identify an input or output channel of the EclerNet device.
- **<Preset Number>** is a numerical value that identifies one available Preset stored in the EclerNet device's memory:

For the DUO-NET PLAYER it can be within the [1..20] range.

- **<Level>**, **<Pre Vumeter Level>** y **<Post Vumeter Level>** are numerical values in the [0..100] range that define values in a scale equivalent to [-inf..0] dB
- **<GPI>** & **<GPO>** are numerical values within the [1..8] range.
- **<GPI Value>** is a numerical value within the [0..100] range that indicates the value of an analogue GPI input. For a digital input only 0 or 100 are the possible values
- **<GPO Value>** is a numerical value within the [0..1] range: it can only be 0 or 1 (opened or closed GPO).
- **<Rate>** is a numerical value within the [1..10] range that sets the VU-meter refresh rate, or the number of times the vumeters' values are sent per second (by default = 3).
- **"<Device Name>"** is the device name inside double quotation marks, to allow for names with blank spaces.
- **<Error ID>** is a numerical value for an error code.
- **"<Error Description>"** is a text chain inside double quotation marks, containing an error description
- **<Virtual Control>** is a numerical value that identifies a Virtual Control.

14 DUO-NET PLAYER AUDIO PLAYER & STREAMING RECEIVER

IMPORTANT NOTE: The communication must be started with the client sending **the first message SYSTEM CONNECT** to the EclerNet device. Otherwise, the commands from the client to the EclerNet device will be ignored. See [TP-NET PROTOCOL INTRODUCTION chapter](#) for additional information.

TYPE	PARAM1	PARAM2	PARAM3	PARAM4	DESCRIPTION
SYSTEM	CONNECT	[PINGPONG]			Saves the client IP address for responses and then dumps current device status (with DATA messages)
	DISCONNECT				Cancel subscriptions and terminates communication
	SUBSCRIPTION_RATE	<Rate>			Alive message from device
	PING				Alive message from device
	PONG				Alive ACK message from client
	PING_INTERVAL				
GET	ALL				Dumps current device status (with DATA messages)
	PRESET_INDEX				Gets the current PRESET number
	PRESET_NAME				Gets the current PRESET name
	DEVICE_NAME				Gets the Device Name
	INFO_MODEL				Gets the Device Model
	INFO_VERSION				Gets the Firmware Version
	INFO_MAC				Gets the Device MAC address
	INFO_IPLIST				Gets the IP parameters of the connected client devices
	IP_CONFIG				Shows the DUO-NET unit's current IP configuration
PLAYER_NAME	<PLAYER:A/B>			Gets the PLAYER A or B NAME	

PLAYER_MUTE	<PLAYER:A/B>			Gets the MUTE status of PLAYER A or B
PLAYER_VOLUME	<PLAYER:A/B>			Gets the VOLUME level of PLAYER A or B
PLAYER_VUMETER	<PLAYER:A/B>			Gets the VUMETER level of PLAYER A or B
PLAYER_TIME	<PLAYER:A/B>			Gets PLAYER A or B elapsed, remaining and total time of the current media playback
PLAYER_TRANSPORT_STATUS	<PLAYER:A/B>			Gets PLAYER A or B current playback status
PLAYER_PLAYLIST_INDEX				Gets PLAYER A or B loaded playlist number, from the 99 available in the playlist bank
PLAYER_PLAYLIST_NAME	<PLAYER:A/B>			Gets PLAYER A or B loaded playlist name, from the 99 available in the playlist bank
PLAYER_QUEUE_INFO	<PLAYER:A/B>			Gets PLAYER A or B current playback queue position (index) and total number of items in it (count)
PLAYER_PLAY_MODE	<PLAYER:A/B>			Gets PLAYER A or B current playback order mode
PLAYER_REPEAT_MODE	<PLAYER:A/B>			Gets PLAYER A or B current playback repeat mode
PLAYER_FADE_MODE	<PLAYER:A/B>			Gets PLAYER A or B current tracks playback transition mode
PLAYER_VARISPEED	<PLAYER:A/B>			Gets PLAYER A or B current playback tempo variation value
PRIORITY_STATUS	<PRIORITY:1/2>			Gets PRIORITY MODULE 1 or 2 status
PLAYER_ITEM_TAGS	<PLAYER:A/B>			Gets PLAYER A or B current playback ALIAS, TITLE, ARTIST, ALBUM and NAME tags

SET	PRESET_INDEX	<1..20>			Sets the current PRESET number
	PLAYER_MUTE	<PLAYER:A/B>	<YES/NO>		Sets the MUTE status of PLAYER A or B
	PLAYER_VOLUME	<PLAYER:A/B>	<0..100>		Sets the VOLUME level of PLAYER A or B
	PLAYER_TRANSPORT_CONTROL	<PLAYER:A/B>	<STOP/PLAY/PAUSE/NEXT/PREV>		Sets PLAYER A or B transport controls
	PLAYER_PLAYLIST_INDEX	<PLAYER:A/B>	<1..99>		Sets (loads) PLAYER A or B playlist number, from the 99 available in the playlist bank
	PLAYER_PLAY_MODE	<PLAYER:A/B>	<SEQUENTIAL/RANDOM>		Sets PLAYER A or B playback order mode
	PLAYER_REPEAT_MODE	<PLAYER:A/B>	<PLAY_ALL/PLAY_ONE/REPEAT_ALL/REPEAT_ONE>		Sets PLAYER A or B current playback repeat mode
	PLAYER_FADE_MODE	<PLAYER:A/B>	<NONE/XFADE/FADE/HFADE>		Sets PLAYER A or B current tracks playback transition mode
	PLAYER_VARISPEED	<PLAYER:A/B>	<VARISPEED:-50..50>		Sets the current Varispeed (track's tempo) variation value, from -50% to +50%
INC	PLAYER_VOLUME	PLAYER:A/B>	<0..100>		INCREASES the current VOLUME of a PLAYER, a value from ± 1 to ± 100
	PLAYER_VARISPEED	PLAYER:A/B>	<VARISPEED:-50..50>		INCREMENTS the current Varispeed (track's tempo) variation value, from -50% to +50%
DEC	PLAYER_VOLUME	PLAYER:A/B>	<0..100>		DECREASES the current VOLUME of a PLAYER, a value from ± 1 to ± 100
	PLAYER_VARISPEED	PLAYER:A/B>	<VARISPEED:-50..50>		DECREMENTS the current Varispeed (track's tempo) variation value, from -50% to +50%
SUBSCRIBE	ALL				Subscribes to all VU-meters and player times
	PLAYER_VUMETER	PLAYER:A/B>			Subscribes to the VUMETER level of PLAYER A or B
	PLAYER_TIME	PLAYER:A/B>			Subscribes to the TIME values (elapsed, remaining, total) of PLAYER A or B
UNSUBSCRIBE	ALL				Unsubscribes to all VU-meters and player times

	PLAYER_VUMETER	PLAYER:A/B>			Unsubscribes to the VUMETER level of PLAYER A or B
	PLAYER_TIME	PLAYER:A/B>			Unsubscribes to the TIME values (elapsed, remaining, total) of PLAYER A or B

DATA	PRESET_INDEX	<1..20>			Shows the current PRESET number
	PRESET_NAME	"<NAME>"			Shows the current PRESET name
	DEVICE_NAME	"<NAME>"			Shows the Device Name
	INFO_MODEL	<Device Model>			Shows the Device Model
	INFO_VERSION	<Firmware Version>			Shows the Firmware Version
	INFO_MAC	<Device MAC address>			Shows the Device MAC address
	INFO_IPLIST	<N>	<IP>	<PORT>	Shows the IP parameters of the connected client devices, where N is an incremental number assigned to each one, followed by the IP:port it has Example with 2 clients : DATA INFO_IPLIST 1 192.168.1.2 55229 DATA INFO_IPLIST 2 192.168.1.2 55231

IP_CONFIG	IP>	<PORT>	<NETMASK>	<GATEWAY>	Shows the DUO-NET unit's current IP configuration. Example: <i>DATA IP_CONFIG</i> <i>192.168.0.6 5000</i> <i>255.255.0.0 192.168.0.1</i>
PLAYER_NAME	<PLAYER:A/B>	"<NAME>"			Shows the PLAYER A or B NAME
PLAYER_MUTE	<PLAYER:A/B>	<MUTE:YES/NO>			Shows the MUTE status of PLAYER A or B
PLAYER_VOLUME	<PLAYER:A/B>	<VOL:0..100>			Shows the VOLUME level of PLAYER A or B
PLAYER_VUMETER	<PLAYER:A/B>	<VOL:0..100>			Shows the VUMETER level of PLAYER A or B
PLAYER_TIME	<PLAYER:A/B>	<ELAPSED>	<REMAIN>	<TOTAL>	Shows PLAYER A or B elapsed, remaining and total time of the current media playback
PLAYER_TRANSPORT_STATUS	<PLAYER:A/B>	<STATUS:STOPPED/PLAYING/PAUSE>			Shows PLAYER A or B current playback status
PLAYER_PLAYLIST_INDEX	<PLAYER:A/B>	<INDEX:1..99>			Shows PLAYER A or B loaded playlist number, from the 99 available in the playlist bank
PLAYER_PLAYLIST_NAME	<PLAYER:A/B>	"<NAME>"			Shows PLAYER A or B loaded playlist name, from the 99 available in the playlist bank
PLAYER_QUEUE_INFO	<PLAYER:A/B>	<QUEUE_INDEX>	<QUEUE_COUNT>		Shows PLAYER A or B current playback queue position (index) and total number of items in it (count)

PLAYER_PLAY_MODE	<PLAYER:A/B>	<MODE:SEQUENTIAL/RANDOM>		Shows PLAYER A or B current playback order mode
PLAYER_REPEAT_MODE	<PLAYER:A/B>	<MODE:PLAY_ALL/PLAY_ONE/REPEAT_ALL/REPEAT_ONE>		Shows PLAYER A or B current playback repeat mode
PLAYER_FADE_MODE	<PLAYER:A/B>	<MODE:NONE/XFADE/FADE/HFADE>		Shows PLAYER A or B current tracks playback transition mode
PLAYER_VARISPEED	<PLAYER:A/B>	<VALUE:-50..50>		Shows PLAYER A or B current playback tempo variation value
PRIORITY_STATUS	<PRIORITY:1/2>	<STATUS:RUNNING/STOPPED>		Shows PRIORITY MODULE 1 or 2 status
PLAYER_ITEM_TAG_ALIAS	<PLAYER:A/B>	"<ALIAS>"		Shows PLAYER A or B current playlist ALIAS field
PLAYER_ITEM_TAG_TITLE	<PLAYER:A/B>	"<TITLE>"		Shows PLAYER A or B current playback title tag
PLAYER_ITEM_TAG_ARTIST	<PLAYER:A/B>	"<ARTIST>"		Shows PLAYER A or B current playback artist tag
PLAYER_ITEM_TAG_ALBUM	<PLAYER:A/B>	"<ALBUM>"		Shows PLAYER A or B current playback album tag
PLAYER_ITEM_TAG_NAME	<PLAYER:A/B>	"<NAME>"		Shows PLAYER A or B current playback name tag

15 ERROR CODES FOR ECLERNET DEVICES

15.1 COMMON ERROR CODES (to all EclerNet - TP-NET compatible devices)

ERROR ID	DESCRIPTION
0	TPNET_ERROR_NONE = 0,
1	TPNET_ERROR_INVALID_FIELD_TYPE,
2	TPNET_ERROR_INVALID_FIELD_PARAM1,
3	TPNET_ERROR_INVALID_FIELD_PARAM2,
4	TPNET_ERROR_INVALID_FIELD_PARAM3,
5	TPNET_ERROR_INVALID_FIELD_PARAM4,

15.2 DUO-NET PLAYER SPECIFIC ERROR CODES

ERROR ID	DESCRIPTION
6	TPNET_ERROR_INVALID_FIELD_PARAM5,
7	TPNET_ERROR_TIMEOUT_PONG,
8	TPNET_ERROR_CONNECT_WHILE_CONNECTED,
9	TPNET_ERROR_DISCONNECT_WHILE_UNCONNECTED,
10	TPNET_ERROR_INVALID_CLIENT_IP,
11	TPNET_ERROR_MESSAGE_TOO_LONG,
12	TPNET_ERROR_UNSUPPORTED_MESSAGE,
13	TPNET_ERROR_INVALID_RATE_VALUE,
14	TPNET_ERROR_MAX_CLIENTS_REACHED,
15	TPNET_ERROR_MASTER_MODE,

16 HOW TO IDENTIFY INTERNET RADIO URL STREAMS

This document shows how to identify internet radio streams in order to play them in audio streaming players such as Ecler ePLAYER1 or Ecler DUO-NET PLAYER. Few examples are given, but there are a lot of different options. Feel free to find your favourite internet radio websites!

IMPORTANT NOTE:

A valid audio stream looks like this:

http://www.my_favourite_radio.mp3

<http://111.111.11.1:8080>

<http://listen.radio/rock.m3u>

etc.

An address such as “http://www.my_radio.com” is not directly an audio streaming, but a generic website address. This website could include a real audio streaming service, which will have its own URL.

16.1 How to discover streaming URLs included in websites:

- **EXAMPLE 1:**

1. Open your favourite web browser.
2. Type (or search for) a live radio manager website. Listenlive.eu is used in this example.

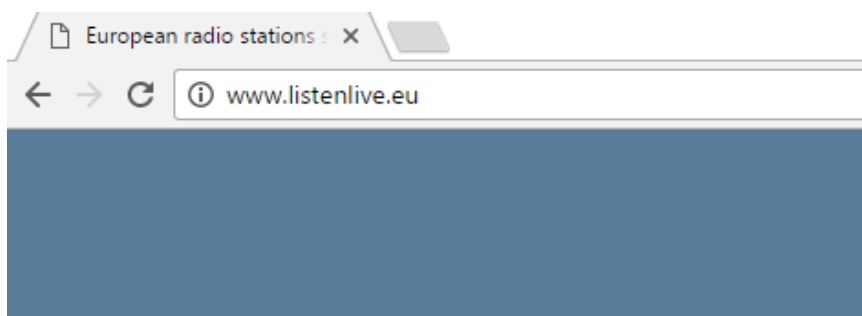

3. In this website, look for your radio and click on the bitrate. An “.m3u” will be downloaded.

listenlive.eu			
European radio stations streaming live on the internet			
Radio station	Location	Listen Live	Format/Comments
RNE Radio Nacional	Madrid	64 Kbps	News/information/features
RNE Radio Clásica	Madrid	128 Kbps	Classical/cultural programming
RNE Radio 3	Madrid	128 Kbps	News/music for young people
RNE Ràdio 4	Barcelona	64 Kbps	News/music/features (Catalan)

4. Open this “.m3u” with a text editor. You will see the audio streaming URL.

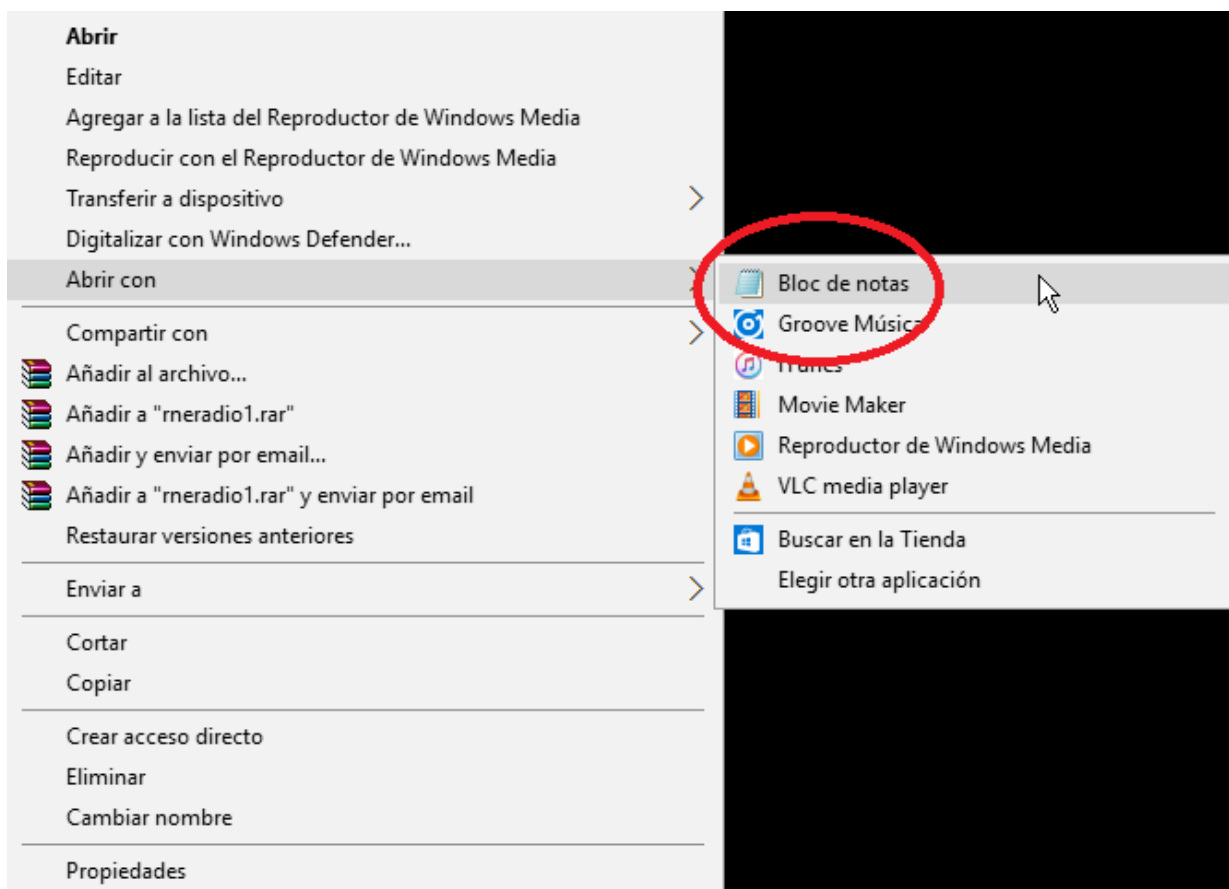

5. To check it, open a new tab in your web browser and copy & paste this URL. If it is valid, it will start to play.

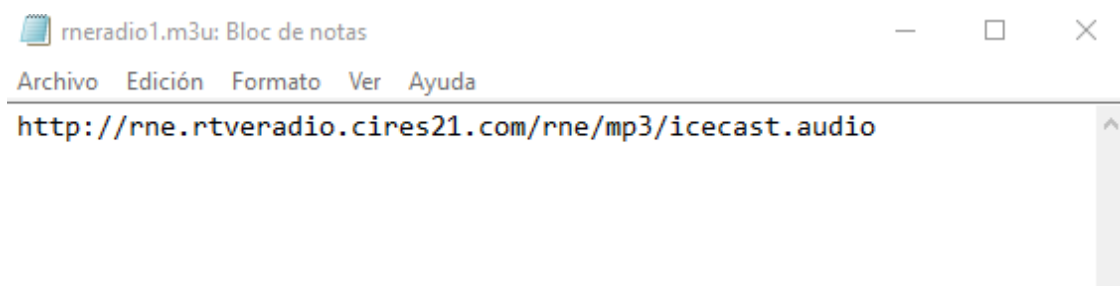

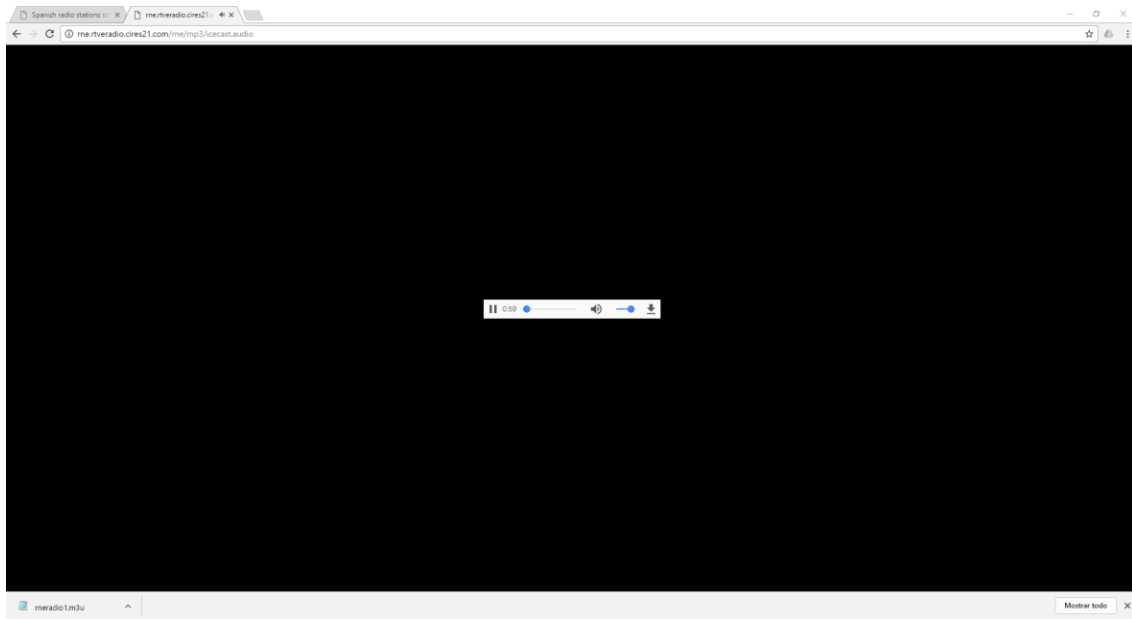

6. Finally, save this address in your audio streaming player (ePLAYER1/DUO-NET PLAYER).

PARAMETERS

Name	<input type="text" value="News"/>
Enabled Events	<input type="checkbox"/> GPI1 <input type="checkbox"/> GPI2 <input type="checkbox"/> SILENCE
Playlist	<input checked="" type="checkbox"/>
Path	<input type="text" value="http://me.rtveradio.cires21.com/m"/>
Media alias	<input type="text" value="RNE"/>

EXAMPLE 2:

1. Open your favourite web browser.
2. Type (or search for) a live radio manager website. Internet-radio.com is used in this example.

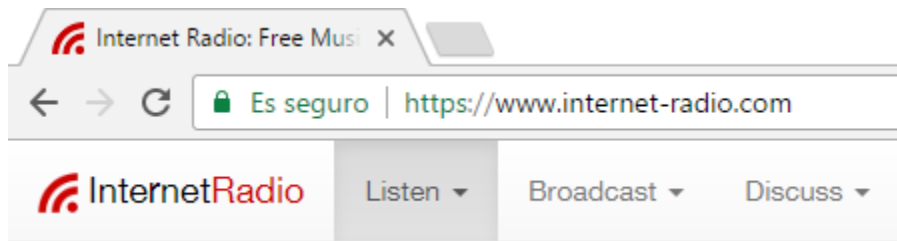

3. In this website, search your radio and click on “.m3u” or “.pls” link. An “.m3u” or “.pls” file will be downloaded.



4. Open this “.m3u” with a text editor. You will see the audio streaming URL.



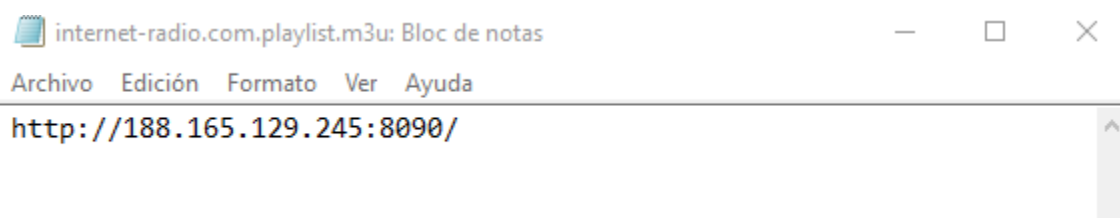
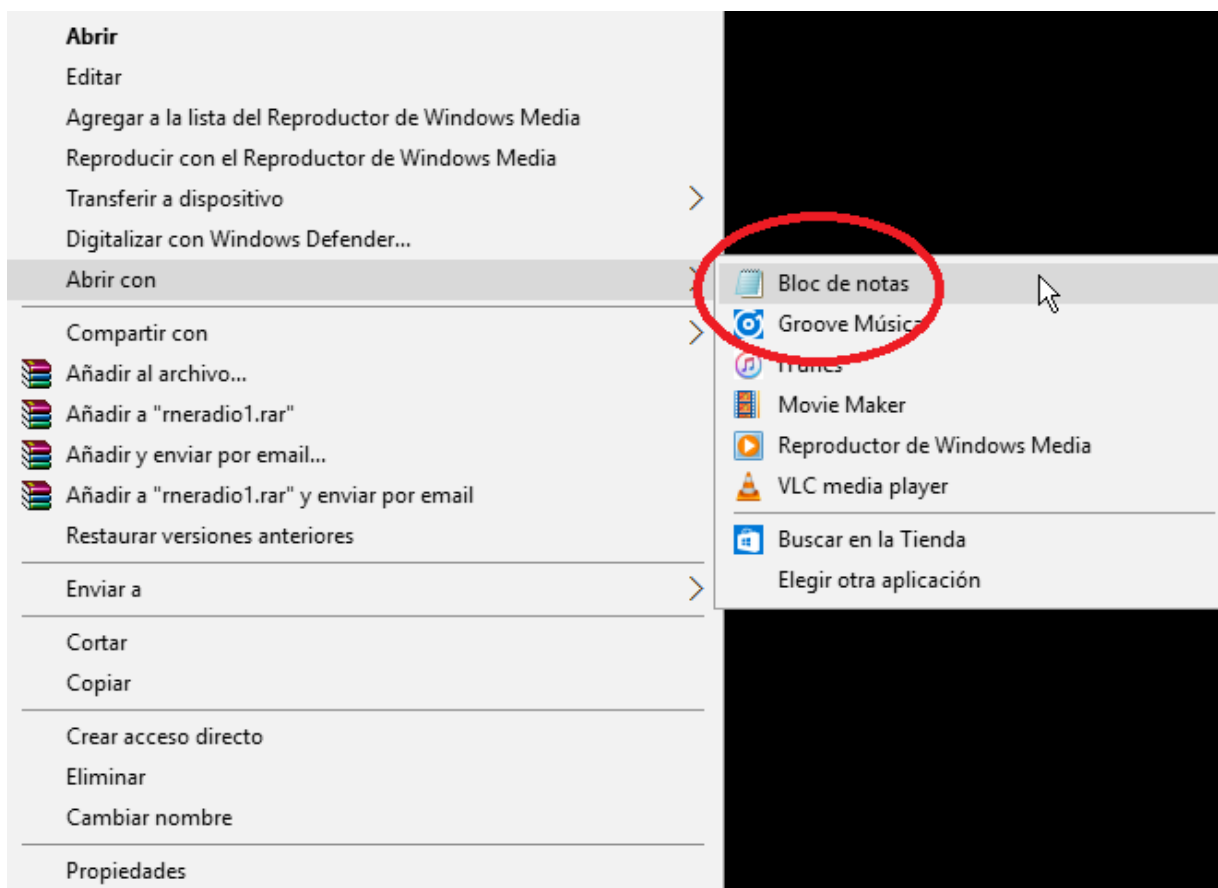

5. To check it, open a new tab in your web browser and copy & paste this URL. If it is valid, it will start to play.



6. Finally, save this address in your audio streaming player (ePLAYER1/DUO-NET PLAYER).

PARAMETERS

Name	<input type="text" value="News"/>
Enabled Events	<input type="checkbox"/> GPI1 <input type="checkbox"/> GPI2 <input type="checkbox"/> SILENCE
Playlist	<input checked="" type="checkbox"/>
Path	<input type="text" value="http://188.165.129.245:8090/"/>
Media alias	<input type="text" value="RAC1"/>

16.2 Playing internet radios via AirPlay (ePLAYER1):

ePLAYER1 must be in AirPlay Mode. Please, consult the user manual to know more about it.

1. Download and install iTunes. Once is installed in your PC, open it and click on Music/Edit Menu.

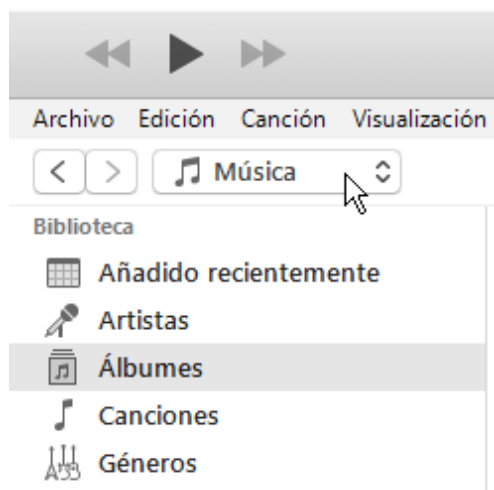

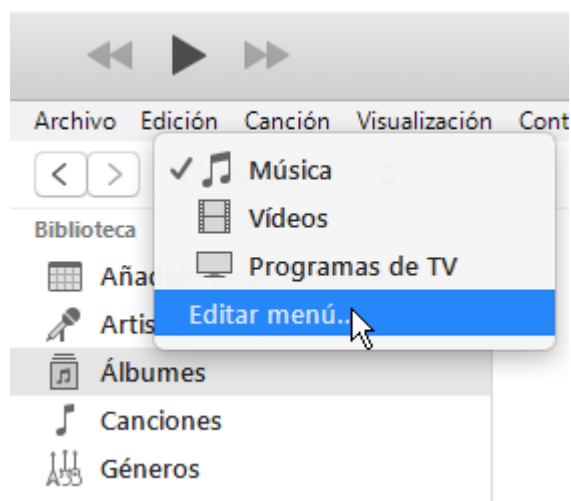

2. Check “Internet Radios”.

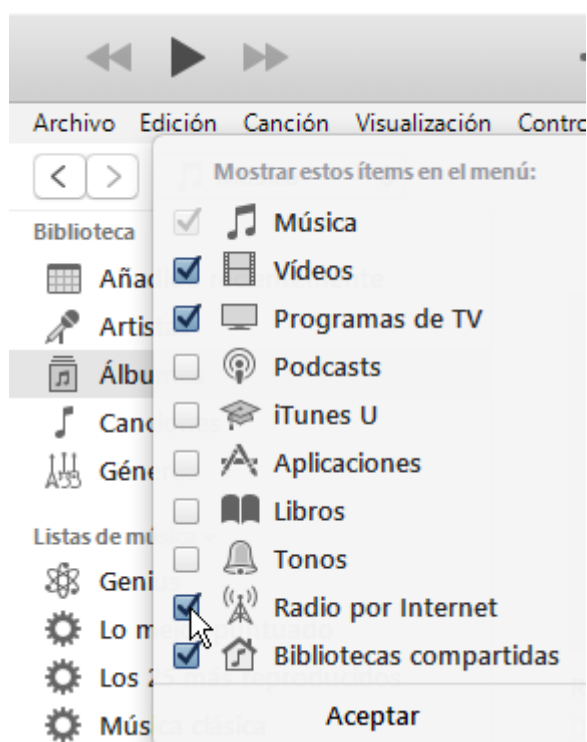

3. Now, select “Internet Radios”. You will see a wide catalogue of internet radio streamings.

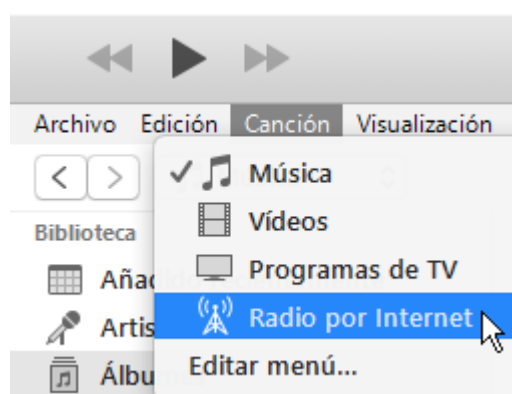

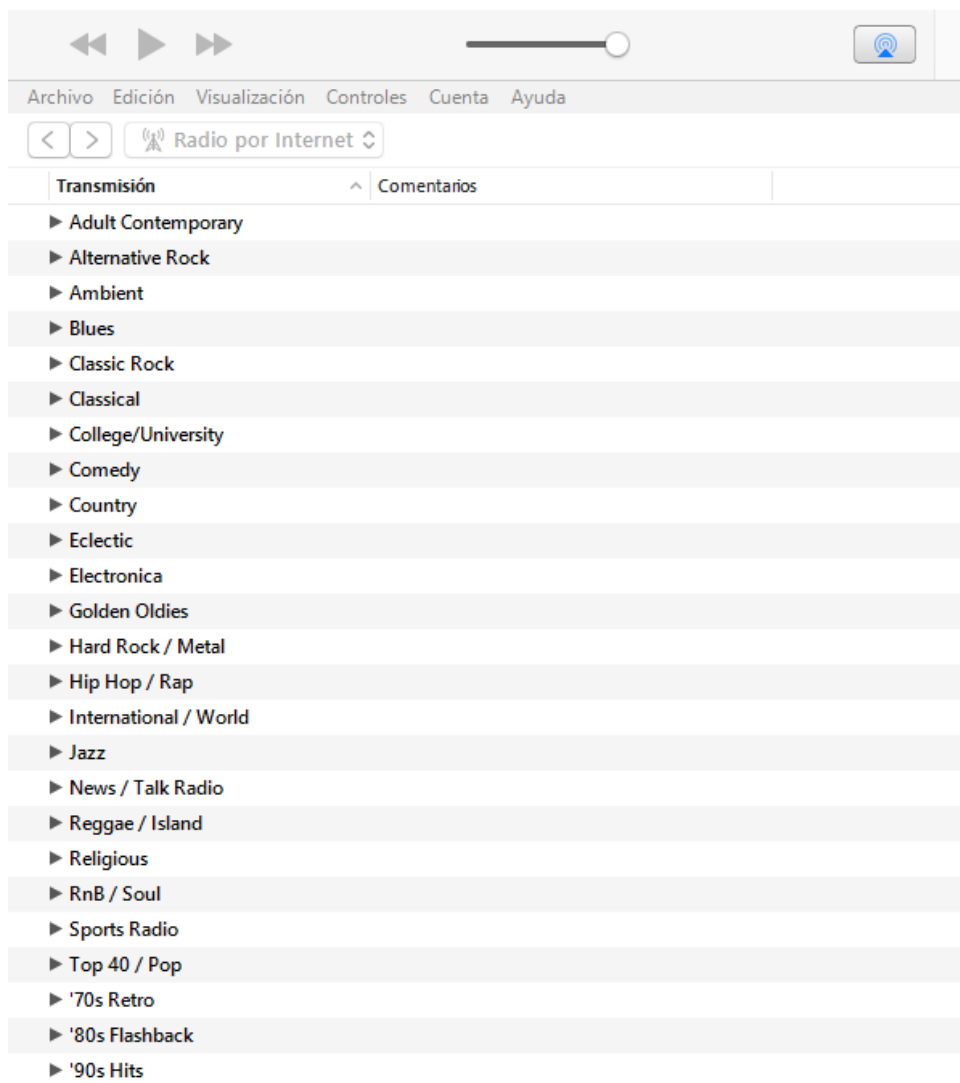

4. Select your favourite radio and click on it. Check on iTunes that ePLAYER1 is selected as the AirPlay device.

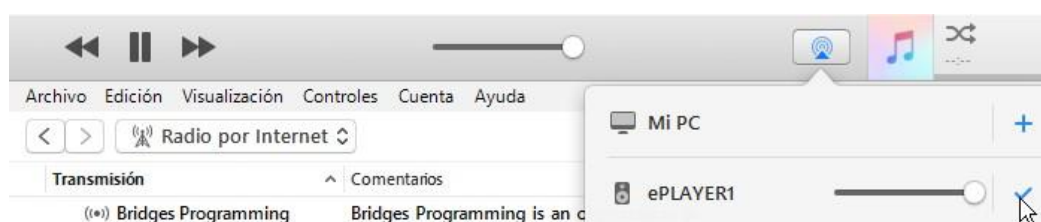

5. ePLAYER1 will start to play.

All product characteristics are subject to variation due to production tolerances. **NEEC AUDIO BARCELONA S.L.** reserves the right to make changes or improvements in the design or manufacturing that may affect these product specifications.

For technical queries contact your supplier, distributor or complete the contact form on our website, in [Support / Technical requests](#).

Motors, 166-168 08038 Barcelona - Spain - (+34) 932238403 | information@ecler.com | www.ecler.com