

# VEO-XTI1CG2 / VEO-XRI1CG2

VIDEO DISTRIBUTION OVER IP  
*H.265 Full HD over IP Video Extenders*



PRECAUTIONS

PACKAGE CONTENTS

DESCRIPTION & FEATURES

INSTALL & CONNECT

START-UP & OPERATION

PANEL FUNCTIONS

TECHNICAL DATA

## USER MANUAL

# TABLE OF CONTENTS

<b>1. PRECAUTIONS</b> .....	<b>3</b>
1.1 Important Remark.....	3
1.2 Important Safety Instructions .....	4
1.3 Cleaning.....	4
<b>2. PACKAGE CONTENTS</b> .....	<b>5</b>
2.1 VEO-XTI1CG2 .....	5
2.2 VEO-XRI1CG2.....	5
<b>3. DESCRIPTION and FEATURES</b> .....	<b>6</b>
3.1 Main Features .....	6
<b>4. INSTALL &amp; CONNECT</b> .....	<b>7</b>
4.1 Rack Mounting in VEO-RK1CG2.....	7
4.2 Network requirements and configuration.....	8
4.2.1 Setting the IP address.....	8
4.2.2 Video distribution Quick Start .....	9
4.2.3 Unicast mode .....	9
4.2.4 Multicast mode .....	10
<b>5. START-UP and OPERATION</b> .....	<b>11</b>
5.1 Configuration using Web Interface.....	11
5.1.1 Information .....	11
5.1.2 Video Settings .....	12
5.1.3 Led.....	16
5.1.4 Settings.....	17
5.1.5 Update.....	19
5.1.6 Log Out.....	20
5.2 Remote Controlling .....	20
5.2.1 RS-232.....	20
5.2.2 Advanced Network Management .....	23
<b>6. PANEL FUNCTIONS</b> .....	<b>24</b>
6.1 VEO-XTI1CG2 (TX, transmitter) .....	24
6.1.1 Front Panel.....	24
6.1.2 Rear Panel.....	25
6.2 VEO-XRI1CG2 (RX, receiver).....	26
6.2.1 Front Panel.....	26
6.2.2 Rear Panel.....	27
6.3 Additional Functionalities of CH Select ▲/▼ buttons for both: VEO-XTI1CG2 and VEO-XRI1CG2.....	28
<b>7. TECHNICAL DATA</b> .....	<b>31</b>
7.1 Technical Specifications .....	31
7.2 Mechanical Diagram .....	33
7.2.1 VEO-XTI1CG2 .....	33
7.2.2 VEO-XRI1CG2.....	33

PRECAUTIONS
PACKAGE CONTENTS
DESCRIPTION & FEATURES
INSTALL & CONNECT
START-UP & OPERATION
PANEL FUNCTIONS
TECHNICAL DATA

## 1. PRECAUTIONS

### 1.1 IMPORTANT REMARK



**WARNING: SHOCK HAZARD - DO NOT OPEN**

**AVIS: RISQUE DE CHOC ÉLECTRIQUE - NE PAS OUVRIR**



The lightning flash with arrowhead symbol, within an equilateral triangle, is intended to alert the user to the presence of uninsulated “dangerous voltage” within the product’s enclosure that may be of sufficient magnitude to constitute a risk of electric shock to persons.



The exclamation point within an equilateral triangle is intended to alert the user to the presence of important operating and maintenance (servicing) instructions in the literature accompanying the appliance.

**WARNING (If applicable):** The terminals marked with symbol of “⚡” may be of sufficient magnitude to constitute a risk of electric shock. The external wiring connected to the terminals requires installation by an instructed person or the use of ready-made leads or cords.

**WARNING:** To prevent fire or shock hazard, do not expose this equipment to rain or moisture.

**WARNING:** A device with Class I construction shall be connected to a mains socket-outlet with a protective earthing connection.



**WARNING:** This product must not be discarded, under any circumstance, as unsorted urban waste. Take to the nearest electrical and electronic waste treatment centre.



**This equipment has been tested and found to comply with the limits for a Class A digital device, pursuant to part 15 of the FCC Rules.** These limits are designed to provide reasonable protection against harmful interference when the equipment is operated in a commercial environment. This equipment generates, uses, and can radiate radio frequency energy and, if not installed and used in accordance with the instruction manual, may cause harmful interference to radio communications. Operation of this equipment in a residential area is likely to cause harmful interference in which case the user will be required to correct the interference at his own expense.



PRECAUTIONS

PACKAGE CONTENTS

DESCRIPTION & FEATURES

INSTALL & CONNECT

START-UP & OPERATION

PANEL FUNCTIONS

TECHNICAL DATA

## 1.2 IMPORTANT SAFETY INSTRUCTIONS

1. Read these instructions.
2. Keep these instructions.
3. Heed all warnings.
4. Follow all instructions.
5. Do not use this device near water.
6. Clean only with dry cloth.
7. Do not block any ventilation openings. Install in accordance with the manufacturer's instructions.
8. Do not install near any heat sources such as radiators, heat registers, stoves, or other device (including amplifiers) that produce heat.
9. Do not defeat the safety purpose of the polarized or grounding type plug. A polarized plug has two blades with one wider than the other. A grounding type plug has two blades and a third grounding prong. The wide blade or the third prong are provided for your safety. If the provided plug does not fit into your outlet, consult an electrician for replacement of the obsolete outlet.
10. Protect the power cord from being walked on or pinched particularly at the plugs, convenience receptacles, and at the point where they exit from the device.
11. Only use attachments/accessories specified by the manufacturer.
12. Unplug the device during lightening sorts or when unused for long periods of time.
13. Refer all servicing to qualified personnel. Servicing is required when the device has been damaged in any way, such as power supply cord or plug is damaged, liquid has been spilled or objects have fallen into the device, the device has been exposed to rain or moisture, does not operate normally, or has been dropped.
14. Disconnecting from mains: When switching off the POWER switch, all the functions and light indicators of the unit will be stopped, but fully disconnecting the device from mains is done by unplugging the power cable from the mains input socket. For this reason, it always shall remain easily accessible.
15. Equipment is connected to a socket-outlet with earthing connection by means of a power cord.
16. The marking information is located at the bottom of the unit.
17. The device shall not be exposed to dripping or splashing and that no objects filled with liquids, such as vases, shall be placed on device.

## 1.3 CLEANING



**Clean the unit with a soft, dry clean cloth or slightly wet with water and neutral liquid soap only, then dry it with a clean cloth. Be careful that water never gets into the unit through any hole. Never use alcohol, benzene, solvents or abrasive substances to clean this unit.**

**NEEC AUDIO BARCELONA, S.L.** accepts no liability for any damage that may be caused to people, animal, or objects due to failure to comply with the warnings above.



PRECAUTIONS

PACKAGE CONTENTS

DESCRIPTION & FEATURES

INSTALL & CONNECT

START-UP & OPERATION

PANEL FUNCTIONS

TECHNICAL DATA

**Thank you for choosing our device Ecler  
VEO-XTI1CG2 and VEO-XRI1CG2!  
We appreciate your trust.**

It is **VERY IMPORTANT** to carefully read this manual and to fully understand its contents before any connection in order to maximize your use and get the best performance from this equipment.

To ensure optimal operation of this device, we strongly recommend that its maintenance be carried out by our authorised Technical Services.

**All ECLER products are covered by warranty**, please refer to [www.ecler.com](http://www.ecler.com) or the warranty card included with this product for the period of validity and conditions.

## 2. PACKAGE CONTENTS

### 2.1 VEO-XTI1CG2

- 1 x Transmitter.
- 2 x 3-pin Euroblock connectors.
- 4 x Screws.
- 2 x Detachable mounting ear.
- 1 x 12V DC power adapter with international blades.
- Getting Started Guide.
- Warranty card.

### 2.2 VEO-XRI1CG2

- 1 x Receiver.
- 2 x 3-pin Euroblock connectors.
- 4 x Screws.
- 2 x Detachable mounting ear.
- 1 x 12V DC power adapter with international blades.
- Getting Started Guide.
- Warranty card.



PRECAUTIONS

PACKAGE CONTENTS

DESCRIPTION & FEATURES

INSTALL & CONNECT

START-UP & OPERATION

PANEL FUNCTIONS

TECHNICAL DATA

### 3. DESCRIPTION and FEATURES

**VEO-XTI1CG2 transmitter and VEO-XRI1CG2 receiver** are a H.265 / H.264 over IP set of extenders that allow for HDMI distribution over 1Gb Ethernet networks with up to 1080p@60Hz video support. These devices represent a professional high-quality compression and low bandwidth solution aimed for point-to-point, as well as multipoint-to-multipoint scenarios over a single 100m Cat5e/6/7 cable. VEO-XTI1CG2 and VEO-XRI1CG2 are widely suitable for various applications which also require PoE, audio management, video wall compositing or remote control, such as educational, commercial, or corporate installations, where flexible and scalable AV systems are in need. Furthermore, this transmitter and receiver can be paired with VEO-XCTRLG2 control module for an expanded management experience with in-built WEB configuration interface.

#### 3.1 MAIN FEATURES

- HDMI with video resolution up to 1920x1200p@60Hz 4:4:4.
- Signal transmission distance up to 100m over Cat5e/6/7 cable.
- Support for unicast over 1Gb unmanaged networks and multicast signal extension over 1Gb managed networks.
- Support for video wall compositing up to 9 x 9 setups.
- Support for audio embedding and extraction.
- Support for mainstream and sub stream encoding modes.
- Support for pass through and RS-232, TCP/IP, Web GUI management using VEO-XCTRLG2 controller module.
- HDCP 1.4 compliant.
- Support for PoE function.
- Local 12V DC power supply.



PRECAUTIONS
PACKAGE CONTENTS
DESCRIPTION & FEATURES
INSTALL & CONNECT
START-UP & OPERATION
PANEL FUNCTIONS
TECHNICAL DATA

## 4. INSTALL & CONNECT

### 4.1 RACK MOUNTING IN VEO-RK1CG2

This product can be mounted in a VEO-RK1CG2 3U rack accessory (Please contact your supplier for rack sale). The mounting steps are as follows:

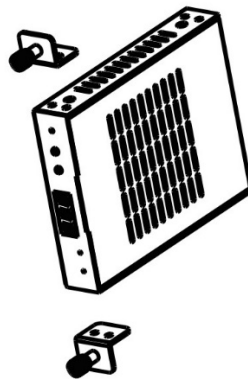
1. Use included screws to fix two mounting ears on the product, as shown in the figure below:



2. Insert the product with mounting ears into a 3U rack (up to 12 units can be installed vertically), as shown in the figure below:

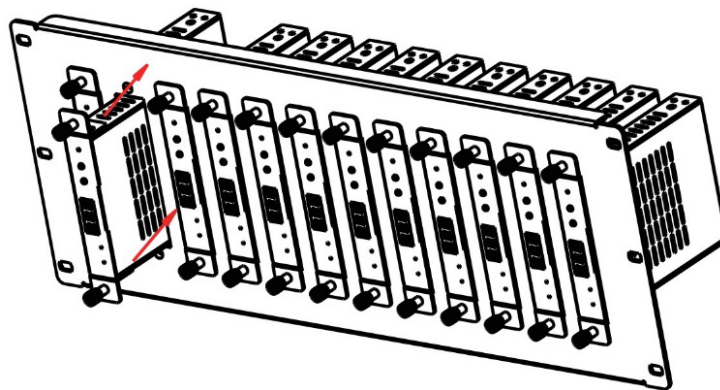

3. Use screws to fix mounting ears on the rack to complete the mounting, as shown in the figure below:

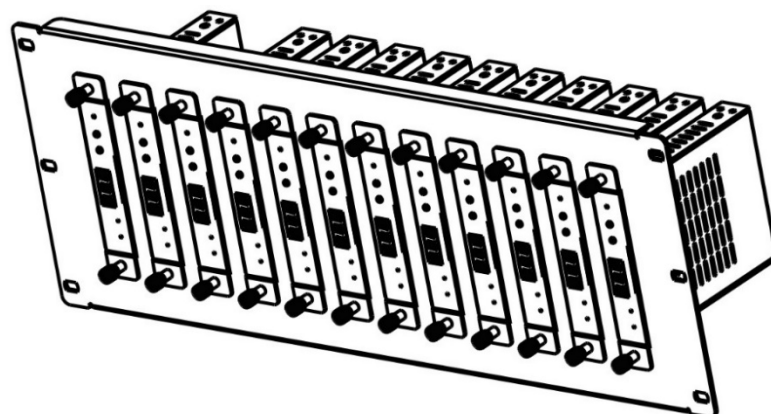

PRECAUTIONS

PACKAGE CONTENTS

DESCRIPTION & FEATURES

INSTALL & CONNECT

START-UP & OPERATION

PANEL FUNCTIONS

TECHNICAL DATA

## 4.2 NETWORK REQUIREMENTS AND CONFIGURATION

VEO-XTI1CG2 and VEO-XRI1CG2 are not limited to certain brands of network hardware, but the **network must support the following network features:**

- Layer 3 managed network switch.
- IGMP snooping support.

 To **prevent malfunctioning, interference or drop in signal performance** due to other network products bandwidth requirements or network design. It is highly recommended to **check with the chosen network IT staff how to properly set the Multicast products connected to the local network switch.**

### 4.2.1 SETTING THE IP ADDRESS

The default IP address is “auto IP” in the range 169.254.10.x for the transmitters and 169.254.20.x for the receivers. It can also be dynamically assigned by the VEO-XCTRLG2 controller in case it is present in the network. For further details please refer to [VEO-XCTRLG2 controller module user manual](#).

- 
- It's possible to **check the assigned IP address** from a transmitter or receiver **pressing and holding the ▲ (UP button) on the front panel**. For further details, refer to [Additional functionalities of CH select ▲/▼ buttons for both: VEO-XTI1CG2 & VEO-XRI1CG2](#) chapter.
  - **The IP address can be changed using the embedded web page of a transmitter or a receiver.** Both the network configuration of PC and VEO devices must be in the same network domain in order to be able to access its web settings page through an internet browser. For further details, refer to [Configuration using Web interface](#) chapter.

 **When static IP addresses are required, the IP address of each device needs to be set manually.**



PRECAUTIONS

PACKAGE CONTENTS

DESCRIPTION & FEATURES

INSTALL & CONNECT

START-UP & OPERATION

PANEL FUNCTIONS

TECHNICAL DATA



## 4.2.2 VIDEO DISTRIBUTION QUICK START

To begin a video transmission, a matching between a transmitter and a receiver is required. Each VEO-XTI1CG2 transmitter can stream a video signal over the network using an ID channel number that must be unique in the same network. Each ID channel from 0 to 762 identifies a IP address and every VEO-XRI1CG2 receiver can select one of these channels in order to receive an AV stream.

The ID channel for transmitters is usually set once during the setting up of the system while the receivers ID usually are the ones that are modified in order to show different content on the displays. The destination receiver ID must be set in the same channel as the transmitter broadcasting the desired source audio and video content.

The ID channel can be selected in four different ways:

- By front panel buttons of the devices (VEO-XTI1CG2 has the ID assignment blocked by default and should be adjusted entering CFN mode, long pressing DOWN button. See chapter [Additional functionalities of CH select ▲/▼ buttons for both: VEO-XTI1CG2 AND VEO-XRI1CG2](#)). [“Button Fast Setting Local ID” can be enabled to unblock ID assignment for VEO-XTI1CG2 front buttons CH select regular operation. See chapter VEO-XTI1CG2 Settings for further details.](#)
- By using the Web Page configuration on the same device.
- By using the Web Page configuration on VEO-XCTRLG2.
- Via RS-232.
- Via TCP using the VEO-XCTRLG2.

## 4.2.3 UNICAST MODE

When VEO-XTI1CG2 and VEO-XRI1CG2 devices are **connected as a simple point to point extension, no additional configuration is needed.**



1. Connect the source device to the VEO-XTI1CG2 transmitter to the HDMI port.
2. Connect Audio IN/OUT to a sound device and select the required audio mode.
3. Connect the remote endpoint to the VEO-XRI1CG2 receiver's HDMI port output.
4. Connect the transmitter and receiver with Cat5e/6/7 cable.
5. Connect an RS-232 cable from the automation system to the transmitter port.
6. Connect RS-232 cable from the receiver to the port of the device to control.
7. Power VEO-XTI1CG2 transmitter and VEO-XRI1CG2 receiver with the included power adapter.

**!** Set the same ID for both devices.

#### 4.2.4 MULTICAST MODE

When VEO-XTI1CG2 and VEO-XRI1CG2 devices are **connected in a point to multipoint or multipoint to multipoint topology, every transmitter and receiver should have a unique IP address**. When possible, it is recommended to create an independent IP video network using managed network switches. Use of gigabit switches with an IGMP support will create the most appropriate scenario.

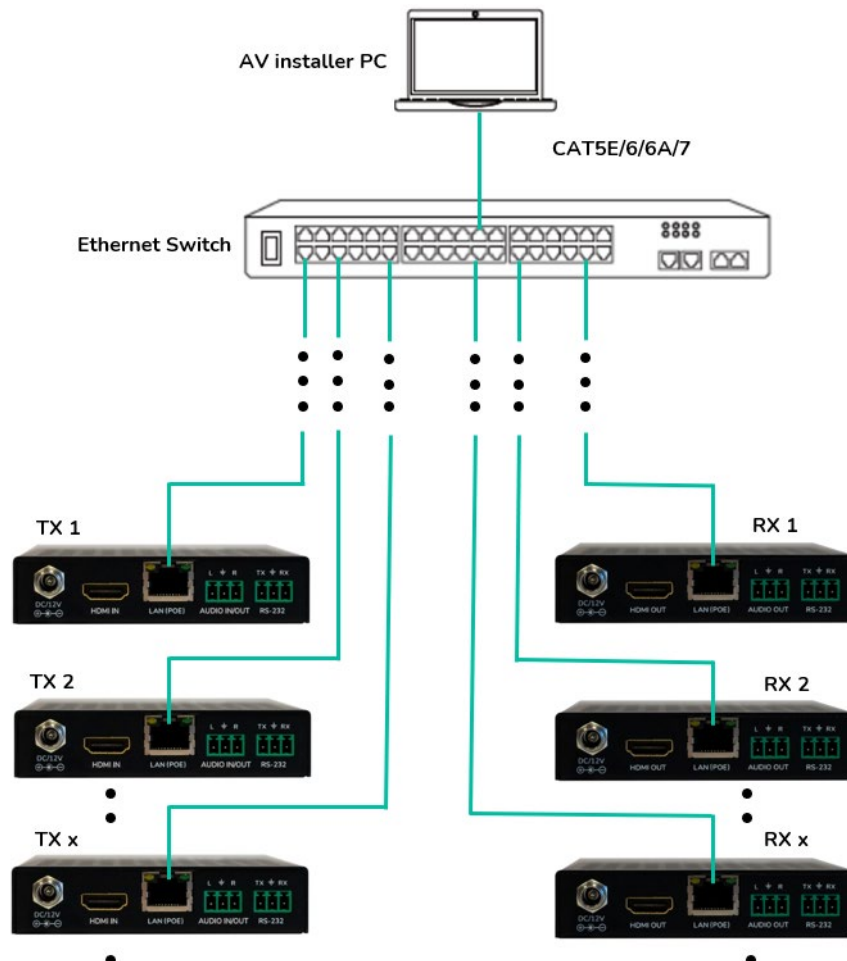

1. **Set the IP address** for each transmitter and receiver.
2. **Connect the source devices** to the HDMI ports of the VEO-XTI1CG2 transmitters.
3. **Connect the HDMI endpoints** to the HDMI ports of the VEO-XRI1CG2 receivers.
4. **Connect Audio IN/OUT** to a sound device and select the required audio mode.
5. **Connect an RS-232 cable** from the automation system to the transmitters ports.
6. **Connect RS-232 cables** from the receivers to the ports of the devices to control.
7. **Connect all VEO devices** to the network switch using Cat. 5e/6/7 cables.
8. **Power VEO-XTI1CG2 transmitter and VEO-XRI1CG2 receiver** with the included power adapter and power the switch. In case the switch supports PoE (Power over Ethernet), it will not be necessary to power the VEO devices locally.
9. **Choose the desired ID channel** for each of the VEO devices in order to establish the required video transmission flows.

PRECAUTIONS
PACKAGE CONTENTS
DESCRIPTION & FEATURES
INSTALL & CONNECT
START-UP & OPERATION
PANEL FUNCTIONS
TECHNICAL DATA

## 5. START-UP and OPERATION

### 5.1 CONFIGURATION USING WEB INTERFACE

VEO-XTI1CG2 and VEO-XRI1CG2 devices can be configured through their own built-in web interface by simply typing the IP address of the chosen device into a web browser. [Refer to chapter Setting the IP address for further details on how to find the IP address of a VEO-XTI1CG2 and VEO-XRI1CG2.](#)

The default credentials to log in are:

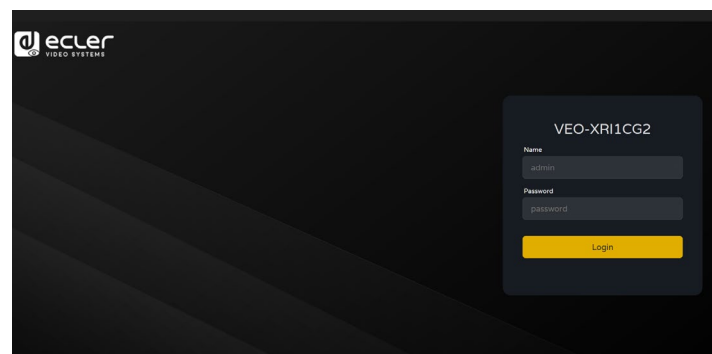

- **User name:** admin
- **Password:** admin

Once the login credentials have been filled out correctly, the **menus of the web settings page will let the user manage and operate different aspects and functionalities concerning transmitter and receiver operation, as explained in the next chapters.**

#### 5.1.1 INFORMATION

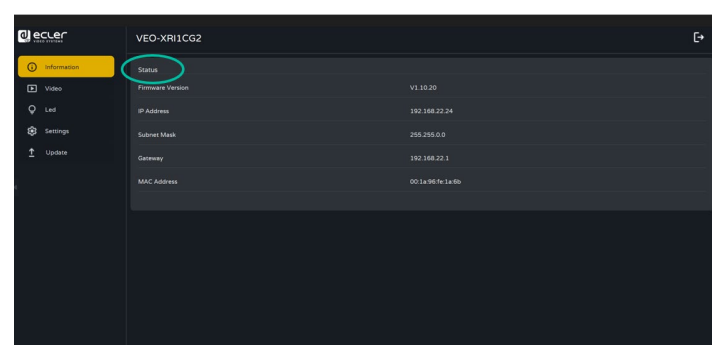

The Status page **provides basic information** about VEO-XTI1CG2 and VEO-XRI1CG2 such as:

- Firmware Version
- IP Address
- Subnet Mask
- Gateway
- MAC Address

## 5.1.2 VIDEO SETTINGS

### 5.1.2.1 VEO-XTI1CG2 VIDEO SETTINGS

The video settings page will enable the user to configure the following parameters for VEO-XTI1CG2.

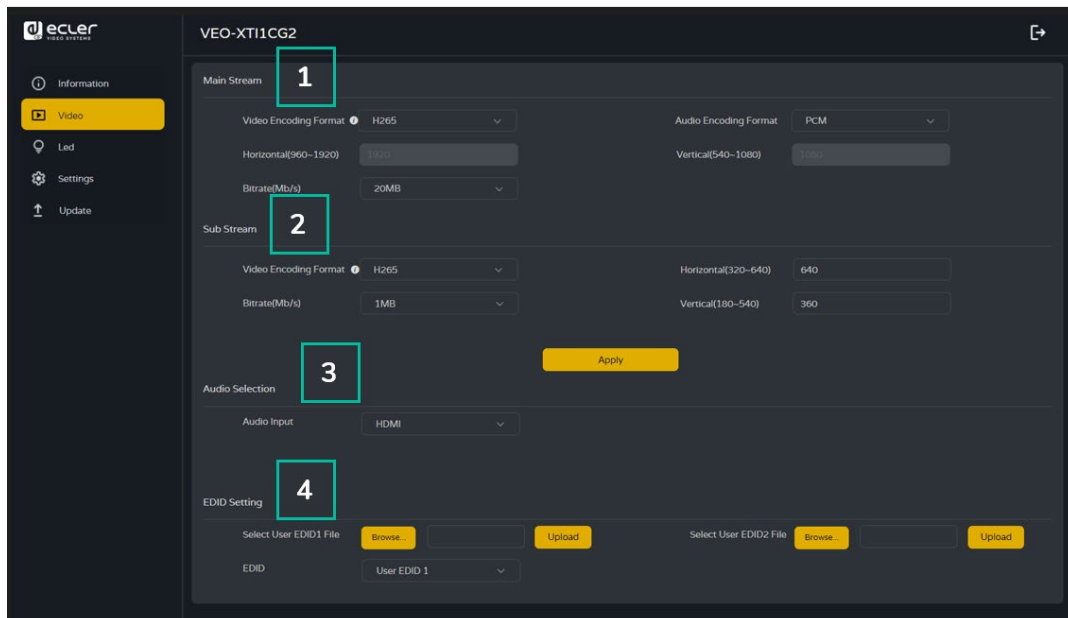

#### 1. Main Stream

- **Video Encoding Format:** the user can select H.265 and H.264 video codec for the mainstream.
- **Audio Encoding Format:** the user can select PCM or AAC audio for the mainstream.
- **Resolution:** it shows the HORIZONTAL and VERTICAL resolution for the mainstream. This setting follows the input resolution of the video source.
- **Bitrate:** the user can adjust the video quality choosing the maximum transmitted data for the mainstream.

#### 2. Sub Stream

- **Video Encoding Format:** the user can select H.265 and H.264 video codec for the sub stream.
- **Resolution:** the user can set the HORIZONTAL and VERTICAL resolution for the sub stream.
- **Bitrate:** the user can adjust the video quality choosing the maximum transmitted data for the sub stream.



PRECAUTIONS

PACKAGE CONTENTS

DESCRIPTION & FEATURES

INSTALL & CONNECT

START-UP & OPERATION

PANEL FUNCTIONS

TECHNICAL DATA

### 3. Audio Selection

This parameter lets the user choose the Audio mode (ANALOGUE / HDMI) for the VEO-XTI1CG2 transmitter's AUDIO IN.

- **ANALOGUE:** audio signal coming from the external analogue source connected to AUDIO IN is embedded in the HDMI signal flow and outputted through AUDIO OUT connector in VEO-XRI1CG2.
- **HDMI:** embedded audio in the HDMI signal flow is outputted through AUDIO OUT connector both in VEO-XTI1CG2 and VEO-XRI1CG2 connectors.

### 4. EDID Setting

This parameter selects the EDID setting for the VEO-XTI1CG2 transmitter. For further details, refer to [Additional functionalities of CH select ▲/▼ buttons for both: VEO-XTI1CG2 & VEO-XRI1CG2](#) chapter to check the available options.

EDID ID	EDID Description
00	Video: HDMI 1080p@60Hz / Audio: Stereo PCM
01	Video: HDMI 720p@60Hz / Audio: Stereo PCM
02	Video: DVI 1024p@60Hz
03	Video: DVI 1080p@60Hz
04	Video: DVI 1200p@60Hz
05	Video: HDMI 1200p@60Hz / Audio: Stereo PCM
06	Copy from VEO-XRI1CG2 HDMI output
07	USER 1
08	USER 2



**User EDID 1 and User EDID 2 can be uploaded** in SELECT USER EDID 1 FILE and SELECT USER EDID2 FILE. (This file can be downloaded from the Download EDID of the Receiver Video page).

PRECAUTIONS
PACKAGE CONTENTS
DESCRIPTION & FEATURES
INSTALL & CONNECT
START-UP & OPERATION
PANEL FUNCTIONS
TECHNICAL DATA

### 5.1.2.2 VEO-XRI1CG2: VIDEO SETTINGS

The video settings page will **enable the user to configure the following parameters for VEO-XRI1CG2.**

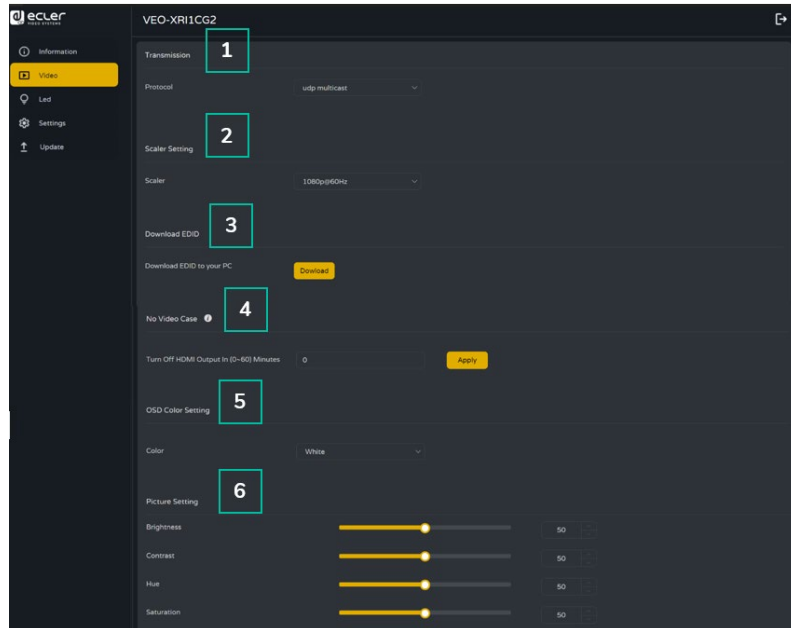

#### 1. Transmission

This parameter selects UNICAST or MULTICAST as the chosen network transmission protocol.

#### 2. Scaler Setting

This parameter sets the output resolution scaling up on the HDMI OUT of the VEO-XRI1CG2 receiver.

Resolution ID	Resolution Description
00	Pass-through
01	1080p@60Hz
02	1080p@50Hz
03	1080p@30Hz
04	1080p@25Hz
05	1080p@24Hz
06	720p@60Hz
07	720p@50Hz
08	576@50Hz
09	480@60Hz
10	640x480@60Hz
11	800x600@60Hz
12	1024x768@60Hz
13	1280x800@60Hz
14	1280x1024@60Hz
15	1366x768@60Hz
16	1440x900@60Hz
17	1600x1200@60Hz
18	1680x1050@60Hz
19	1920x1200@60Hz

### 3. Download EDID

This parameter enables the user to download the EDID binary file of the endpoint device connected to the VEO-XRI1CG2 receiver. The EDID file can be used as the User EDID file to be uploaded to the VEO-XTI1CG2.

### 4. Video Timeout Setting

This parameter sets the timeout time to turn off the HDMI OUT output when no video signal is detected. Selecting “0” disables this function.

### 5. OSD Color Setting

This section lets the user adjust the colour parameter of the data shown in the screen.

### 6. Picture Setting

This section lets the user adjust video parameters (Brightness, Contrast, Hue and Saturation) to better fit the output display and deliver the most appropriate video experience possible.



PRECAUTIONS

PACKAGE CONTENTS

DESCRIPTION & FEATURES

INSTALL & CONNECT

START-UP & OPERATION

PANEL FUNCTIONS

TECHNICAL DATA

### 5.1.3 LED

This page allows the user to **select the led status for both, VEO-XTI1CG2 and VEO-XRI1CG2.**

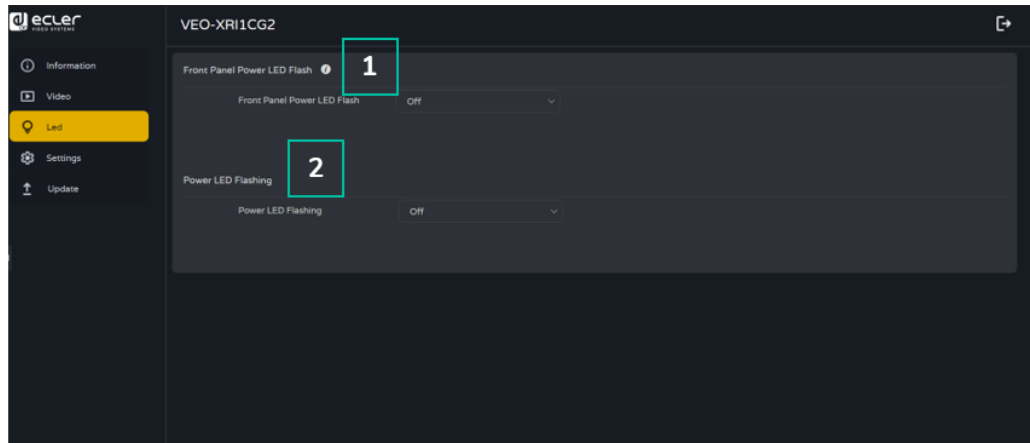

#### 1. Front Panel Power LED Flash:

This parameter selects the status of the Front Panel LED as follows:

- ON: The LED remains permanently lighted.
- OFF: After 90s the LED is switched off automatically.

#### 2. Power LED Flashing:

- ON: The Power LED remains permanently blinking.
- OFF: The Power LED stays on without blinking.
- ON 90s: The Power LED blinks for 90s and then stops.



## 5.1.4 SETTINGS

### 5.1.4.1 VEO-XTI1CG2 SETTINGS

This page allows the user to modify the network configuration of the VEO-XTI1CG2 device.

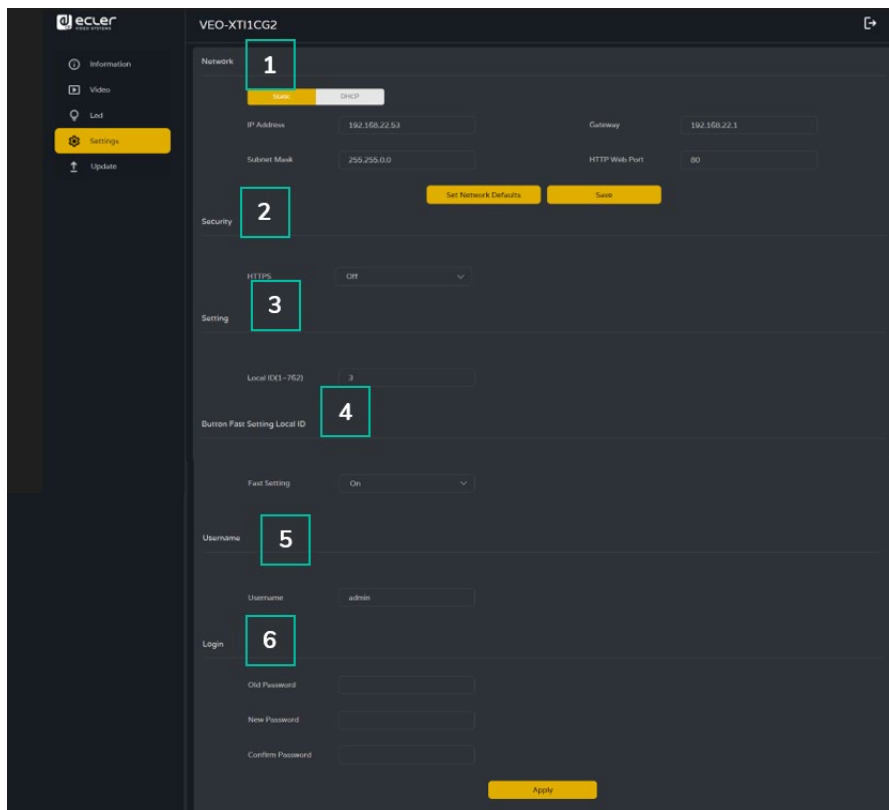

#### 1. Network

- IP address
- Subnet Mask
- Gateway
- HTTP Web Port

**!**

- The Network Settings can be set only when the MODE button is set to Static.
- After any changes to the network settings, username or password, the user will have to log in the Web GUI again with the new settings to resume working.

#### 2. Security

This parameter turns on or off HTTPS security protocol.

#### 3. Setting

**Local ID:** this parameter sets the ID Channel for the VEO-XTI1CG2 transmitter from the 1-762 available profiles.



PRECAUTIONS

PACKAGE CONTENTS

DESCRIPTION & FEATURES

INSTALL & CONNECT

START-UP & OPERATION

PANEL FUNCTIONS

TECHNICAL DATA

#### 4. Button Fast Setting Local ID

**Fast Setting:** ON/OFF - This parameter enables the front buttons of the device so that the user can physically change the ID from the front panel of the device.

#### 5. Username

This parameter lets the user modify the username assigned to the device.

#### 6. Login

This section allows the user to change the current password to access the web settings page.

### 5.1.4.2 VEO-XRI1CG2 SETTINGS

This page allows the user to modify the network configuration of the VEO-XRI1CG2 device.

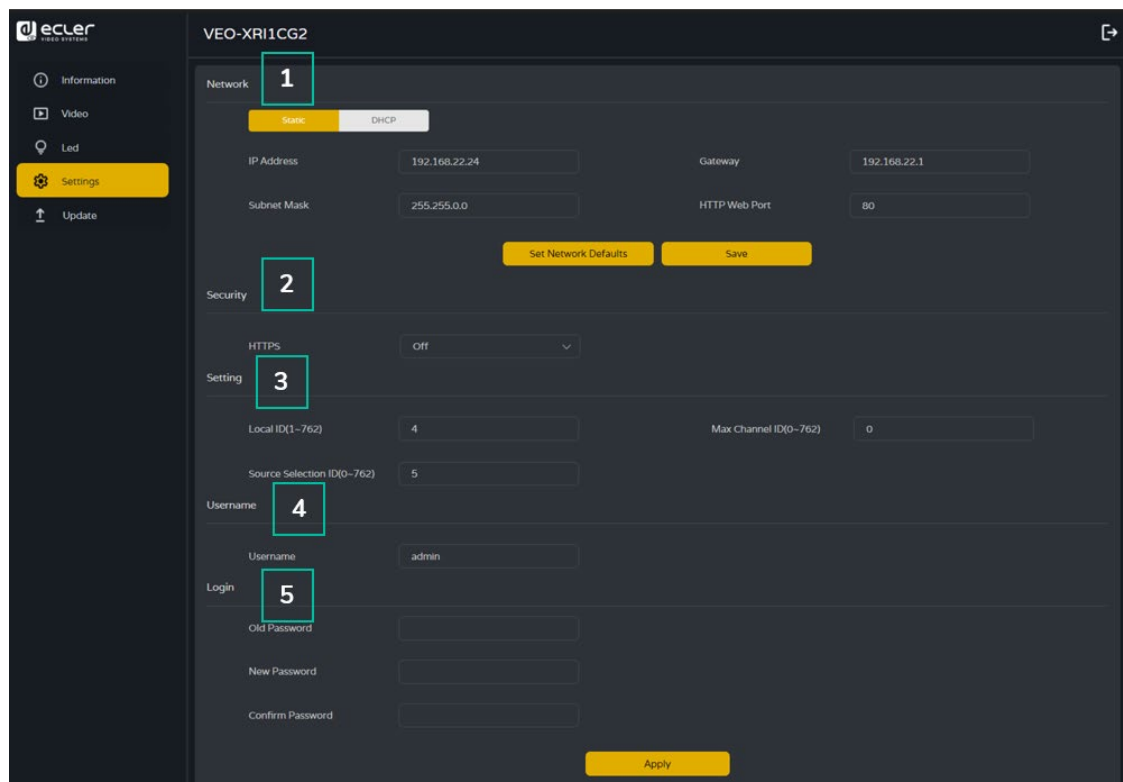

#### 1. Network

- IP address
- Subnet Mask
- Gateway
- HTTP Web Port



- The Network Settings can be set only when the MODE button is set to Static.
- After any changes to the network settings, username or password, the user will have to log in the Web GUI again with the new settings to resume working.

## 2. Security

This parameter turns on or off HTTPS security protocol.

## 3. Setting

- **Local ID:** this parameter sets the ID Channel for the VEO-XRI1CG2 receiver from the 0-762 available profiles.
- **Max Channel ID:** this parameter sets the range of ID Channel that will be available in the VEO-XRI1CG2 devices included in a given installation. Selecting “0” will enable the complete range of 0-762 channels.
- **Source Selection ID:** this parameter sets the transmission channel for the VEO-XRI1CG2 receiver from the 0-762 available channels. When both a transmitter and a receiver are tuned in the same channel, video will show from the VEO-XRI1CG2 HDMI output.

## 4. Username

This parameter lets the user modify the username assigned to the device.

## 5. Login

This section allows the user to change the current password to access the web settings page.

### 5.1.5 UPDATE

#### 5.1.5.1 VEO-XTI1CG2 UPDATE

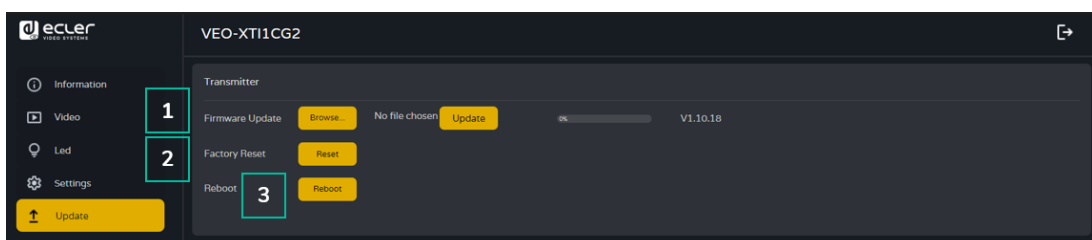

#### 1. Firmware Update:

- **Browse:** This will import the upgrade file.
- **Update:** This will start the upgrade process. When the progress bar reaches 100%, the upgrade is successful, and the device will restart.

2. **Factory Reset:** This will reset the device to the factory default settings.

3. **Reboot:** This will reboot the device.

HOME
PRECAUTIONS
PACKAGE CONTENTS
DESCRIPTION & FEATURES
INSTALL & CONNECT
START-UP & OPERATION
PANEL FUNCTIONS
TECHNICAL DATA

### 5.1.5.2 VEO-XRI1CG2 UPDATE

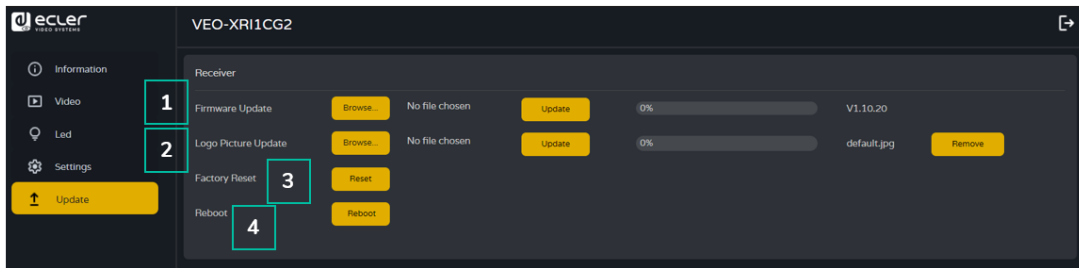

#### 1. Firmware Update:

- **Browse:** This will import the upgrade file.
- **Update:** This will start the upgrade process. When the progress bar reaches 100%, the upgrade is successful, and the device will restart.

#### 2. IMG Update:

- **Browse:** This will import the splash screen file.
- **Update:** This will start the update the splash screen image that will show on the receiver when the input source is disconnected.

#### 3. Factory Reset: This will reset the device to the factory default settings.

#### 4. Reboot: This will reboot the device.

### 5.1.6 LOG OUT

Selecting Log Out  will exit the Web GUI and skip to the login interface automatically.

## 5.2 REMOTE CONTROLLING

### 5.2.1 RS-232

To **match the ID from a transmitter to a receiver**, connect the RS-232 port of VEO-XTI1CG2 and VEO-XRI1CG2 to a PC serial interface or a RS-232 control system or use VEO-XCTRLG2 optional controller module.

#### 5.2.1.1 RS-232 COMMUNICATION PROTOCOL

The **serial parameters for a correct transmission** are:

Baud rate 115200    Data bits 8    Stop bits 1    Parity None    Flow control None

PRECAUTIONS
PACKAGE CONTENTS
DESCRIPTION & FEATURES
INSTALL & CONNECT
START-UP & OPERATION
PANEL FUNCTIONS
TECHNICAL DATA

### 5.2.1.2 COMMAND LIST

It is important to add carriage return (<CR>,\r,0x0D) and line feed (<LF>,\n,0x0A) characters at the end of each command:

**How do you have to enter the command?**

To launch a remote control command, it needs to be written as follows:

“<Command> [Param 1] <Variable> [Param 2]”

[Param 1], [Param 2] will not always be required for every command.

#### EXAMPLE OF USE:

Switch the channel of transmission of a VEO-XRI1CG2 (Rx) to receive the content of a VEO-XTI1CG2 (Tx) :

- VEO-XTI1G2: "Local ID" parameter defines a unique ID for the transmitter as well as the transmission channel.
- VEO-XRI1CG2: "Local ID" parameter defines a unique ID for the receiver. "Source Local ID" defines the transmission channel in which the receiver is tuned to.

[See chapter “Startup and Operation” for further details.](#)

The command to use is “SET DEC [dec] SWITCH [enc] ALL”

“SET DEC 1 SWITCH 2 ALL\r\n”

VEO-XRI1CG2 with Local ID 1 will switch its “Source local ID” to 2, tuning all services (video, audio, RS-232) to channel transmission 2 assigned the VEO-XTI1CG2 with “Local ID” 2.

Transmitter and Receiver Control		
Command	Variable	Description
SET ENC [enc] <sup>(1)</sup> or SET DEC [dec] <sup>(2)</sup>	ID [id] <ul style="list-style-type: none"> <li>• id = [1..762]</li> </ul>	Set the index ID of the transmitter or receiver.
SET ENC [enc] <sup>(1)</sup>	EDID COPY [dec] <sup>(2)</sup>	Set the transmitter EDID copy from receiver.
	EDID DEFAULT [edid] <ul style="list-style-type: none"> <li>• edid = 00: HDMI 1080p@60Hz, Audio 2CH PCM 01: HDMI 720p@60Hz, Audio 2CH PCM 02: DVI 1280x1024@60Hz, Audio None 03: DVI 1920x1080@60Hz, Audio None 04: DVI 1920x1200@60Hz, Audio None 05: HDMI 1920x1200p@60Hz, Audio 2CH PCM 06: Copy EDID</li> </ul>	Set the transmitter Default EDID.

	07: User EDID 1 08: User EDID 2	
SET DEC [dec] <sup>(2)</sup> SWITCH [enc] <sup>(1)</sup>	ALL	Set the receiver switch all signals. Note: enc=0 mean no source in this case
SET DEC [dec] <sup>(2)</sup>	OUTPUT RESOLUTION [res] <ul style="list-style-type: none"> <li>res =</li> </ul> [0:Bypass 1:1080p@60 2:1080p@50 3:1080p@30 4:1080p@25 5:1080p@24 6:720p@60 7:720p@50 8:576p@50 9:480p@60 10:640x480@60 11:800x600@60 12:1024x768@60 13:1280x800@60 14:1280x1024@60 15:1366x768@60 16:1440x900@60 17:1600x1200@60 18:1680x1050@60 19:1920x1200@60]	Set the receiver output resolution.
	PERMISSION [enc]r	Set the maximum transmitter ID number for the receiver to switch signals through buttons.
GET MAC\r		Get MAC of the transmitter/receiver.

<sup>(1)</sup>enc=000: All transmitter  
 enc=[001...762]: One transmitter

<sup>(2)</sup>dec=000: All receiver  
 dec=[001...762]: One receiver

-  • **Any TX can control any TXs and RXs.** The following api items 1 to 7 all can be used.
- **RX can only set parameters for the device connected to serial port,** and only api 1 to 4 and the api 7 can be used.

## 5.2.2 ADVANCED NETWORK MANAGEMENT

For larger AV over IP multicast scenarios involving several VEO-XTI1CG2 and VEO-XRI1CG2 devices, it is recommended to add a VEO-XCTRLG2 controller module in the system. This unit will allow the user to manage and operate all the transmitters and receivers from a unique Web interface, including Preview mode, Matrix control, Video Wall management control or even the use of TCP commands to remotely communicate with VEO-XTI1CG2 and VEO-XRI1CG2 units present in the network. For further details on how to set up an advanced networked installation control layout interface, please refer to [VEO-XCTRLG2 controller module user manual](#).

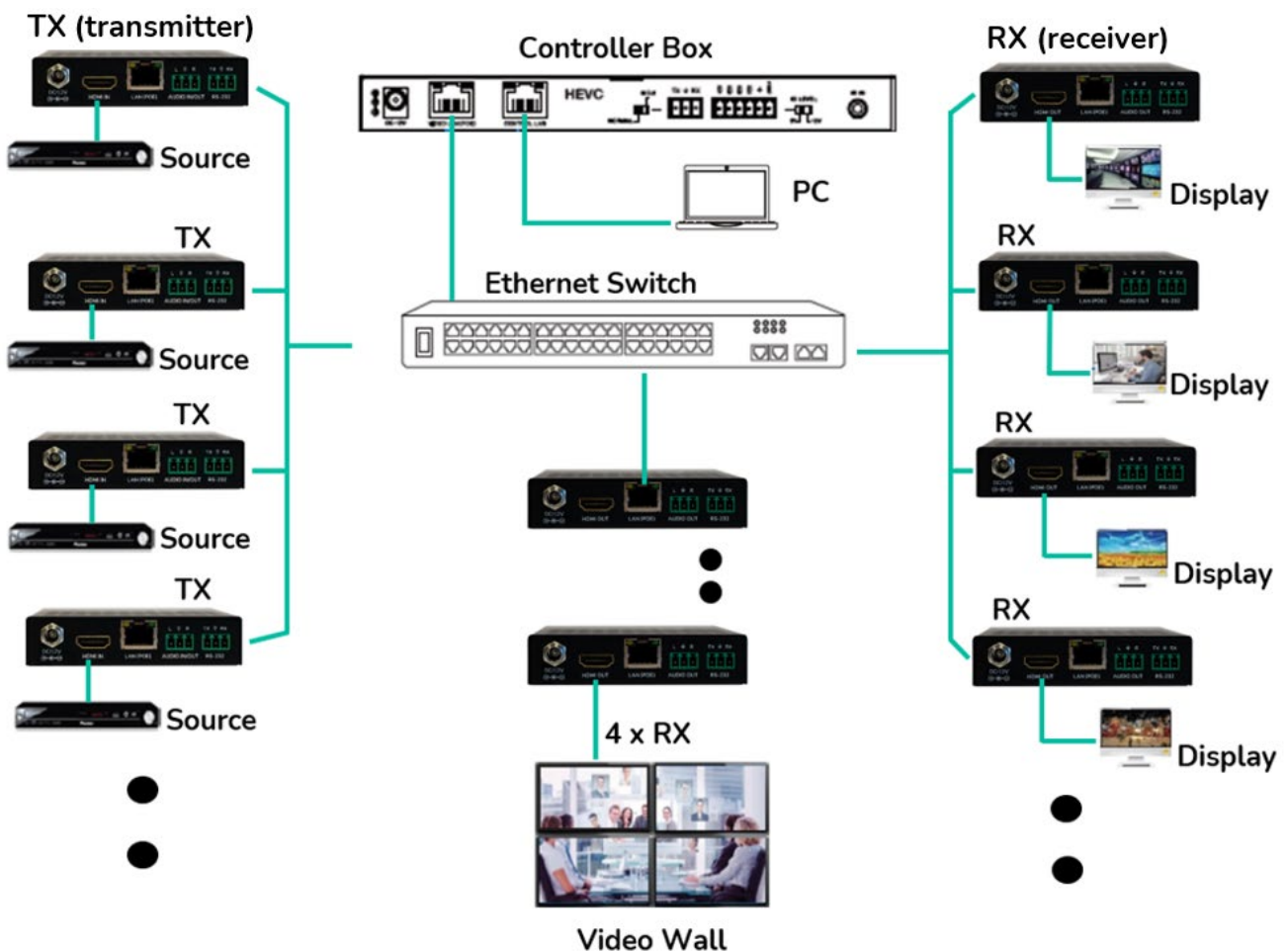

PRECAUTIONS
PACKAGE CONTENTS
DESCRIPTION & FEATURES
INSTALL & CONNECT
START-UP & OPERATION
PANEL FUNCTIONS
TECHNICAL DATA

## 6. PANEL FUNCTIONS

### 6.1 VEO-XTI1CG2 (TX, TRANSMITTER)

#### 6.1.1 FRONT PANEL

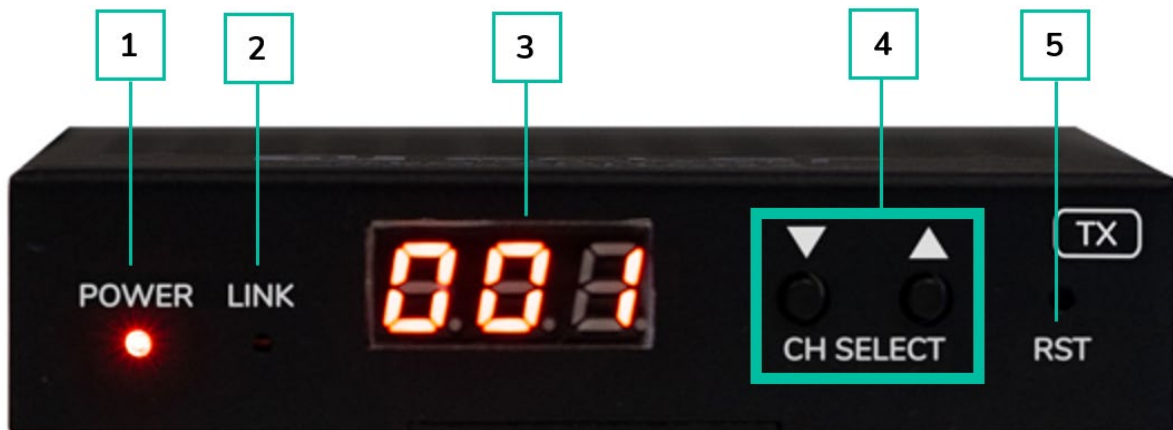

1. **POWER LED:** The LED flashes when the device is power supplied and stays lid (RED) after the start up is complete.
2. **LINK LED:** Network connection status LED:
  - **Light on:** Network connection is stable and there's a compatible video signal.
  - **Light off:** No network connection.
  - **Light flashing (slow):** Network connection is stable but there's no video signal.
  - **Light flashing (fast):** Network connection is stable but there's no compatible video signal (resolution or frame rate are greater than native).
3. **STATUS DISPLAY:** indicates current ID channel and further device information. When clicking the "SHOW ME" option on the VEO-XCTRLG2, the status display will flash "SHO" for an easier location of the corresponding device. For further details, refer to [Additional functionalities of CH select ▲/▼ buttons for both: VEO-XTI1CG2 & VEO-XRI1CG2](#) chapter.
4. **CH SELECT (▲UP/▼DOWN):** Use these buttons to set the ID channel of the device. It is also possible to adjust audio mode, manage EDID, consult IP address, or enter configuration mode. For further details, refer to [Additional functionalities of CH select ▲/▼ buttons for both: VEO-XTI1CG2 & VEO-XRI1CG2](#) chapter.
5. **RESET:** System reset button. Pressing and holding for 5 seconds will restart and restore factory settings on the device.



PRECAUTIONS

PACKAGE CONTENTS

DESCRIPTION & FEATURES

INSTALL & CONNECT

START-UP & OPERATION

PANEL FUNCTIONS

TECHNICAL DATA



## 6.1.2 REAR PANEL

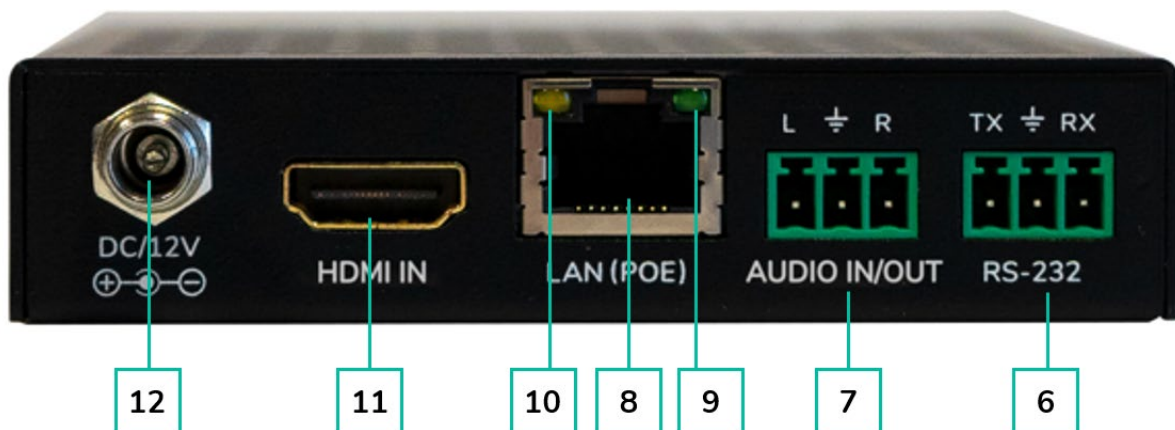

**6. RS-232:** Serial port for remote control. Signal pass-through supported.

**7. AUDIO IN/OUT:**

- **AUDIO IN:** When this mode is selected, the audio port acts as an input (audio embedding to HDMI).
- **AUDIO OUT:** When this mode is selected, the audio port acts as an output (audio extraction from HDMI).

**8. LAN (PoE) CONNECTOR:** Connect the 1Gb network port to an Ethernet switch to begin data transmission. When PoE on the Ethernet switch is available, the device will not need to be locally powered.

**9. LINK indication (Green):**

- **Light ON:** The network cable is correctly connected.
- **Light OFF:** No Network connection.

**10. DATA Indicator (Yellow):**

- **Flashing:** Data transmission
- **Light OFF:** No Data transmission

**11. HDMI IN:** HDMI input port

**12. DC 12V PORT:** Connect this port to the 12VDC included power supply.

## 6.2 VEO-XRI1CG2 (RX, RECEIVER)

### 6.2.1 FRONT PANEL

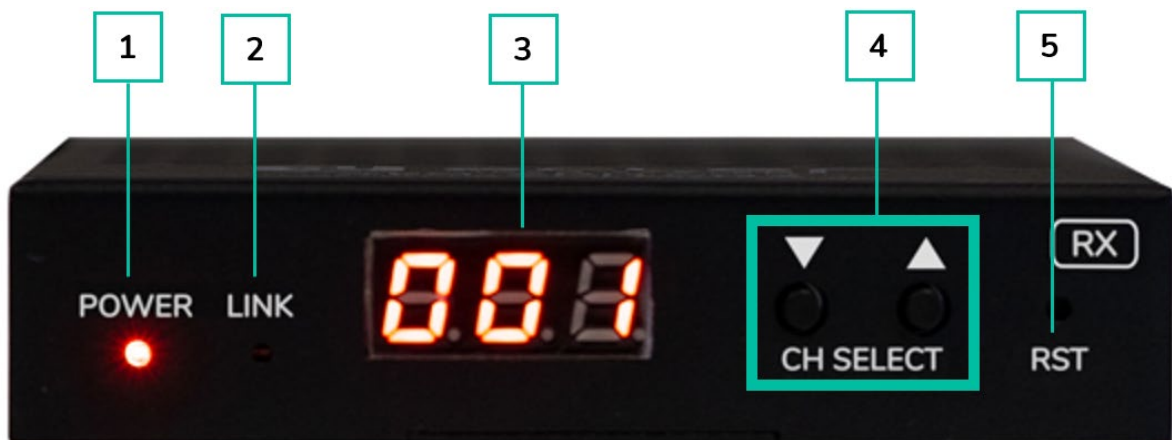

1. **POWER LED:** The LED flashes when the device is power supplied and stays lid (RED) after the start up is complete.
2. **LINK LED:** Network connection status LED:
  - **Light on:** Network connection is stable and there's a compatible video signal.
  - **Light off:** No network connection.
  - **Light flashing (slow):** Network connection is stable but there's no video signal.
  - **Light flashing (fast):** Network connection is stable but there's no compatible video signal (resolution or frame rate are greater than native).
3. **STATUS DISPLAY:** indicates current ID channel and further device information. When clicking the "SHOW ME" option on the XCTRLG2, the status display will flash "SHO" for an easier location of the corresponding device. For further details, refer to [Additional functionalities of CH select ▲/▼ buttons for both: VEO-XTI1CG2 & VEO-XRI1CG2](#) chapter.
4. **CH SELECT (▲UP/▼DOWN):** Use these buttons to set the ID channel of the device. It is also possible to adjust audio mode, manage EDID, consult IP address, or enter configuration mode. For further details, refer to [Additional functionalities of CH select ▲/▼ buttons for both: VEO-XTI1CG2 & VEO-XRI1CG2](#) chapter.
5. **RESET:** System reset button. Pressing and holding for 5 seconds will restart and restore factory settings on the device.

## 6.2.2 REAR PANEL

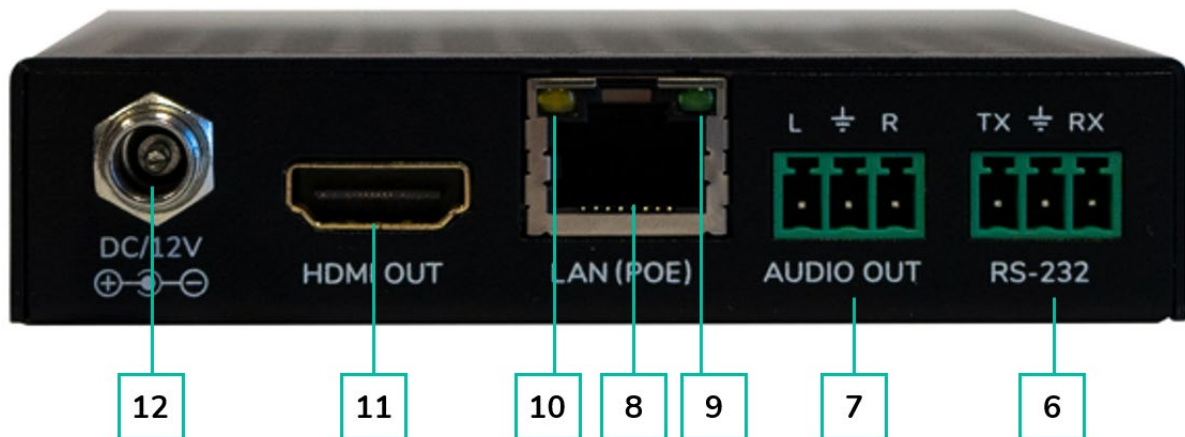

6. **RS-232:** Serial port for remote control. Signal pass-through supported.
7. **AUDIO OUT:** The audio port acts as an audio de-embedder from HDMI.
8. **LAN (PoE) CONNECTOR:** Connect the 1Gb network port to an Ethernet switch to begin data transmission. When PoE on the Ethernet switch is available, the device will not need to be locally powered.
9. **LINK indication (Green):**
  - **Light ON:** The network cable is correctly connected.
  - **Light OFF:** No Network connection.
10. **DATA Indicator (Yellow):**
  - **Flashing:** Data transmission.
  - **Light OFF:** No Data transmission.
11. **HDMI OUT:** HDMI output port.
12. **DC 12V PORT:** Connect this port to the 12VDC included power supply.



PRECAUTIONS

PACKAGE CONTENTS

DESCRIPTION & FEATURES

INSTALL & CONNECT

START-UP & OPERATION



PANEL FUNCTIONS

TECHNICAL DATA

### 6.3 ADDITIONAL FUNCTIONALITIES OF CH SELECT ▲/▼ BUTTONS FOR BOTH: VEO-XTI1CG2 AND VEO-XRI1CG2

Settings	Buttons Pressed	Description
IP Address	▲	Pressing and holding the ▲ button for 5 seconds will show the current IP address of VEO-XTI1CG2 or VEO-XRI1CG2 device in the Status display. This message will appear following the sequence "xxx", "xxx", "xxx", "xxx".
ID	▼	Pressing and holding the ▼ button for 5 seconds will show the current IDs of VEO-XTI1CG2 or VEO-XRI1CG2 device in the Status display. This message will appear following the sequence "xxx",
Wake up	▲ or ▼	After the system is powered on, the VEO-XTI1CG2 / VEO-XRI1G2 device Status display will show the ID Channel. When idle and Display configured as OFF, pressing ▲ or ▼ button will turn on the Status display and show the current ID Channel number (e.g. 001).
Configuration	▲ and ▼	<p>Pressing and holding ▲ and ▼ buttons together at the same time for 5 seconds will enter the "Configuration" mode with "CFN" displaying on the status display. Further long pressing of ▲ and ▼ buttons will allow to confirm and enter in the next configuration menu.</p> <p>Available menus are:</p> <ul style="list-style-type: none"> <li>• ID modifying.</li> <li>• EDID settings.</li> <li>• Audio Settings.</li> <li>• Output Resolution Settings (Only VEO-XRI1CG2).</li> <li>• Video Timeout Settings (Only VEO-XRI1CG2).</li> </ul>
ID Settings	▲ and ▼	<p>For VEO-XRI1C2G receivers the ID can be changed just pressing the ▲ or ▼ buttons and this allows to receive the desired streaming from the transmitter. VEO-XTI1CG2 Transmitter ID must be unique in a network so the procedure to change the ID is not so immediate.</p> <p>Pressing and holding ▲ and ▼ buttons both together at the same time for 5 seconds will enter the "ID Settings" mode. The ID Channel will flash, then pressing the ▲ or ▼ button will select the desired ID Channel and pressing and hold ▲ and ▼ buttons once again both together at the same time for 5 seconds, will confirm the selected ID Channel and exit "ID Settings" mode and go to the next menu.</p>

- HOME
- PRECAUTIONS
- PACKAGE CONTENTS
- DESCRIPTION & FEATURES
- INSTALL & CONNECT
- START-UP & OPERATION
- PANEL FUNCTIONS
- TECHNICAL DATA

<p><b>EDID Settings (only VEO-XTI1CG2)</b></p>	<p>▲ and ▼</p>	<p>After showing ID settings menu, long pressing the ▲ or ▼ button until the Status display shows “E00” (in which “E” refers to EDID, “00” to EDID ID) in the Status display. Then pressing and holding ▲ and ▼ buttons both together at the same time buttons for 5 seconds will enter “EDID Settings” mode. The EDID ID number (e.g. E01) on the Status display will flash. Then pressing the ▲ or ▼ button will select the desired EDID ID:</p> <table border="1" data-bbox="639 539 1407 983"> <thead> <tr> <th>EDID ID</th> <th>EDID Description</th> </tr> </thead> <tbody> <tr> <td>00</td> <td><u>Video</u>: HDMI 1080p@60Hz / <u>Audio</u>: Stereo PCM</td> </tr> <tr> <td>01</td> <td><u>Video</u>: HDMI 720p@60Hz / <u>Audio</u>: Stereo PCM</td> </tr> <tr> <td>02</td> <td><u>Video</u>: DVI 1024p@60Hz</td> </tr> <tr> <td>03</td> <td><u>Video</u>: DVI 1080p@60Hz</td> </tr> <tr> <td>04</td> <td><u>Video</u>: DVI 1200p@60Hz</td> </tr> <tr> <td>05</td> <td><u>Video</u>: HDMI 1200p@60Hz / <u>Audio</u>: Stereo PCM</td> </tr> <tr> <td>06</td> <td>Copy from VEO-XRI1CG2 HDMI output</td> </tr> <tr> <td>07</td> <td>USER 1</td> </tr> <tr> <td>08</td> <td>USER 2</td> </tr> </tbody> </table> <div data-bbox="651 1037 1414 1263" style="border: 1px solid black; padding: 5px; margin-top: 10px;"> <p> • The default EDID of 1080p60 will be used if an EDID has not previously been copied to ID 06 or downloaded to ID 07/08 on VEO-XCTRLG2 Web GUI</p> <p>• EDID ID 06/07/08 are not available without VEO-XCTRLG2.</p> </div> <div data-bbox="651 1279 1414 1429" style="border: 1px solid black; padding: 5px; margin-top: 10px;"> <p> Pressing and holding ▲ and ▼ buttons both together for 5 seconds will confirm the selected EDID ID and exit “EDID Settings” mode.</p> </div>	EDID ID	EDID Description	00	<u>Video</u> : HDMI 1080p@60Hz / <u>Audio</u> : Stereo PCM	01	<u>Video</u> : HDMI 720p@60Hz / <u>Audio</u> : Stereo PCM	02	<u>Video</u> : DVI 1024p@60Hz	03	<u>Video</u> : DVI 1080p@60Hz	04	<u>Video</u> : DVI 1200p@60Hz	05	<u>Video</u> : HDMI 1200p@60Hz / <u>Audio</u> : Stereo PCM	06	Copy from VEO-XRI1CG2 HDMI output	07	USER 1	08	USER 2
EDID ID	EDID Description																					
00	<u>Video</u> : HDMI 1080p@60Hz / <u>Audio</u> : Stereo PCM																					
01	<u>Video</u> : HDMI 720p@60Hz / <u>Audio</u> : Stereo PCM																					
02	<u>Video</u> : DVI 1024p@60Hz																					
03	<u>Video</u> : DVI 1080p@60Hz																					
04	<u>Video</u> : DVI 1200p@60Hz																					
05	<u>Video</u> : HDMI 1200p@60Hz / <u>Audio</u> : Stereo PCM																					
06	Copy from VEO-XRI1CG2 HDMI output																					
07	USER 1																					
08	USER 2																					
<p><b>Audio Settings (only VEO-XTI1CG2)</b></p>	<p>▲ and ▼</p>	<p>After showing EDID menu, long pressing ▲ or ▼ button until the Status display shows “AHE”. Then pressing and holding ▲ and ▼ buttons both together for 5 seconds will enter the “Audio Settings” mode. The current audio mode will appear flashing. Pressing ▲ or ▼ button will select the desired option:</p> <ul style="list-style-type: none"> <li>• AHE: HDMI embedded audio signal will be outputted through AUDIO OUT ports on VEO-XTI1CG2 and VEO-XRI1CG2</li> <li>• AEI: External audio source signal coming in AUDIO IN on VEO-XTI1CG2 will be outputted through AUDIO OUT port on VEO-XRI1CG2.</li> </ul>																				

PRECAUTIONS
PACKAGE CONTENTS
DESCRIPTION & FEATURES
INSTALL & CONNECT
START-UP & OPERATION
PANEL FUNCTIONS
TECHNICAL DATA

<p style="text-align: center;"><b>Output Resolution Settings</b> (Only VEO-XRI1CG2)</p>	<p>▲ and ▼</p>	<p>Long pressing the ▲ or ▼ button until the Status display shows “S00” (in which “S” refers to Scaler and “00” to resolution ID). Then pressing and holding ▲ and ▼ buttons both together for 5 seconds, will enter the “Output Resolution Settings” mode. The Resolution ID number (e.g. S01) on the Status display will flash. Then pressing the ▲ or ▼ button will select the desired resolution ID:</p> <table border="1" data-bbox="691 533 1356 1435"> <thead> <tr> <th>Resolution ID</th> <th>Resolution Description</th> </tr> </thead> <tbody> <tr><td>00</td><td>Pass-through</td></tr> <tr><td>01</td><td>1080p@60Hz</td></tr> <tr><td>02</td><td>1080p@50Hz</td></tr> <tr><td>03</td><td>1080p@30Hz</td></tr> <tr><td>04</td><td>1080p@25Hz</td></tr> <tr><td>05</td><td>1080p@24Hz</td></tr> <tr><td>06</td><td>720p@60Hz</td></tr> <tr><td>07</td><td>720p@50Hz</td></tr> <tr><td>08</td><td>576@50Hz</td></tr> <tr><td>09</td><td>480@60Hz</td></tr> <tr><td>10</td><td>640x480@60Hz</td></tr> <tr><td>11</td><td>800x600@60Hz</td></tr> <tr><td>12</td><td>1024x768@60Hz</td></tr> <tr><td>13</td><td>1280x800@60Hz</td></tr> <tr><td>14</td><td>1280x1024@60Hz</td></tr> <tr><td>15</td><td>1366x768@60Hz</td></tr> <tr><td>16</td><td>1440x900@60Hz</td></tr> <tr><td>17</td><td>1600x1200@60Hz</td></tr> <tr><td>18</td><td>1680x1050@60Hz</td></tr> <tr><td>19</td><td>1920x1200@60Hz</td></tr> </tbody> </table> <div data-bbox="643 1491 1385 1641" style="border: 1px solid black; border-radius: 15px; padding: 10px; margin-top: 10px;"> <p> Pressing and holding ▲ and ▼ buttons both together for 5 seconds will confirm the selected Resolution ID and exit “Output Resolution Settings” mode</p> </div>	Resolution ID	Resolution Description	00	Pass-through	01	1080p@60Hz	02	1080p@50Hz	03	1080p@30Hz	04	1080p@25Hz	05	1080p@24Hz	06	720p@60Hz	07	720p@50Hz	08	576@50Hz	09	480@60Hz	10	640x480@60Hz	11	800x600@60Hz	12	1024x768@60Hz	13	1280x800@60Hz	14	1280x1024@60Hz	15	1366x768@60Hz	16	1440x900@60Hz	17	1600x1200@60Hz	18	1680x1050@60Hz	19	1920x1200@60Hz
Resolution ID	Resolution Description																																											
00	Pass-through																																											
01	1080p@60Hz																																											
02	1080p@50Hz																																											
03	1080p@30Hz																																											
04	1080p@25Hz																																											
05	1080p@24Hz																																											
06	720p@60Hz																																											
07	720p@50Hz																																											
08	576@50Hz																																											
09	480@60Hz																																											
10	640x480@60Hz																																											
11	800x600@60Hz																																											
12	1024x768@60Hz																																											
13	1280x800@60Hz																																											
14	1280x1024@60Hz																																											
15	1366x768@60Hz																																											
16	1440x900@60Hz																																											
17	1600x1200@60Hz																																											
18	1680x1050@60Hz																																											
19	1920x1200@60Hz																																											
<p style="text-align: center;"><b>Video Timeout Settings</b> (Only VEO-XRI1CG2)</p>	<p>▲ and ▼</p>	<p>Long pressing the ▲ or ▼ button until the Status display shows “H00” (in which “H” refers to HDMI TIMEOUT an “00” to the time in minutes. Then pressing and holding ▲ and ▼ buttons both together for 5 seconds, will enter the “Video Timeout Setting” mode. The number (e.g., H01) on the Status display will flash. Press the ▲ or ▼ button to select the desired time to disable the HDMI output after the VEO-XTI1CG2 HDMI input doesn’t detect video signal.</p>																																										

## 7. TECHNICAL DATA

### 7.1 TECHNICAL SPECIFICATIONS

#### VEO-XTI1CG2 / VEO-XRI1CG2

Video Performances	
Video Input Connector	Transmitter: HDMI Type A Female, 10.2 Gbps
Video Output connector	Receiver: HDMI Type A Female, 10.2 Gbps
Video Input Resolution	Up to 1920x1200 60Hz
Video Output Resolution	Up to 1920x1200 60Hz
Video Codec	H.265 and H.264
Transmission Latency	<100ms compression depending on video content and transmission / network configuration
Chroma Subsampling	RGB4:4:4, YCbCr 4:4:4, YCbCr 4:2:2
Colour Depth	8-bit, 10-bit, 12-bit, 16-bit (1080p@60Hz)
Colour Space	RGB, YCbCr
HDCP	1.4
HDR	Not supported
Video Composing Capabilities	Videowall up to 9x9
Scaling Feature	Supported
HDMI Distance	15m with Ecler VEO Cables
Audio Performances	
Audio Input Connectors	Transmitter: 3-pin Euroblock (Stereo Unbalanced)
Audio Output Connectors	Receiver and Transmitter: 3-pin Euroblock (Stereo Unbalanced)
Audio Formats	LPCM 2.0CH
Sample Rate	32/44.1/48KHz
Bit Depth	Up to 24-bit
Frequency Response	20Hz-20KHz
ARC/eARC	Not Supported
Control	
Control Connectors	RJ-45, Euroblock
Control Protocols	Web, TCP (only with VEO-XCTRLG2), RS-232
Control Buttons	1 x UP button 1 x DOWN button
EDID Management	Via front panel and Web settings
Status Indicators	POWER LED: Red; LINK LED: Green; LCD display
Pass-through Control	
Pass-through Connectors	Euroblock
Pass-through Protocols	RS-232
Network	
Network Connectors	RJ-45
Network Requirements	IGMP Snooping
Average Streaming Bitrate	Configurable via software 1- 20Mbps
Transmission Distance	100m (Ethernet Standard)
Electrical	
Power Supply	PoE (802.3af Class 3) or External Power supply
AC Mains Connector	100-240VAC 50-60Hz with EU, UK, US, AU blades
DC Mains Connector	12VDC-1A with coaxial DC connector
Power Consumption	Transmitter: 3W / Receiver: 3W



PRECAUTIONS

PACKAGE CONTENTS

DESCRIPTION & FEATURES

INSTALL & CONNECT

START-UP & OPERATION

PANEL FUNCTIONS

TECHNICAL DATA

## Physical

Operating Temperature	Min. -10°C - 14°F; Max. 45°C - 113°F
Operating Humidity	<90% HR
Installation Options	Desktop, 19" racks (1/2RU), VEO-RK1CG2
Included Accessories	<ul style="list-style-type: none"> <li>▪ 2x 3pins Euroblock connector</li> <li>▪ 4x M3 screws 4mm</li> <li>▪ 2x Mounting Ears</li> <li>▪ 1x 12V PSU</li> </ul>
Optional Accessories	VEO-XCTRLG2, VEO-RK1CG2
Dimensions (WxHxD)	95 x 21.5 x 120mm / 3.74 x 0.85 x 4.72in. (each one, TX and RX separately)
Shipping Dimensions (WxHxD)	188 x 75 x 137 mm / 7.40 x 2.95 x 5.39 in. (each one, TX and RX separately)
Weight	0.3 Kg / 0,66 lb (each one, TX and RX separately)
Shipping Weight	0.7 Kg (each one, TX and RX separately)
Chassis Material	Metal
Finished Colour	Black



PRECAUTIONS

PACKAGE CONTENTS

DESCRIPTION & FEATURES

INSTALL & CONNECT

START-UP & OPERATION

PANEL FUNCTIONS

TECHNICAL DATA



## 7.2 MECHANICAL DIAGRAM

### 7.2.1 VEO-XTI1CG2

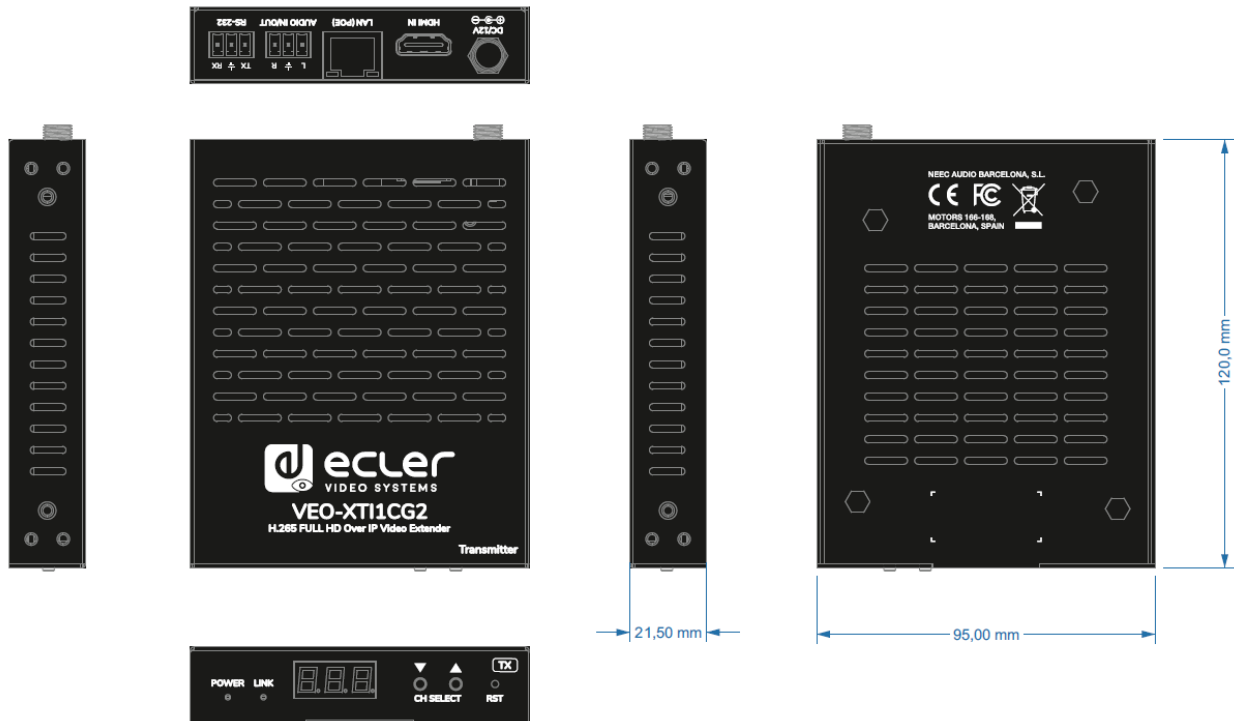

### 7.2.2 VEO-XRI1CG2

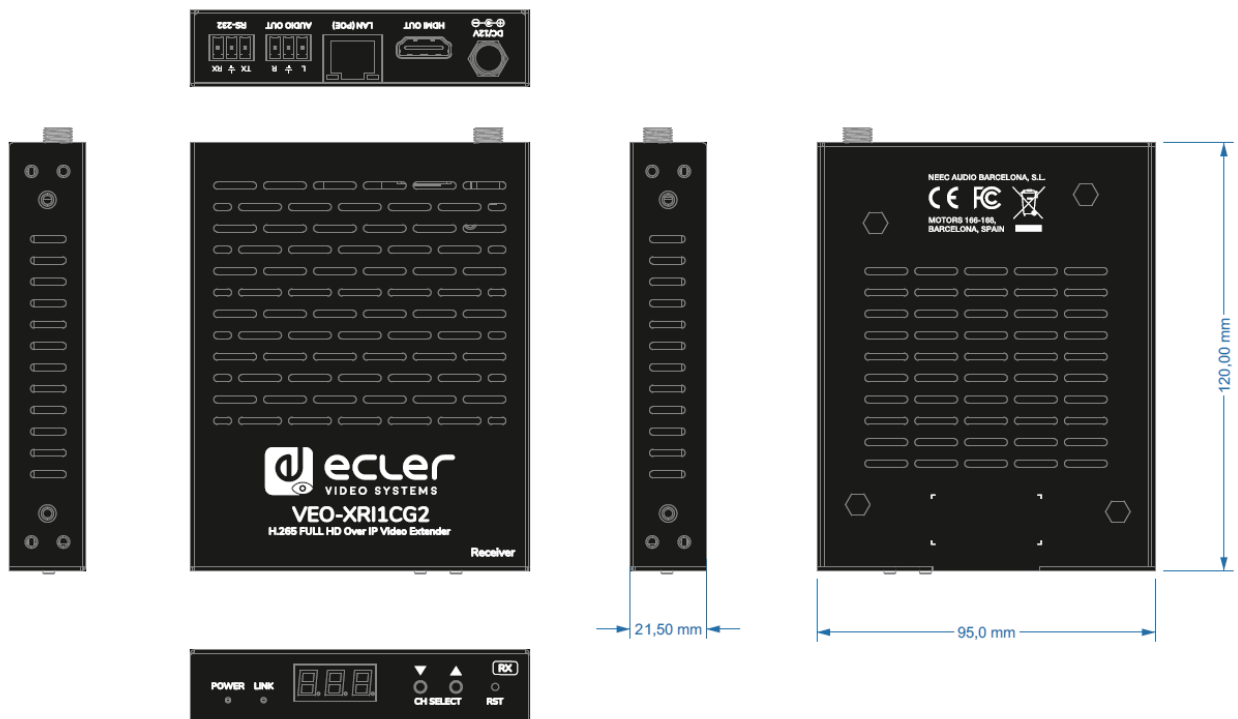

- 
- PRECAUTIONS
- PACKAGE CONTENTS
- DESCRIPTION & FEATURES
- INSTALL & CONNECT
- START-UP & OPERATION
- PANEL FUNCTIONS
- TECHNICAL DATA



PRECAUTIONS

PACKAGE  
CONTENTS

DESCRIPTION  
&  
FEATURES

INSTALL  
&  
CONNECT

START-UP  
&  
OPERATION

PANEL  
FUNCTIONS

TECHNICAL  
DATA



All product characteristics are subject to variation due to production tolerances. **NEEC AUDIO BARCELONA S.L.** reserves the right to make changes or improvements in the design or manufacturing that may affect these product specifications.

For technical queries contact your supplier, distributor or complete the contact form on our website, in [Support / Technical requests](#).

Motors, 166-168 -08038 Barcelona - Spain-(+34) 932238403 | [information@ecler.com](mailto:information@ecler.com) | [www.ecler.com](http://www.ecler.com)