

# VEO-MXH44D

MATRIXES

HDMI® 4x4 18Gbps Matrix with Audio De-embedders



## USER MANUAL



PRECAUTIONS

PACKAGE CONTENTS

DESCRIPTION & FEATURES

INSTALL & CONNECT

START-UP & OPERATION

WebGUI

FIRMWARE UPGRADE

PANELS & REMOTE FUNCTIONS

TECHNICAL DATA

# TABLE OF CONTENTS

<b>1. PRECAUTIONS</b> .....	<b>3</b>
1.1 Important Remark .....	3
1.2 Important Safety Instructions .....	4
1.3 Cleaning.....	4
<b>2. PACKAGE CONTENTS</b> .....	<b>5</b>
<b>3. DESCRIPTION &amp; FEATURES</b> .....	<b>5</b>
3.1 Main Features .....	6
<b>4. INSTALL &amp; CONNECT</b> .....	<b>6</b>
<b>5. START-UP &amp; OPERATION</b> .....	<b>7</b>
5.1 LCD Display control menu.....	7
5.2 Video Switching Control .....	8
5.3 Output Signal Control .....	9
5.3.1 Output Video Control.....	9
5.3.2 Output Audio Control .....	10
5.4 Input Signal Control.....	12
5.4.1 EDID .....	12
5.5 Presets Configuration .....	13
5.6 Configuration .....	14
5.7 Info .....	17
5.8 Remote Controlling.....	17
5.8.1 Series Port Setting.....	18
5.8.2 Command List.....	18
<b>6. WebGUI</b> .....	<b>21</b>
6.1 Change IP address of PC .....	21
6.2 Login by Browser .....	22
6.3 Status .....	22
6.4 Input.....	23
6.5 Output.....	25
6.6 Matrix .....	26
6.7 Preset.....	27
6.8 Settings.....	28
<b>7. FIRMWARE UPGRADE</b> .....	<b>29</b>
<b>8. PANELS &amp; REMOTE FUNCTIONS</b> .....	<b>30</b>
8.1 Front Panel .....	30
o Rear Panel .....	31
8.2 Remote Control.....	32
<b>9. TECHNICAL DATA</b> .....	<b>34</b>
9.1 Technical Specifications .....	34
9.2 Mechanical Diagram .....	35

PRECAUTIONS
PACKAGE CONTENTS
DESCRIPTION & FEATURES
INSTALL & CONNECT
START-UP & OPERATION
WebGUI
FIRMWARE UPGRADE
PANELS & REMOTE FUNCTIONS
TECHNICAL DATA

# 1. PRECAUTIONS

## 1.1 Important Remark



**WARNING: SHOCK HAZARD - DO NOT OPEN**

**AVIS: RISQUE DE CHOC ÉLECTRIQUE - NE PAS OUVRIR**



The lightning flash with arrowhead symbol, within an equilateral triangle, is intended to alert the user to the presence of uninsulated “dangerous voltage” within the product’s enclosure that may be of sufficient magnitude to constitute a risk of electric shock to persons.



The exclamation point within an equilateral triangle is intended to alert the user to the presence of important operating and maintenance (servicing) instructions in the literature accompanying the appliance.

**WARNING (If applicable):** The terminals marked with symbol of “⚡” may be of sufficient magnitude to constitute a risk of electric shock. The external wiring connected to the terminals requires installation by an instructed person or the use of ready-made leads or cords.

**WARNING:** To prevent fire or shock hazard, do not expose this equipment to rain or moisture.

**WARNING:** A device with Class I construction shall be connected to a mains socket-outlet with a protective earthing connection.



**WARNING:** This product must not be discarded, under any circumstance, as unsorted urban waste. Take to the nearest electrical and electronic waste treatment centre.

**⚠ This equipment has been tested and found to comply with the limits for a Class A digital device, pursuant to part 15 of the FCC Rules.** These limits are designed to provide reasonable protection against harmful interference when the equipment is operated in a commercial environment. This equipment generates, uses, and can radiate radio frequency energy and, if not installed and used in accordance with the instruction manual, may cause harmful interference to radio communications. Operation of this equipment in a residential area is likely to cause harmful interference in which case the user will be required to correct the interference at his own expense.



PRECAUTIONS

PACKAGE CONTENTS

DESCRIPTION & FEATURES

INSTALL & CONNECT

START-UP & OPERATION

WebGUI

FIRMWARE UPGRADE

PANELS & REMOTE FUNCTIONS

TECHNICAL DATA

## 1.2 Important Safety Instructions

1. Read these instructions.
2. Keep these instructions.
3. Heed all warnings.
4. Follow all instructions.
5. Do not use this device near water.
6. Clean only with dry cloth.
7. Do not block any ventilation openings. Install in accordance with the manufacturer's instructions.
8. Do not install near any heat sources such as radiators, heat registers, stoves, or other device (including amplifiers) that produce heat.
9. Do not defeat the safety purpose of the polarized or grounding type plug. A polarized plug has two blades with one wider than the other. A grounding type plug has two blades and a third grounding prong. The wide blade or the third prong are provided for your safety. If the provided plug does not fit into your outlet, consult an electrician for replacement of the obsolete outlet.
10. Protect the power cord from being walked on or pinched particularly at the plugs, convenience receptacles, and at the point where they exit from the device.
11. Only use attachments/accessories specified by the manufacturer.
12. Unplug the device during lightening sorts or when unused for long periods of time.
13. Refer all servicing to qualified personnel. Servicing is required when the device has been damaged in any way, such as power supply cord or plug is damaged, liquid has been spilled or objects have fallen into the device, the device has been exposed to rain or moisture, does not operate normally, or has been dropped.
14. Disconnecting from mains: When switching off the POWER switch, all the functions and light indicators of the unit will be stopped, but fully disconnecting the device from mains is done by unplugging the power cable from the mains input socket. For this reason, it always shall remain easily accessible.
15. Equipment is connected to a socket-outlet with earthing connection by means of a power cord.
16. The marking information is located at the bottom of the unit.
17. The device shall not be exposed to dripping or splashing and that no objects filled with liquids, such as vases, shall be placed on device.

## 1.3 Cleaning



**Clean the unit with a soft, dry clean cloth** or slightly wet with water and neutral liquid soap only, then dry it with a clean cloth. Be careful that water never gets into the unit through any hole. Never use alcohol, benzine, solvents or abrasive substances to clean this unit.

**NEEC AUDIO BARCELONA, S.L.** accepts no liability for any damage that may be caused to people, animal, or objects due to failure to comply with the warnings above.



PRECAUTIONS

PACKAGE CONTENTS

DESCRIPTION & FEATURES

INSTALL & CONNECT

START-UP & OPERATION

WebGUI

FIRMWARE UPGRADE

PANELS & REMOTE FUNCTIONS

TECHNICAL DATA

**Thank you for choosing our device Ecler VEO-MXH44D!**  
**We appreciate your trust.**

It is **VERY IMPORTANT** to carefully read this manual and to fully understand its contents before any connection in order to maximize your use and get the best performance from this equipment.

To ensure optimal operation of this device, we strongly recommend that its maintenance be carried out by our authorised Technical Services.

**All ECLER products are covered by warranty**, please refer to [www.ecler.com](http://www.ecler.com) or the warranty card included with this product for the period of validity and conditions.

## 2. PACKAGE CONTENTS

- 1x VEO-MXH44D.
- 1x 12V/2A DC power supply.
- 1x Remote control.
- 1x IR Ext RX Cable.
- 5 x 3 pin Euroblock connector for RS-232 and audio extraction.
- First Steps Guide.
- Warranty card.

## 3. DESCRIPTION & FEATURES

**VEO-MXH44D** is a 4x4 HDMI® matrix that supports up to 4K/UHD video resolution at 60 Hz with 4:4:4 chroma sampling. It features 8 analogue and digital audio de-embedding outputs, along with EDID management, an LCD display, and an integrated web GUI, providing a user-friendly configuration and control interface.

HDMI® sources can be addressed using the selection buttons on the front panel or through serial commands, TCP/IP, and IR. The VEO-MXH44D is compliant with HDCP 2.2 and 1.4 standards.

Additionally, the VEO-MXH44D can load and launch up to 8 presets, making it a professional solution for applications that require routing of video and audio HDMI® signals between 4K/UHD sources and displays, with smart control management.



PRECAUTIONS

PACKAGE CONTENTS

DESCRIPTION & FEATURES

INSTALL & CONNECT

START-UP & OPERATION

WebGUI

FIRMWARE UPGRADE

PANELS & REMOTE FUNCTIONS

TECHNICAL DATA

### 3.1 Main Features

- It has 4 HDMI® inputs that can be independently routed to 4 HDMI® outputs.
- Supports HDMI® up to 4K @ 60Hz, YUV 4:4:4 8-bit, HDR (at 4K @ 60Hz YUV 4:2:0 10-bit).
- Supports Full HD video downscaling.
- Provides storage for 8 presets.
- Supports audio formats, including Dolby TrueHD, Dolby Atmos, DTS-HD Master Audio, and DTS:X transmissions.
- Allows analogue audio extraction via a stereo unbalanced Euroblock connector, as well as stereo and surround digital audio extraction via an S/PDIF coaxial connector.
- Control options including front panel and display, IR remote, RS-232 control, IP control, and WebGUI.
- Features advanced EDID management.
- Compliant with HDCP 2.2.
- Powered by a local 12V DC power supply.

## 4. INSTALL & CONNECT

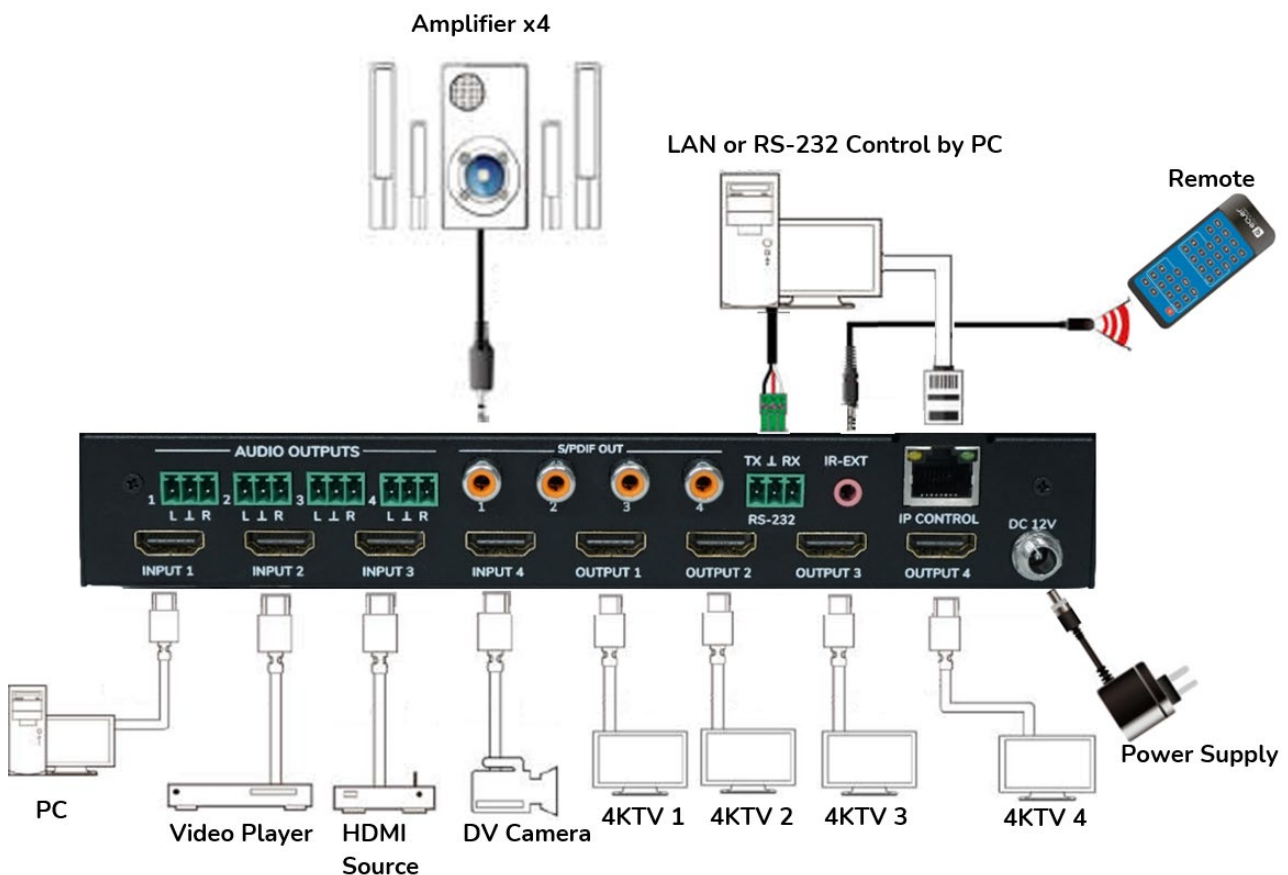

Home icon
PRECAUTIONS
PACKAGE CONTENTS
DESCRIPTION & FEATURES
INSTALL & CONNECT
START-UP & OPERATION
WebGUI
FW/FIRMWARE UPGRADE
PANELS & REMOTE FUNCTIONS
TECHNICAL DATA

## 5. START-UP & OPERATION

The unit can be controlled and configured by following the steps indicated below. In addition, if you prefer, it can also be configured by the [WebGUI](#).

### 5.1 LCD Display control menu

- To operate through the different menus, please use:

- **UP/DOWN** buttons of the front panel or ▲/▼ buttons of the Remote Control to select the item.
- **ENTER** button of the front panel to accept or ► button of the Remote Control. The selected item will be highlighted in white.
- **MENU** button of the front panel to go back or ◀ button of the Remote Control.

- **Display Information**

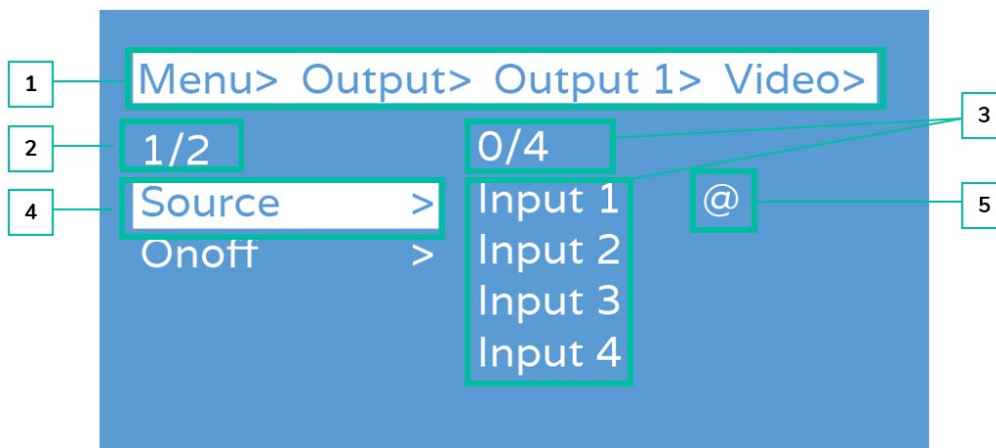

1. At the top of the screen, all the menus and submenus you have selected to reach the current screen are displayed. It is very useful to always know which menu you are in.
2. Numbers on the left side of the screen: the first digit indicates the current position of the selected item among the total available items for the selected menu. The second digit indicates the total available items for the selected menu.
3. Numbers on the right side of the screen: the first digit indicates the current position of the selected option among the total available options for the selected item. The second digit indicates the total available options available for the selected item.
4. Selected Menu or item will be highlighted in white.
5. The @ symbol appears next to the selected option value as a confirmation of the selection.

## 5.2 Video Switching Control

The signal switch includes 4 **free switching channels**, which **can be configured as input/output** according to the requirements, forming a matrix of  $1 \times 4 \sim 4 \times 1$ , which can switch any input signal to a single output or simultaneously to all outputs.

Output	1	2	3	4
Input	1	2	3	4

- **To switch input channel to the output**, select the "output channel" + "input channel", follow these steps:
  1. Press the desired input channel selection.
  2. Press the desired output channel that you want to associate with the selected "input channel".
- **To assign an input channel all output channels**, follow these steps:
  1. Long press any input channel for 2 seconds.



### Examples:

- Switch input 1 to output 4  
Operation: press input1 and then output4 to complete switch
- Switch input 4 to all outputs  
Operation: long press input 4 to complete the switch.
- All output switch to input 4  
Operation: long press any output and then long press input 4 to complete switch.



**If time between pressings exceeds 10s, it will be necessary to press output button again.**



PRECAUTIONS

PACKAGE CONTENTS

DESCRIPTION & FEATURES

INSTALL & CONNECT

START-UP & OPERATION

WebGUI

FIRMWARE UPGRADE

PANELS & REMOTE FUNCTIONS

TECHNICAL DATA



## 5.3 Output Signal Control

This section allows to **manage each of the 4 output signals**.

```
Menu>
1/5      0/5
Output > Output 1 >
Input   > Output 2 >
Preset  > Output 3 >
Config  > Output 4 >
Info    > All      >
```

```
Menu> Output>
1/2      1/2
Output 1 > Video  >
Output 2 > Audio  >
Output 3 >
Output 4 >
All      >
```

### 5.3.1 Output Video Control

This section allows you to **control the operation of the video features of each of the 4 output signals**.

```
Menu>
1/5      0/5
Output > Output 1 >
Input   > Output 2 >
Preset  > Output 3 >
Config  > Output 4 >
Info    > All      >
```

```
Menu> Output> Output 1>
1/2      1/2
Video   > Source  >
Audio   > Onoff   >
```

#### 5.3.1.1 Switching

**Switch any output to one input or switch all outputs to one input.** By default, 4x4 matrix, 4 inputs and 4 outputs, one to one output.

```
Menu> Output> Output 1>
1/2      1/2
Video   > Source  >
Audio   > Onoff   >
```

```
Menu> Output> Output 1> Video>
1/2      0/4
Source   > Input 1  @
Onoff   > Input 2
         Input 3
         Input 4
```

1. Select **“Output”** in the menu and press **“ENTER”**.
2. Then use **“UP/▲ or DOWN/▼”** button to **select “output 1~4” or “All”** (“All” means all outputs). The selected output will be highlighted in white.
3. Press **“ENTER”** enter next page.
4. Press **“UP/▲ or DOWN/▼”** button to select **“Video”**, press **“ENTER”**.
5. Press **“UP/▲ or DOWN/▼”** button to select **“Source”**, press **“ENTER”**.
6. Press **“UP/▲ or DOWN/▼”** button to select **“Input 1~4”**, press **“ENTER”**. Switch is done.

### 5.3.1.2 On/Off

Video signal can be switched on and off on any output selected. By default, the output video is set to be active.

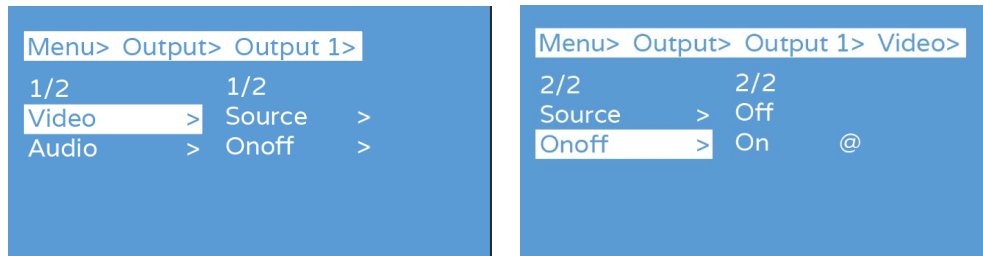

1. Select “**Output**” in the menu and press “**ENTER**”.
2. Then use “**UP/▲ or DOWN/▼**” button to select “**output 1~4**” or “**All**” (“All” means all outputs). The selected output will be highlighted in white.
3. Press “**ENTER**” enter next page.
4. Press “**UP/▲ or DOWN/▼**” button to select “**Video**”, press “**ENTER**”
5. Press “**UP/▲ or DOWN/▼**” button to select “**Onoff**”, press “**ENTER**”.
6. Finally, press “**UP/▲ or DOWN/▼**” button to choose “**On**” or “**Off**”, and press “**ENTER**” to confirm your choice.
7. The @ symbol appears next to the selected value as a confirmation of the selection.

### 5.3.2 Output Audio Control

This section allows to enable/disable the output audio of each one of the 4 signals.

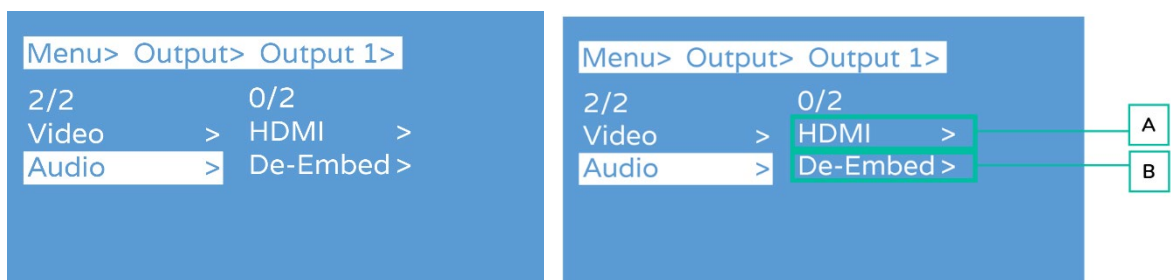

1. Select “**Output**” and press “**ENTER**”.
2. Press “**UP/▲ or DOWN/▼**” button to select “**Output1~4**” or “**All**” (“All” means all outputs). The selected output will be highlighted in white.
3. Press “**ENTER**”.
4. Press “**UP/▲ or DOWN/▼**” button to select “**Audio**”, press “**ENTER**”.
5. Press “**UP/▲ or DOWN/▼**” button to select the item you want to adjust.

PRECAUTIONS
PACKAGE CONTENTS
DESCRIPTION & FEATURES
INSTALL & CONNECT
START-UP & OPERATION
WebGUI
FIRMWARE UPGRADE
PANELS & REMOTE FUNCTIONS
TECHNICAL DATA

### A. HDMI audio support

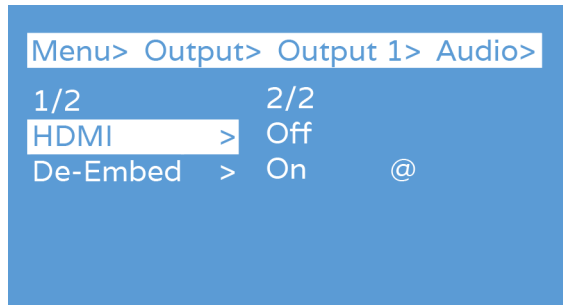

### B. De-Embed

This parameter allows to **turn on and off the audio extraction**.

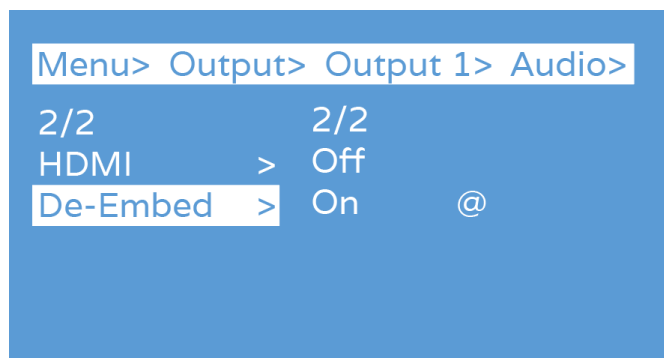

1. Select "**Audio**" from the main menu and press "**ENTER**".
2. Use the "**UP/▲ or DOWN/▼**" button to **choose "De-Embed"** and press "**ENTER**". The selected option will be highlighted in white.
3. Use the "**UP/▲ or DOWN/▼**" button to **select the desired output** (1-4 or All).
4. Press "**ENTER**" to **toggle between "On" and "Off"** for the selected output.

## 5.4 Input Signal Control

This section allows to **operate the features of each one of the 4 input signals**.

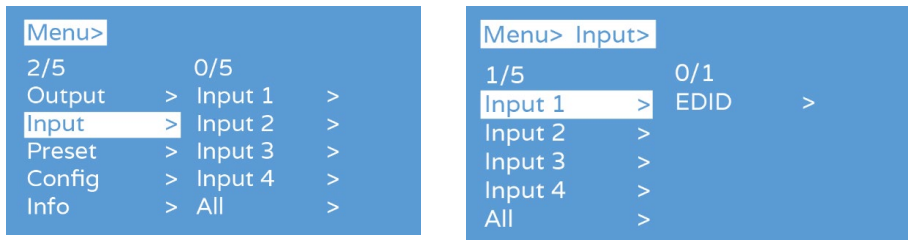

1. Select **“Input”** and press **“ENTER”**.
2. Press **“UP/▲ or DOWN/▼”** button to **select “Input1~4”** or **“All”** (“All” means all inputs). The selected input will be highlighted in white. Press **“ENTER”**.
3. Press **“UP/▲ or DOWN/▼”** button to select **“Video”**, press **“ENTER”**.
4. Press **“UP/▲ or DOWN/▼”** button to **select the item you want to adjust**.

### 5.4.1 EDID

This parameter allows to **manage EDID settings**.

- Default 1:** 4K@60Hz 444-LPCM: 2.0, HDR:HLG
- Default 2:** 4K@60Hz 420-LPCM: 2.0, HDR:None
- Default 3:** 4K@30Hz 444-LPCM: 2.0, HDR:None
- Default 4:** 1080p@60Hz 444-LPCM: 2.0, HDR:None



The **default EDID is “Default1”**.

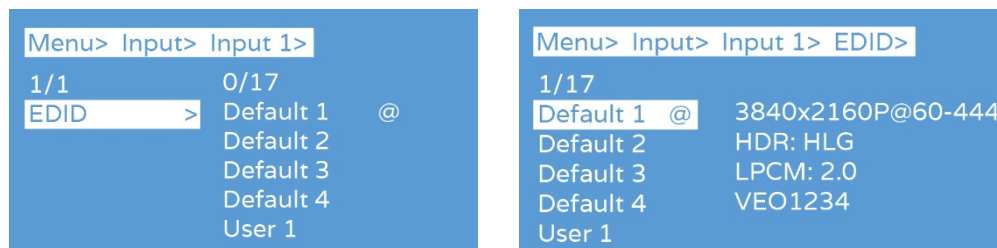

1. Press **“UP/▲ or DOWN/▼”** button to **adjust the selected item** according to your choice.
2. Press **“MENU”**, to **return to the previous menu**, and then press **“UP/▲ or DOWN/▼”** button to **select the other items**. Press **“ENTER”**.
3. Press **“UP/▲ or DOWN/▼”** button to adjust the selected item according to your choice.
4. The **@ symbol appears next to the selected value as a confirmation** of the selection and **EDID details (Name, Max resolution, audio format, soundtrack)** will appear next to the chosen option.

## 5.5 Presets Configuration

This section enables **to save the settings for Video, Audio, EDID, and System in 8 different presets to effectively manage and customize your own settings.**

Following actions can be performed for each preset:

- **Clear:** Delete a saved preset to free up the preset slot for future use.
- **Save:** Save the current state of video, audio, EDID, system settings, etc., as a preset. You can save up to 8 presets.
- **Call:** Recall a previously saved preset to restore the saved state of video, audio, EDID, system settings, etc.



Presets can be selected or changed by [Front Panel buttons](#) or by [WebGUI](#).



The **default preset is same as the factory setting (PTP).**

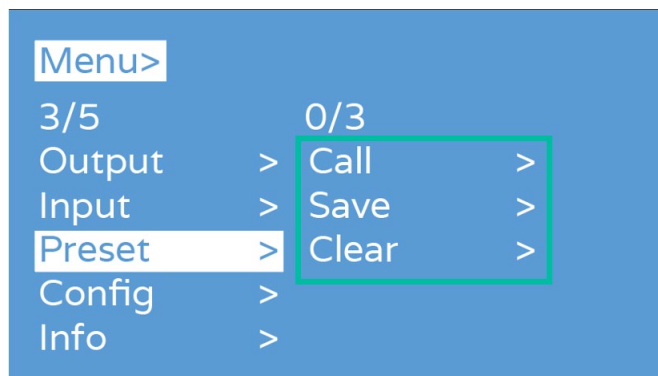

1. Select **"Preset"**, press **"ENTER"**, then select the preset **Scene** interface.
2. **To recall a preset**, choose "Call" and select the desired Preset1~8. Press "ENTER" to confirm.
3. **To save the current configuration as a preset**, select "Save" and choose one of the Preset1~8 options. Press "ENTER" to save.
4. **To clear a preset and restore it to the default settings**, select "Clear" and choose the desired Preset1~8. Press "ENTER" to confirm.



PRECAUTIONS

PACKAGE CONTENTS

DESCRIPTION & FEATURES

INSTALL & CONNECT

START-UP & OPERATION

WebGUI

FIRMWARE UPGRADE

PANELS & REMOTE FUNCTIONS

TECHNICAL DATA

## 5.6 Configuration

This section allows to **configure general settings**.

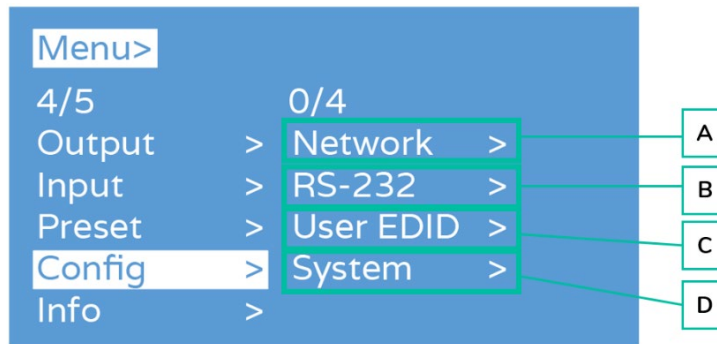

### A. Network (DHCP switch)

This section allows to **enable DHCP for network configuration**.

- **DHCP On:** dynamic IP address
- **DHCP Off:** static IP address (by default)

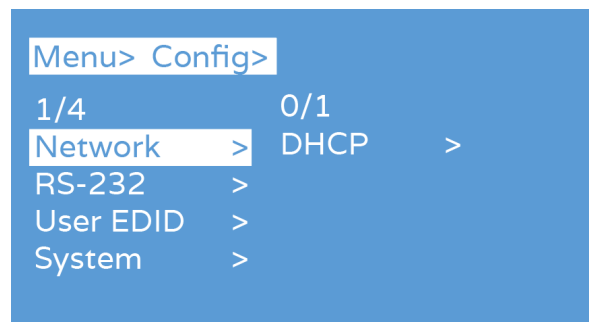

**To change the DHCP setting:**

1. Select **"Setup"** in main menu and press **"ENTER"** button.
2. Press **"UP/▲ or DOWN/▼"** button to select **"DHCP" setting**.
3. Press **"ENTER"** to enter the next sub-menu.
4. Press **"UP/▲ or DOWN/▼"** button to select **"On"**.
5. Press **"ENTER"** to open DHCP to allocate IP address automatically.

HOME
PRECAUTIONS
PACKAGE CONTENTS
DESCRIPTION & FEATURES
INSTALL & CONNECT
START-UP & OPERATION
WebGUI
FIRMWARE UPGRADE
PANELS & REMOTE FUNCTIONS
TECHNICAL DATA

## B. RS-232 (Baud rate)

This section allows to **adjust the serial baud rate**.

```
Menu> Config>
2/4          0/4
Network > 115200 @
RS-232 > 57600
User EDID > 19200
System > 9600
```

1. From the main menu, select **"Setup"** and **press "ENTER"**.
2. Press **"UP/▲ or DOWN/▼"** button to choose **"Baud"**.
3. Press **"ENTER"** to enter the sub-menu.
4. Press **"UP/▲ or DOWN/▼"** button to **select the desired baud rate**, such as **"9600"**.
5. Press **"ENTER"** to **confirm** and complete the setting.

## C. User EDID

Allows to **save default EDID, output EDID and temporary EDID** to the User EDID.

```
Menu> Config>
3/4          0/5
Network > user 1 >
RS-232 > user 2 >
User EDID > user 3 >
System > user 4 >
           All >
```

1. Select **"Config"**, press **"ENTER"**.
2. Press **"UP/▲ or DOWN/▼"** button to select **"User EDID"**, press **"ENTER"**.
3. Press **"UP/▲ or DOWN/▼"** button to **select "User1~4" or "ALL"**, press **"ENTER"**.
4. Press **"UP/▲ or DOWN/▼"** button to **select default EDID, output EDID or temporary EDID to save User EDID**, while you can check EDID information.
5. The **@ symbol appears next to the selected value as a confirmation** of the selection.

```
Menu> Config> User EDID>
1/5          1/13
user 1 > Default 1 @
user 2 > Default 2
user 3 > Default 3
user 4 > Default 4
All > Output 1
```

```
Menu> Config> User EDID> user 1>
1/13
Default 1 @ 3840x2160P@60-444
Default 2 HDR: HLG
Default 3 LPCM: 2.0
Default 4 VEO1234
Output 1
```

## D. System

Allows to set device's Reboot, Timing switch and Factory data reset.

```
Menu> Config>
4/4          0/2
Network    > Reboot    >
RS-232    > Factory   >
User EDID  >
System    >
```

1. Select “Config”, press “ENTER”.
2. Press “UP/▲ or DOWN/▼” button to select “System”, press “ENTER”.
3. Press “UP/▲ or DOWN/▼” button to select:
  - **Reboot:** select Yes or No.
  - **Factory:** there are two different options to restore factory defaults:
    - **Common:** factory reset for video switch, EDID, audio and setting (IP address can't be factory rest when under “common”).
    - **All:** factory set for video, EDID, audio, setting, preset and device name.

 **If you perform a factory reset, all user settings will be deleted and restored to the factory default settings.**

```
Menu> Config> System>
2/2          0/2
Reboot    > Common  >
Factory   > All    >
```

```
Menu> Config> System> Factory>
1/2          0/2
Common    > No    @
All       > Yes
```

```
...>> System> Factory> Common>
1/2
No    @    Reset information:
Yes
```

1. Video 2. Audio  
3. EDID 4. Setup

-  PRECAUTIONS
- PACKAGE CONTENTS
- DESCRIPTION & FEATURES
- INSTALL & CONNECT
- START-UP & OPERATION
- WebGUI
- FIRMWARE UPGRADE
- PANELS & REMOTE FUNCTIONS
- TECHNICAL DATA



## 5.7 Info

This section allows to consult device and IP system information.

- **Device:** company name, device name and version information
- **Network:** device IP address, MAC address and DHCP status.

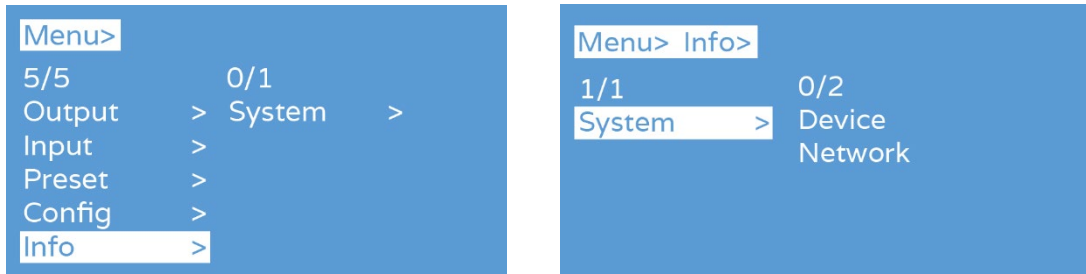

1. Select “INFO” in main menu and press “ENTER” button.
2. Press “UP/▲ or DOWN/▼” button to select “System” and press “ENTER” button.
3. Press the ‘UP/▲ or DOWN/▼’ button to select ‘Device’ or ‘Network’. The selected item will be highlighted in white when selected.
4. Press “ENTER” to enter the next sub-menu, to view the device information.

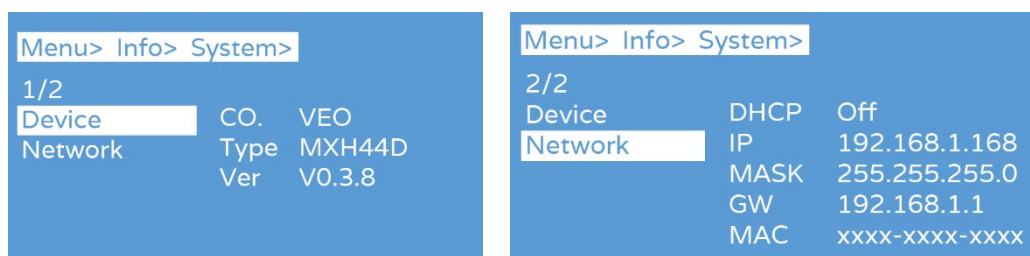

## 5.8 Remote Controlling

VEO-MXH44D can be remotely controlled over RS-232 or TCP/UDP communications protocol.

- For RS-232 serial communication: enter the selected parameters on [Series Port Setting chapter](#).
- For TCP/UDP communication: enter the current VEO-MXH44D IP address and Port: 5000 for TCP or 5001 for UDP commands.

### 5.8.1 Series Port Setting

The **serial parameters for a correct transmission** are:

Baud rate 115200 (by Default) | Data bits 8 | Stop bits 1 | Parity None | Flow control None

 **For a correct communication, both the host PC and VEO-MXH44D need to have the same baud rate amongst the available options.**

### 5.8.2 Command List

- 
- All commands start with “#”
  - “\_” the underline cannot be omitted.
  - Command head, Parameter and target need to add one “SPACE”.

Command Code	Description	Command Return
#video_d input=[x] output=[y]	Switches Video Input channel [x] to Output channel [y]  <b>PARAMETERS DESCRIPTION</b> <ul style="list-style-type: none"> <li>• [x]: Input channel number, ranging from 1 to 8. If [y]= output channel number</li> <li>• [y]= 0, all outputs</li> </ul>	<Output[x] : Video source> [Data=[y-1] : Input [y]]
#video_d output= [x] onoff=[y]	Turns on and off Output channel [x]  <b>PARAMETERS DESCRIPTION</b> <ul style="list-style-type: none"> <li>• [x]: Output channel number, ranging from 1 to 8. If [x]=0, all output</li> <li>• [y]: ON = 1 OFF = 0</li> </ul>	<Output[x] : Video OnOff> [Data=[y-1] : Input [y]]
#audio_d output=[x] dec=[y]	Enables or disables the De-embedded audio on a channel [x].  <b>PARAMETERS DESCRIPTION</b> <ul style="list-style-type: none"> <li>• [x]: Output channel number, ranging from 1 to 8. If [x]=0, all output</li> <li>• [y]: Enable or disable De-embedded audio ON = 1 OFF = 0</li> </ul>	<Output[x] : Audio De-Embed> [Data=[y-1] : Input [y]]
#audio_d output=[x] hdmi=[y]	Enable or disable HDMI® audio on channel [x]  <b>PARAMETER DESCRIPTION</b> <ul style="list-style-type: none"> <li>• [x]: Output channel number, from 1 to 8. If [x]=0, all outputs</li> <li>• [y]: enable or disable HDMI® ON = 1 OFF = 0</li> </ul>	<Output[x] : Audio HDMI> [Data=[y-1] : Input [y]]

<p><b>#audio_d output=[x] arc=[y]</b></p>	<p>Enable or disable ARC audio on channel [x]</p> <p><b>PARAMETER DESCRIPTION</b></p> <ul style="list-style-type: none"> <li>[x]: Output channel number, from 1 to 8. If [x]=0, all outputs</li> <li>[y]: enable or disable ARC ON = 1 OFF = 0</li> </ul>	<p>&lt;Output[x] : Audio ARC&gt; [Data=[y-1] : Input [y]]</p>
<p><b>#edid_d input=[x] mode=[y] data=[z]</b></p>	<p>Copy the EDID of the parameter ("mode [y]") to the selected input [x].</p> <p><b>PARAMETER DESCRIPTION</b></p> <ul style="list-style-type: none"> <li>[x]: Input channel number, from 1 to 8. If [x]=0, all inputs</li> <li>[y]: 0 = default mode 1 = user mode 2 = output mode 3 = input mode 4 = temp1 mode</li> <li>[z]: Selection number of the item to copy, from 1 to z.</li> </ul>	<p>&lt;Input[x] : EDID edid_sel&gt; [Data=[z] : mode[y]] &lt;Input[x] : EDID edid_sync1&gt; [Data=[z] : mode[y]]</p>
<p><b>#edid_d user=[x] mode=[y] data=[z]</b></p>	<p>Copy the EDID of the parameter ("mode [y]") to the selected user [x].</p> <p><b>PARAMETER DESCRIPTION</b></p> <ul style="list-style-type: none"> <li>[x]: User EDID number, <a href="#">see EDID management table</a>. If [x]=0, all user EDIDs</li> <li>[y]: 0 = default mode 1 = user mode 2 = output mode 3 = input mode 4 = temp1 mode</li> <li>[z]: Selection number of the item to copy, from 1 to z.</li> </ul>	<p>&lt;User[x] : EDID copy&gt; [Data=[z] : mode[y]]</p>
<p><b>#preset scene[x] exe=[y]</b></p>	<p>Saves, calls or clears a preset</p> <p><b>PARAMETERS DESCRIPTION</b></p> <ul style="list-style-type: none"> <li>[x]: Preset number, ranging from 1 to 8.</li> <li>[y]: saves, calls or clears Saves = 1 Calls = 0 Clears = 2</li> </ul>	<p>Preset: Preset[x] Save / Calls / Clears</p>
<p><b>#lcd bl_time=[x]</b></p>	<p>Specify the time the LCD screen is on</p> <p><b>PARAMETERS DESCRIPTION</b></p> <p>[x]: 0-254 = Time to turn off. 255 = LCD screen always on</p>	<p>New LCD bl wait : [x]</p>
<p><b>#lcd bl_lv=[x]</b></p>	<p>Increases or decreases LCD display backlight</p> <p><b>PARAMETERS DESCRIPTION</b></p> <ul style="list-style-type: none"> <li>[x]: backlight level, ranging from 0 to 10</li> </ul>	<p>New LCD bl lv: [x]</p>

PRECAUTIONS
PACKAGE CONTENTS
DESCRIPTION & FEATURES
INSTALL & CONNECT
START-UP & OPERATION
WebGUI
FIRMWARE UPGRADE
PANELS & REMOTE FUNCTIONS
TECHNICAL DATA

#lcd home_time=: [x]	<p>Increase or decrease the return time to the main menu of the LCD screen</p> <p><b>PARAMETERS DESCRIPTION</b> [x]:</p> <ul style="list-style-type: none"> <li>• 0-254 = Return time to the main menu</li> <li>• 255 = always fixed in the part of the menu that has been selected</li> </ul>	New LCD home wait: [x]
#lock onoff=[x]	<p>Lock or unlocks front panel buttons</p> <p><b>PARAMETERS DESCRIPTION</b> [x]:</p> <ul style="list-style-type: none"> <li>• ON = 1</li> <li>• OFF = 0</li> </ul>	front panel Lock: [x]
#factory:[x]	<p>Performs a factory reset</p> <p><b>PARAMETERS DESCRIPTION</b> [x]:</p> <ul style="list-style-type: none"> <li>• Operation data = 0</li> <li>• All settings = 1</li> </ul>	System reboot...

### Execution Examples:

- #video\_d input=1 output=2 -> Switches input 1 with output 2.
- #edid\_d input=1 mode=1 data=2 -> Input 1 copies the EDID from User 2.
- #edid\_d user=2 mode=0 data=1 -> User 2 copies their EDID from Default 1.



PRECAUTIONS

PACKAGE CONTENTS

DESCRIPTION & FEATURES

INSTALL & CONNECT

START-UP & OPERATION

WebGUI

FIRMWARE UPGRADE

PANELS & REMOTE FUNCTIONS

TECHNICAL DATA

## 6. WebGUI

The unit can be **controlled and configured by its own built-in web interface** by simply typing the **IP address of the chosen device** into a web browser.

### 6.1 Change IP address of PC

**! Before configuring the device through the website, it is necessary to configure the IP address of your computer to be in the same network segment as the device.**

1. Open the Network Control Center on your computer.
2. Find the network connection you are using (Ethernet or Wi-Fi).
3. Right-click on the network connection and select "Properties".
4. Look for "Internet Protocol Version 4 (TCP/IPv4)" or "IPv4" and select it.
5. Choose the option to manually set the IP address.
6. Enter an IP address that is in the same network segment as the device.
7. Set the subnet mask to match the device's network configuration.
8. Leave the default gateway field blank or enter the device's IP address.
9. Save the changes and close the network properties window.

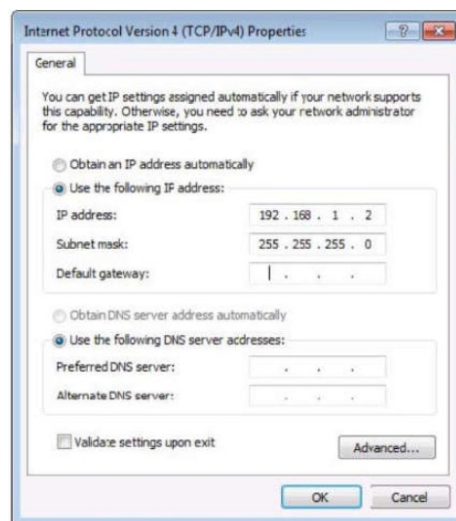

PRECAUTIONS

PACKAGE CONTENTS

DESCRIPTION & FEATURES

INSTALL & CONNECT

START-UP & OPERATION

WebGUI

FIRMWARE UPGRADE

PANELS & REMOTE FUNCTIONS

TECHNICAL DATA

## 6.2 Login by Browser

To access VEO-MXH44D WEB settings, it is necessary to enter the base unit IP address in an internet browser.

- **Default IP address:** 192.168.1.168
- **Default username:** admin
- **Default password:** admin



## 6.3 Status

This section allows to **check the status of several device settings**.

- **Input info:** Displays the status and information of the current device input port, Includes the connection status, input resolution, gamut colour depth, HDCP version information and input audio format of each input port.
- **Output EDID info:** Displays the status and information about the output port, Includes the connection status, output resolution and colour gamut, output audio format, EDID manufacturer of each output port.
- **Device info:** Displays the current name of the device, MCU and HTML of version number (Same as on the screen).

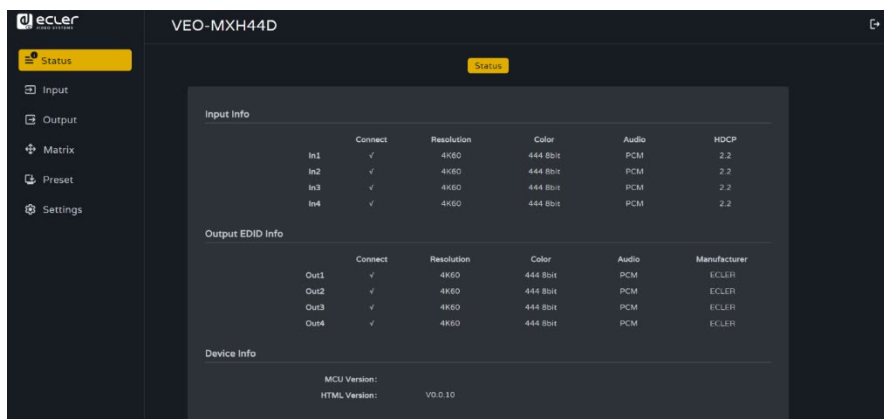

“✓” means open or normally connected, “x” means that it is closed or not connected.



PRECAUTIONS

PACKAGE CONTENTS

DESCRIPTION & FEATURES

INSTALL & CONNECT

START-UP & OPERATION

WebGUI

FIRMWARE UPDATE

PANELS & REMOTE FUNCTIONS

TECHNICAL DATA

## 6.4 Input

This section allows to **rename input ports**, **switching video signals** (opened by default), **switching audio input**, **selecting EDID**, and **switching audio source signals**.

- **Rename:** Modify the current name of input port, support 1~15 characters (numbers, letters and underscores) which is synchronized with the screen.
- **Apply:** Applies the name changes.
- **Copy EDID from:** Set default, copy, user EDID and display EDID information (HDR, audio channel, resolution, colour range).
- **User EDID:** Save default/copy EDID to User EDID and upgrade the BIN file to the User EDID.
- **All:** select all input ports to realize fast switch.

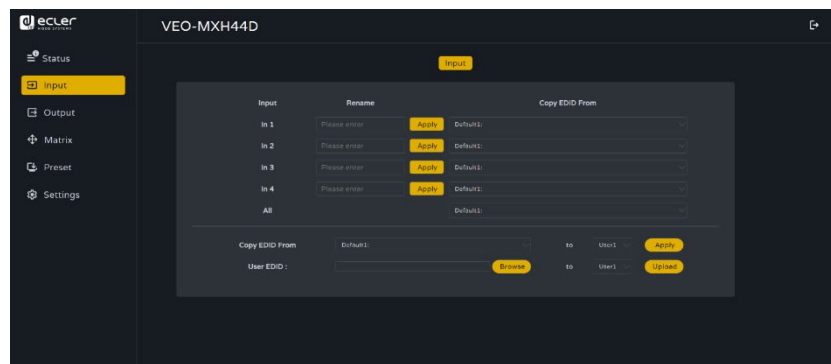

To operate each item:

1. **Rename:** Double click the left mouse button to enter the name editing to customize the name. Press "Apply" to confirm.
2. **Copy EDID from:** Use the mouse to click the white dropdown to complete the corresponding EDID switch. The dropdown will show the current EDID information.

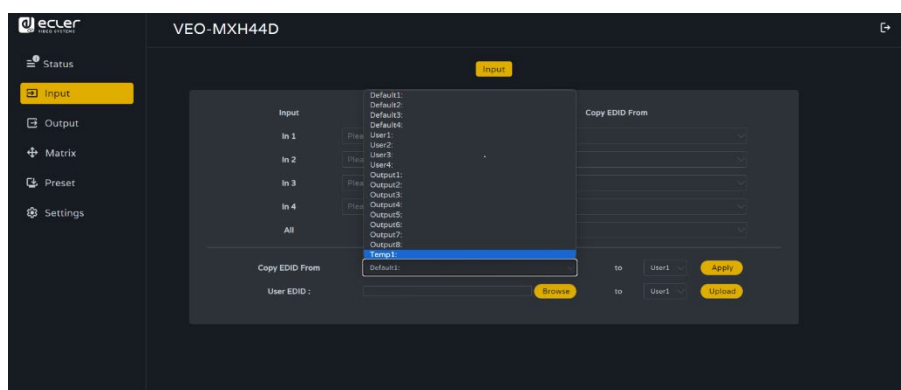

PRECAUTIONS

PACKAGE CONTENTS

DESCRIPTION & FEATURES

INSTALL & CONNECT

START-UP & OPERATION

WebGUI

FRMWARE UPGRADE

PANELS & REMOTE FUNCTIONS

TECHNICAL DATA

### 3. User EDID selection:

- Click the whitebox, select EDID, then select user1 ~ 4 in the box, and finally click apply.
- Click browse and select the path where the bin file is located, then select user1 ~ 4 in the box and finally click Upload. The EDID can be imported into user EDID.

- **EDID Management**

The device includes **4 EDID modes**: Default EDID, User EDID, Output EDID, Temp1, control EDID by WEB and RS-232. Factory Default: Default1 4K60 444 2CH.

[Refer to the EDID management commands in the table below.](#)

 **Instructions are as follows:**

**Send instruction:** “#edid\_d input=1 mode=1 data=2”. The input parameter “input” must be 0 or 1~8 (0 means all inputs), data =0~24 (corresponds to the following table).

EDID MODE	EDID Index	EDID
Default EDID	0	4096x2160@60-444 HLG 2CH (default)
	1	4096x2160@60-420 HLG 2CH
	2	4096x2160@30-444 HLG 2CH
	3	1920x1080P@120-444 HLG 2CH
User EDID	4-7	User EDID is set by user, with power-off memory function, new EDID will auto-cover old EDID.
Output EDID	8-15	Copy output 1-8 ports' EDID with storage function. without power-off memory
Temp1	24	Temporary EDID

 **4K resolution EDID configurations will automatically apply a downscaling when the target device does not support a resolution higher than 1080p**



## 6.5 Output

This section allows to **port renaming**, **switching output video** (on by default), **switching audio output** (HDMI®/Analog/SPDIF), **ARC function** (off by default).

- **Rename:** Modify the current name of output port, support 1~15 characters (numbers, letters and underscores).
- **Apply:** Applies the name changes.
- **Video:** Enable or disable the output video. It is independent of the audio extraction function.
- **Audio-HDMI:** Enable or disable HDMI® output audio.
- **De-Embed:** Enables or disables the audio extraction function, it will also disable SPDIF and analogue audio at the same time.

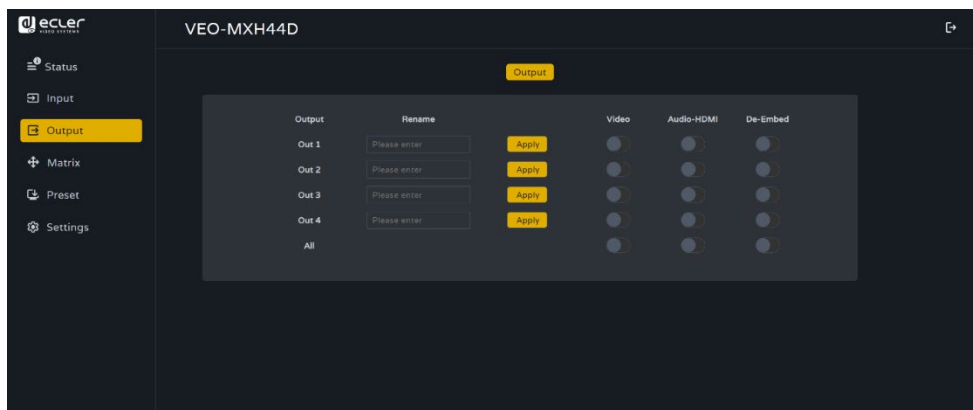

In **yellow** means on and **grey** means off.



PRECAUTIONS

PACKAGE CONTENTS

DESCRIPTION & FEATURES

INSTALL & CONNECT

START-UP & OPERATION

WebGUI

FRMWARE UPGRADE

PANELS & REMOTE FUNCTIONS

TECHNICAL DATA

## 6.6 Matrix

This section allows to **display the input source** corresponding to the current output port, **Switching the input to an output port and output the image.**

 The vertical axis indicates the selection of the input port, the horizontal axis indicates the selection of the output port, and “All” indicates the selection of all outputs.

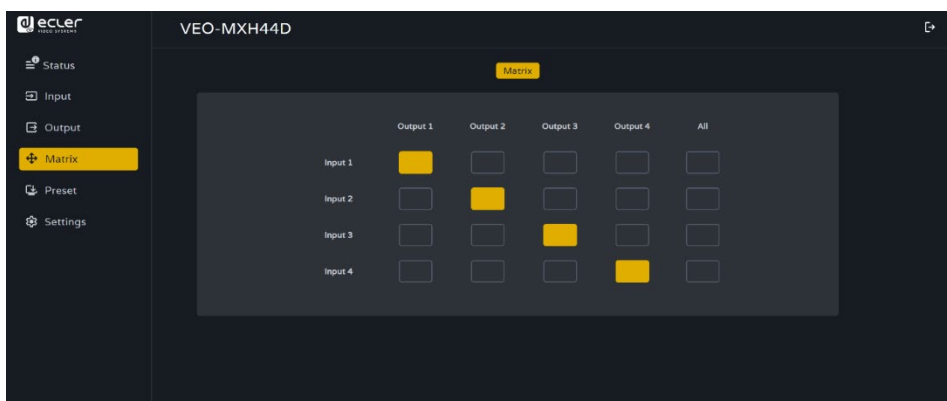

Click the input box to switch the corresponding output port.



PRECAUTIONS

PACKAGE CONTENTS

DESCRIPTION & FEATURES

INSTALL & CONNECT

START-UP & OPERATION

WebGUI

FRMWARE UPGRADE

PANELS & REMOTE FUNCTIONS

TECHNICAL DATA

## 6.7 Preset

Use this option to **rename, saving, calling, and clearing** of preset scene.



The device can preset 8 scenes and support scene renaming.

- **Clear** means clears the current saved scene.
- **Save** means save the current changed scene, the video, audio and system settings can be saved, but network parameter cannot be saved.
- **Call** means call the changed scene.

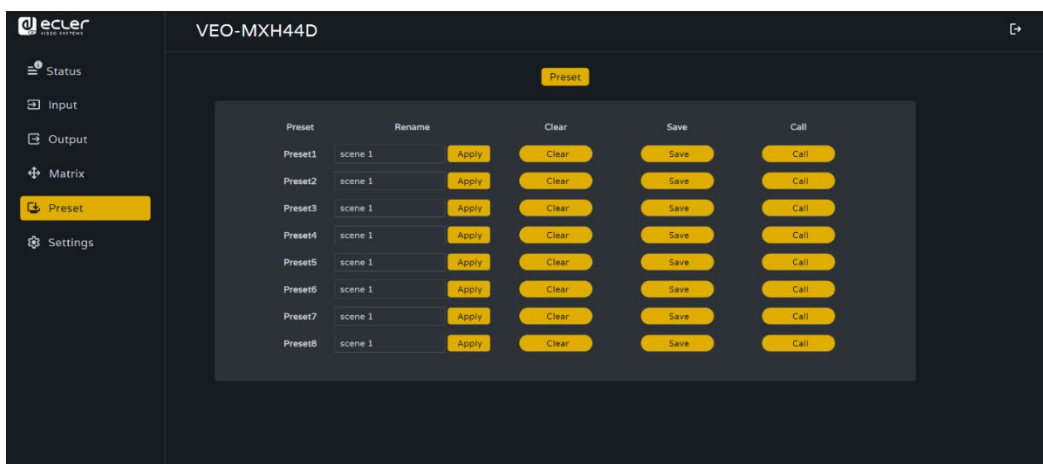

1. **Double click** on the left mouse button “**Preset1**”, click “**Apply**” to successfully rename the preset.
2. Click on “**Clear**” to delete the scenario.
3. Click on “**Save**”, to save the current scenario.
4. Click on “**Call**”, to recall the saved scenario.



PRECAUTIONS

PACKAGE CONTENTS

DESCRIPTION & FEATURES

INSTALL & CONNECT

START-UP & OPERATION

WebGUI

FRMWARE UPGRADE

PANELS & REMOTE FUNCTIONS

TECHNICAL DATA

## 6.8 Settings

This section allows to **modify and show network parameters and control protocol parameters TCP/UDP**, modify **web login account and password**, **reboot device**, general **restore factory**, user **restore factory**.

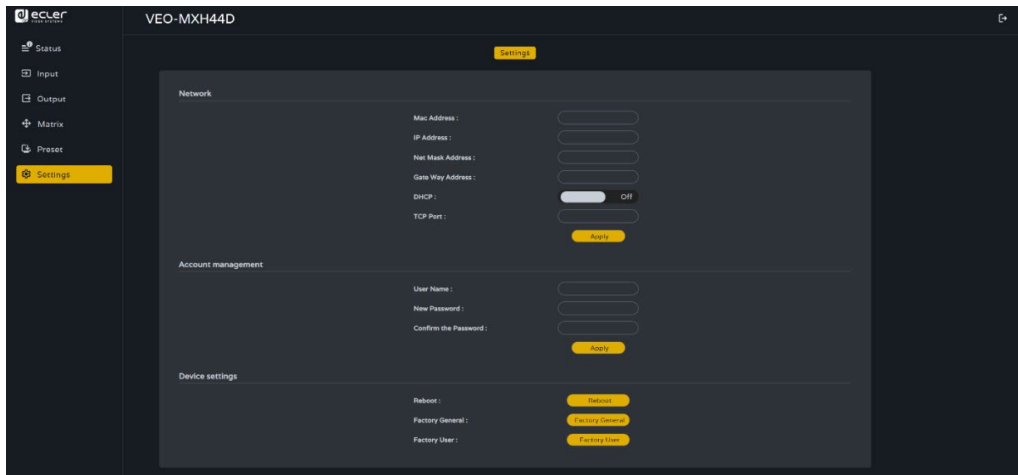

- **Mac address** can only be displayed. It cannot be modified.
- **IP address** is 192.168.1.168 by default. It can be modified.
  - After DHCP is opened, dynamic IP is used. In this case, the IP address cannot be modified and can assign by router.
  - After DHCP is off, static IP is used. In this case, the IP address can be modified. After the modification, click Apply.
- **Net Mask and Gateway address** can be modified, but the prerequisites are same as the IP address.
- **DHCP** use two-way button as switch, click directly to open DHCP (Green button means open DHCP and Gray means close DHCP).
- **TCP port:** Configure port (5000 by default) to access VEO-MXH44D.
- **UDP Port:** Configure the port (5001 by default) to access VEO-MXH44D.
- **Account management:** enter your account and password in the white box, Click Apply. It takes effect on next login, support 1~15 characters (numbers, letters, and underscores).
- **Click Reboot / Factory General / Factory User**, click enter according to your desired option.



PRECAUTIONS

PACKAGE CONTENTS

DESCRIPTION & FEATURES

INSTALL & CONNECT

START-UP & OPERATION

WebGUI

FIRMWARE UPGRADE

PANELS & REMOTE FUNCTIONS

TECHNICAL DATA

## 7. FIRMWARE UPGRADE

To update the MCU and web page using the updating software, follow these steps:

1. Connect your PC and the device using the RS-232 cable.
2. Open the updating software on your PC.
3. Click on the "Refresh" button to refresh the serial port list and select the correct serial port number for the device.
4. The default baud rate is 115200. Make sure the baud rate setting matches the device.
5. On the software, input "A1" in the port input field to initiate the MCU (BIN).upgrade process.
6. Select the path where the MCU upgrade program resides and follow the on-screen instructions to proceed with the upgrade.
7. After the MCU upgrade is completed, input "F0" in the port input field to initiate the web page (HTML).upgrade process.
8. Select the path where the web page upgrade program resides and follow the on-screen instructions to proceed with the upgrade.
9. Click on the "Update" button to start the update process.
10. Wait for the update process to complete. The information bar will display "Success" once the update is successful.

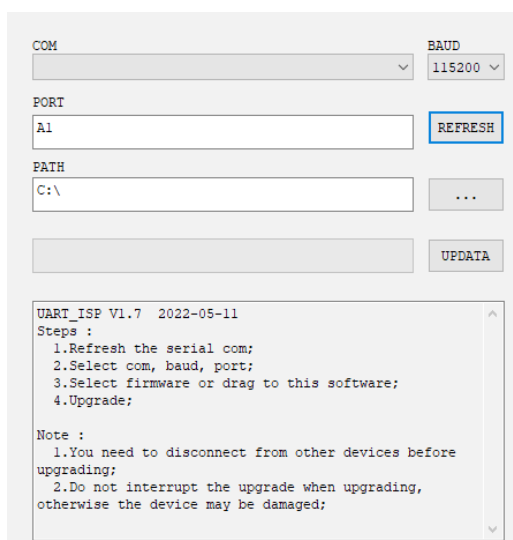

COM: [Dropdown] BAUD: 115200 [Dropdown]

PORT: A1 [Text] REFRESH [Button]

PATH: C:\ [Text] ... [Button]

UPDATE [Button]

```

UART_ISP V1.7 2022-05-11
Steps :
1.Refresh the serial com;
2.Select com, baud, port;
3.Select firmware or drag to this software;
4.Upgrade;

Note :
1.You need to disconnect from other devices before upgrading;
2.Do not interrupt the upgrade when upgrading, otherwise the device may be damaged;
    
```

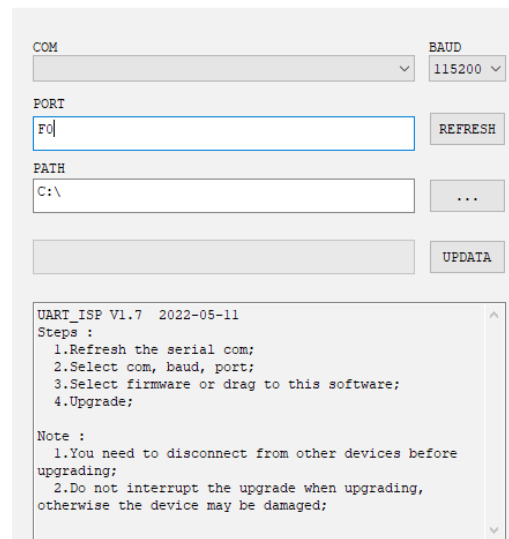

COM: [Dropdown] BAUD: 115200 [Dropdown]

PORT: F0 [Text] REFRESH [Button]

PATH: C:\ [Text] ... [Button]

UPDATE [Button]

```

UART_ISP V1.7 2022-05-11
Steps :
1.Refresh the serial com;
2.Select com, baud, port;
3.Select firmware or drag to this software;
4.Upgrade;

Note :
1.You need to disconnect from other devices before upgrading;
2.Do not interrupt the upgrade when upgrading, otherwise the device may be damaged;
    
```



PRECAUTIONS

PACKAGE CONTENTS

DESCRIPTION & FEATURES

INSTALL & CONNECT

START-UP & OPERATION

WebGUI

FIRMWARE UPGRADE

PANELS & REMOTE FUNCTIONS

TECHNICAL DATA

## 8. PANELS & REMOTE FUNCTIONS

### 8.1 Front Panel

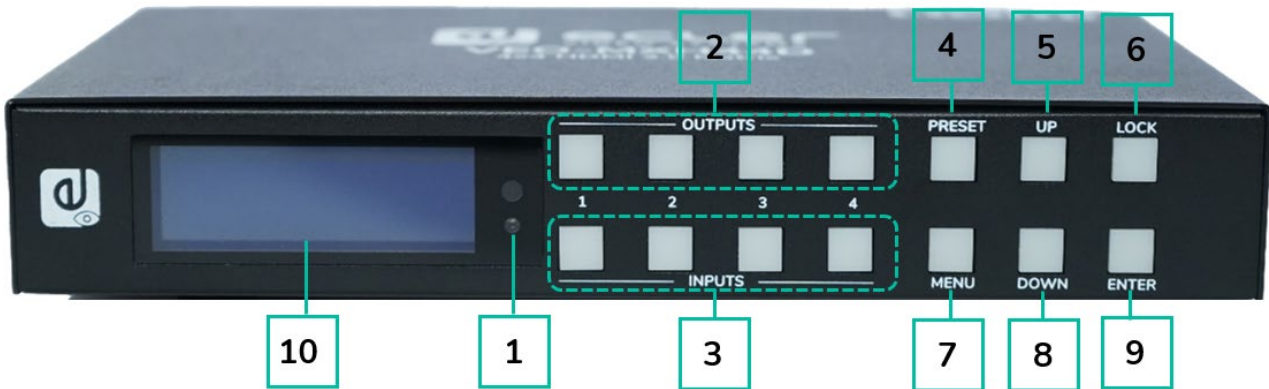

**1. IR receiver window.**

**2. Output 1-4:**

- short press to choose one output, press again to cancel.
- long press to choose all output, long press again to cancel.

**3. Input 1-4:**

- short press to choose one input (workable only if choose the output already).
- long press to choose one input for all output.

**4. PRESET:** short press to preset.

**5. UP:** short press to up.

**6. LOCK:** long press to lock, long press again to unlock ; when lock, all button is unworkable except for lock button.

**7. MENU:** press to main menu interface or return to the previous menu interface.

**8. DOWN:** short press to down.

**9. ENTER:** short press to confirm.

**10. LCD screen**



PRECAUTIONS

PACKAGE CONTENTS

DESCRIPTION & FEATURES

INSTALL & CONNECT

START-UP & OPERATION

WebGUI

FIRMWARE UPGRADE

PANELS & REMOTE FUNCTIONS

TECHNICAL DATA

o Rear Panel

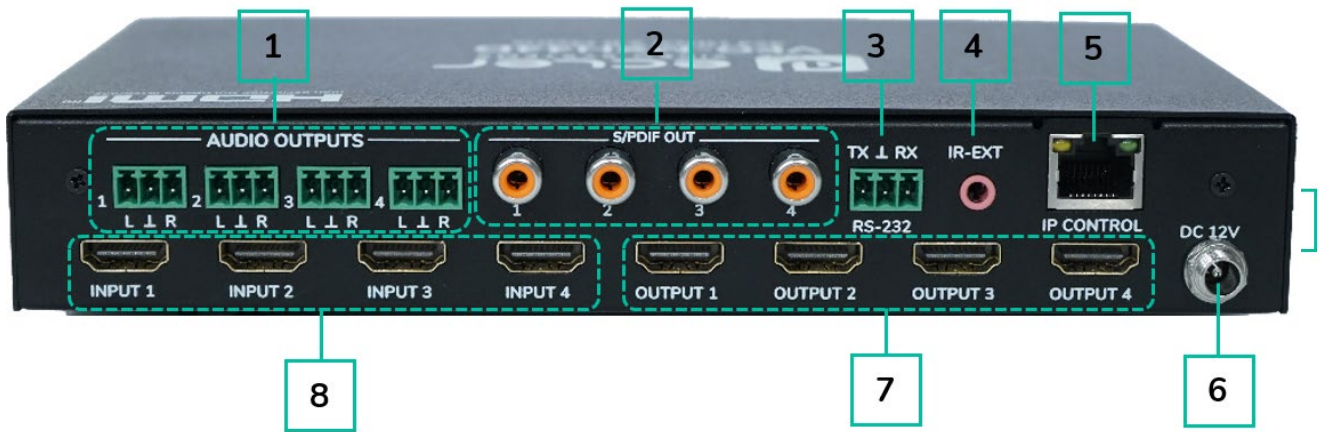

- |                       |                      |
|-----------------------|----------------------|
| 1. Analogue audio out | 5. Ethernet port     |
| 2. S/PDIF audio out   | 6. DC12V/2A input    |
| 3. RS-232 control     | 7. HDMI® output port |
| 4. IR-Ext             | 8. HDMI® input port  |



PRECAUTIONS

PACKAGE CONTENTS

DESCRIPTION & FEATURES

INSTALL & CONNECT

START-UP & OPERATION

WebGUI

FRMWARE UPGRADE

PANELS & REMOTE FUNCTIONS

TECHNICAL DATA

## 8.2 Remote Control

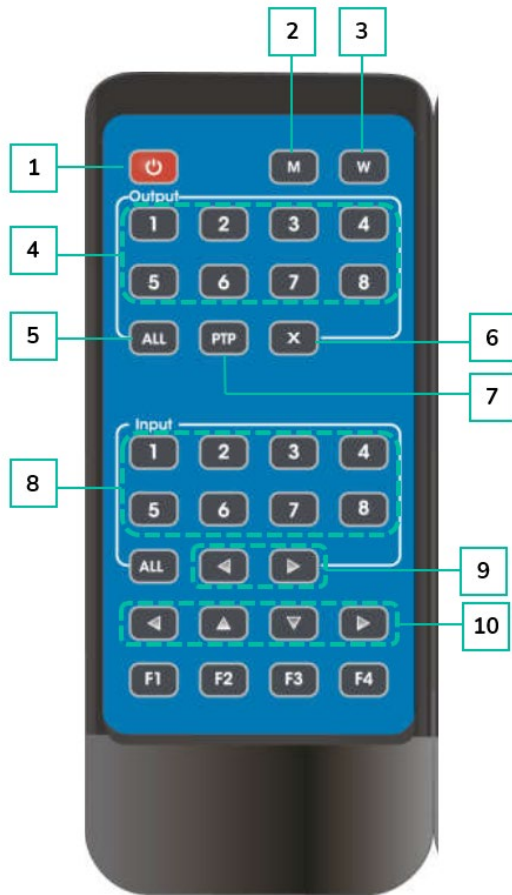

1. **Power on / Standby**
2. **M:** Turn off the HDMI® output audio
3. **W:** Lock or Unlock panel buttons.
4. **Output 1-8**
5. All **outputs** select INPUT-Y:
  - Press ALL button
  - Press INPUT-Y button (Y means 1 to 4 of the inputs).
6. **X:** Turn off output channel.
7. **PTP:** Mirror all inputs and outputs (Ex. Input 1 to output 1, input 2 to output 2, etc)
8. **Input 1-8**
9. **Switching input left and right**
10. **Up and down, left, and right.**

- **Power on/standby:**

- Short press the power button to enter standby mode. The LCD screen will display "System Shutdown", and the HDMI® output will be disconnected, resulting in no image on the TV.
- Short press the power button again to wake up the device. The HDMI® output will be restored to normal.

- **Video switch:**

- To switch the video signal from one input to a specific output, press the corresponding output button followed by the input button.
- For example, to switch the signal from input 2 to output 1, press output 1 button followed by input 2 button.



PRECAUTIONS

PACKAGE CONTENTS

DESCRIPTION & FEATURES

INSTALL & CONNECT

START-UP & OPERATION

WebGUI

FIRMWARE UPGRADE

PANELS & REMOTE FUNCTIONS

TECHNICAL DATA



- **Turn off HDMI® output audio:**
  - To mute the audio for a specific output, press the corresponding output button followed by the "M" button.
  - For example, to turn off the audio for output 1, press output 1 button followed by the "M" button.
- **Lock remote control:**
  - To lock the remote control, press the "W" button. This will prevent any further input from the remote control.
  - To unlock the remote control, short press the "W" button again.
- **Turn off output channel:**
  - To turn off a specific output channel, press the corresponding output button followed by the "X" button.
  - For example, to turn off output 1, press output 1 button followed by the "X" button. This will result in a black screen for output 1.
  - To return the output channel to normal, press the corresponding output button followed by the "X" button again.
- **Switching input left and right:**
  - To switch between inputs in a left or right direction, press the "All" button followed by the ◀ or ▶ button.
  - This will change the TV image according to the switching input. If there is no input signal, it will automatically skip to the next available input

PRECAUTIONS
PACKAGE CONTENTS
DESCRIPTION & FEATURES
INSTALL & CONNECT
START-UP & OPERATION
WebGUI
FRIMWARE UPGRADE
PANELS & REMOTE FUNCTIONS
TECHNICAL DATA

## 9. TECHNICAL DATA

### 9.1 Technical Specifications

#### VEO-MXH44D

Video Performances	
Video Input Connectors	4 x HDMI ®Type A Female, 18 Gbps
Video Output connectors	4 x HDMI ®Type A Female, 18 Gbps
Video Input Resolution	480p@60hz, 576p@50hz, 720p@60hz, 1080p@24hz, 1080p@50hz, 1080p@60hz, 4K@24hz, 4K@30hz, 4K@60hz YUV4:2:0, 4K@ 60hz YUV4:4:4
Video Output Resolution	480p@60hz, 576p@50hz, 720p@60hz, 1080p@24hz, 1080p@50hz, 1080p@60hz, 4K@24hz, 4K@30hz, 4K@60hz YUV4:2:0, 4K@ 60hz YUV4:4:4
Chroma Subsampling	YUV 4:4:4, YUV 4:2:0 (4K @ 60Hz)
Colour Depth	8-bit, 10-bit, 12-bit
Colour Space	RGB, YUV
HDCP	2.2
HDR	HDR10, Dolby Vision, HLG
HDMI Distance	10m with Ecler VEO Cables (up to 1080p) 5m with Ecler VEO Cables (up to 4K)
Audio Performances	
Audio Output Connectors	4 x 3 pin Euroblock connector, 4 x Coaxial Digital Out connector
Audio Formats	PCM2.0, PCM5.1, PCM7.1, Dolby Digital, DTS 5.1, Dolby Digital+ Dolby True HD, DTS-HD master audio, Dolby Atmos, DTS-X
Sample Rate	Up to 192KHz
Audio De-Embedding	Yes
Device Control	
Control Connectors	Euroblock, RJ-45, IR 3,5mm stereo jack
Control Protocols	Web, Telnet, RS-232, IR, Front panel Buttons and LCD Display
Control Buttons	1 x Enter, 1 x Lock, 1 x Up, 1 x Down, 1 x Preset Selection, 1 x Menu, 4 x Input Selection, 4 x Output Selection, Remote control
EDID Management	Software, Front Panel Buttons
Status Indicators	Input LED, LCD Display
Network	
Network Connectors	1 x RJ-45
Electrical	
Power Supply	External Power supply
AC Mains Connector	100-240VAC 50-60Hz with EU, UK, US, AU blades
DC Mains Connector	12VDC-2A with coaxial DC connector
Power Consumption	14W



PRECAUTIONS

PACKAGE CONTENTS

DESCRIPTION & FEATURES

INSTALL & CONNECT

START-UP & OPERATION

WebGUI

FIRMWARE UPGRADE

PANELS & REMOTE FUNCTIONS

TECHNICAL DATA

Physical

Operating Temperature	Min: 0°C; 32°F Max: 40°C; 104°F
Operating Humidity	<90% HR
Installation Options	Desktop
Included Accessories	5 x 3 pin Euroblock connector, 1 x Remote Control, 1 x IR receiver, 1x 12V PSU
Dimensions (WxHxD)	217.4 x 35 x 128.7 mm. / 8.56 x 1.38 x 5.07 in.
Shipping Dimensions (WxHxD)	310 x 85 x 264 mm / 12.20 x 3.35 x 10.39 in.
Weight	0,47 Kg / 1,04 lb
Shipping Weight	1.4 kg. / 3.09 lb
Chassis Material	Metal
Finished Colour	Black

9.2 Mechanical Diagram

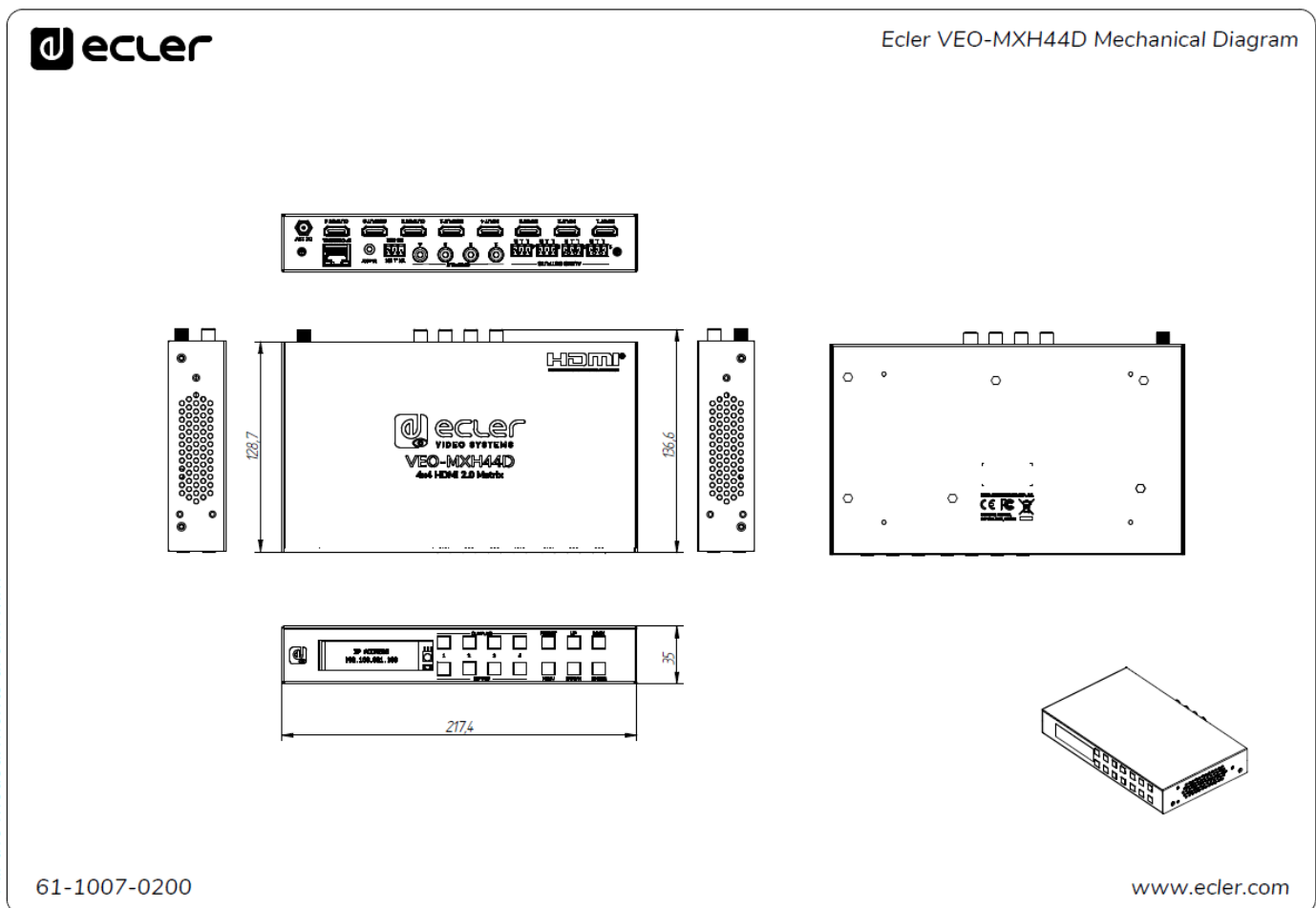

All the measurements are in mm

- PRECAUTIONS
- PACKAGE CONTENTS
- DESCRIPTION & FEATURES
- INSTALL & CONNECT
- START-UP & OPERATION
- WebGUI
- FIRMWARE UPGRADE
- PANELS & REMOTE FUNCTIONS
- TECHNICAL DATA



PRECAUTIONS

PACKAGE  
CONTENTS

DESCRIPTION  
&  
FEATURES

INSTALL  
&  
CONNECT

START-UP  
&  
OPERATION

WebGUI

FRMWARE  
UPGRADE

PANELS & REMOTE  
FUNCTIONS

TECHNICAL  
DATA



All product characteristics are subject to variation due to production tolerances. **NEEC AUDIO BARCELONA S.L.** reserves the right to make changes or improvements in the design or manufacturing that may affect these product specifications.

For technical queries contact your supplier, distributor or complete the contact form on our website, in [Support / Technical requests](#).

Motors, 166-168 | 08038 Barcelona, Spain | (+34) 932238403 | [information@ecler.com](mailto:information@ecler.com) | [www.ecler.com](http://www.ecler.com)