

VEO-XCTRLG2

VIDEO DISTRIBUTION OVER IP
H.265 Full HD over IP Video Extender Controller



PRECAUTIONS
PACKAGE CONTENTS
DESCRIPTION & FEATURES
INSTALL & CONNECT
START-UP & OPERATION
PANEL FUNCTIONS
TECHNICAL DATA

USER MANUAL

TABLE OF CONTENTS

1. PRECAUTIONS	3
1.1 Important Remark	3
1.2 Important Safety Instructions.....	4
1.3 Cleaning	4
2. PACKAGE CONTENTS	5
3. DESCRIPTION AND FEATURES	5
3.1 Main Features.....	6
4. INSTALL & CONNECT.....	7
4.1 Connection Diagram	7
4.2 Network Requirements and Configuration.....	7
4.2.1 Web Connection and Settings.....	8
4.3 Configuration Using Web Interface	8
4.3.1 Initial Setup.....	8
4.3.2 Wizard Setup.....	9
5. START-UP and OPERATION	14
5.1 Web Functions and Operation	14
5.1.1 Device.....	14
5.1.2 Matrix.....	22
5.1.3 VideoWall	23
5.1.4 Users.....	27
5.1.5 Controller Settings	29
5.1.6 TCP Command List.....	31
5.1.7 Firmware Update.....	38
5.1.8 Password Update.....	39
5.1.9 Log out.....	39
6. PANEL FUNCTIONS	40
6.1 Front Panel.....	40
6.2 Rear Panel.....	40
7. TECHNICAL DATA	41
7.1 Technical Specifications.....	41
7.2 Mechanical Diagram.....	42

PRECAUTIONS
PACKAGE CONTENTS
DESCRIPTION & FEATURES
INSTALL & CONNECT
START-UP & OPERATION
PANEL FUNCTIONS
TECHNICAL DATA

1. PRECAUTIONS

1.1 IMPORTANT REMARK



WARNING: SHOCK HAZARD - DO NOT OPEN

AVIS: RISQUE DE CHOC ÉLECTRIQUE - NE PAS OUVRIR



The lightning flash with arrowhead symbol, within an equilateral triangle, is intended to alert the user to the presence of uninsulated “dangerous voltage” within the product’s enclosure that may be of sufficient magnitude to constitute a risk of electric shock to persons.



The exclamation point within an equilateral triangle is intended to alert the user to the presence of important operating and maintenance (servicing) instructions in the literature accompanying the appliance.

WARNING (If applicable): The terminals marked with symbol of “⚡” may be of sufficient magnitude to constitute a risk of electric shock. The external wiring connected to the terminals requires installation by an instructed person or the use of ready-made leads or cords.

WARNING: To prevent fire or shock hazard, do not expose this equipment to rain or moisture.

WARNING: A device with Class I construction shall be connected to a mains socket-outlet with a protective earthing connection.



WARNING: This product must not be discarded, under any circumstance, as unsorted urban waste. Take to the nearest electrical and electronic waste treatment centre.

⚠ This equipment has been tested and found to comply with the limits for a Class A digital device, pursuant to part 15 of the FCC Rules. These limits are designed to provide reasonable protection against harmful interference when the equipment is operated in a commercial environment. This equipment generates, uses, and can radiate radio frequency energy and, if not installed and used in accordance with the instruction manual, may cause harmful interference to radio communications. Operation of this equipment in a residential area is likely to cause harmful interference in which case the user will be required to correct the interference at his own expense.



PRECAUTIONS

PACKAGE CONTENTS

DESCRIPTION & FEATURES

INSTALL & CONNECT

START-UP & OPERATION

PANEL FUNCTIONS

TECHNICAL DATA

1.2 IMPORTANT SAFETY INSTRUCTIONS

1. Read these instructions.
2. Keep these instructions.
3. Heed all warnings.
4. Follow all instructions.
5. Do not use this device near water.
6. Clean only with dry cloth.
7. Do not block any ventilation openings. Install in accordance with the manufacturer's instructions.
8. Do not install near any heat sources such as radiators, heat registers, stoves, or other device (including amplifiers) that produce heat.
9. Do not defeat the safety purpose of the polarized or grounding type plug. A polarized plug has two blades with one wider than the other. A grounding type plug has two blades and a third grounding prong. The wide blade or the third prong are provided for your safety. If the provided plug does not fit into your outlet, consult an electrician for replacement of the obsolete outlet.
10. Protect the power cord from being walked on or pinched particularly at the plugs, convenience receptacles, and at the point where they exit from the device.
11. Only use attachments/accessories specified by the manufacturer.
12. Unplug the device during lightening sorts or when unused for long periods of time.
13. Refer all servicing to qualified personnel. Servicing is required when the device has been damaged in any way, such as power supply cord or plug is damaged, liquid has been spilled or objects have fallen into the device, the device has been exposed to rain or moisture, does not operate normally, or has been dropped.
14. Disconnecting from mains: When switching off the POWER switch, all the functions and light indicators of the unit will be stopped, but fully disconnecting the device from mains is done by unplugging the power cable from the mains input socket. For this reason, it always shall remain easily accessible.
15. Equipment is connected to a socket-outlet with earthing connection by means of a power cord.
16. The marking information is located at the bottom of the unit.
17. The device shall not be exposed to dripping or splashing and that no objects filled with liquids, such as vases, shall be placed on device.

PRECAUTIONS
PACKAGE CONTENTS
DESCRIPTION & FEATURES
INSTALL & CONNECT
START-UP & OPERATION
PANEL FUNCTIONS
TECHNICAL DATA

1.3 CLEANING



Clean the unit with a soft, dry clean cloth or slightly wet with water and neutral liquid soap only, then dry it with a clean cloth. Be careful that water never gets into the unit through any hole. Never use alcohol, benzine, solvents or abrasive substances to clean this unit.

NEEC AUDIO BARCELONA, S.L. accepts no liability for any damage that may be caused to people, animal, or objects due to failure to comply with the warnings above.

**Thank you for choosing our device Ecler VEO-XCTRLG2!
We appreciate your trust.**

It is **VERY IMPORTANT** to carefully read this manual and to fully understand its contents before any connection in order to maximize your use and get the best performance from this equipment.

To ensure optimal operation of this device, we strongly recommend that its maintenance be carried out by our authorised Technical Services.

All ECLER products are covered by warranty, please refer to www.ecler.com or the warranty card included with this product for the period of validity and conditions.

2. PACKAGE CONTENTS

- 1 x Video over IP Controller
- 1 x 20kHz-60kHz 12V IR Receiver.
- 1 x 3-pin Euroblock Connector
- 1 x 6-pin Euroblock Connector
- 2 x Mounting Ears
- 4 x Machine Screws (KM3*6)
- 1 x 12V/1A Locking Power Adaptor
- 1 x Getting Started Guide.
- 1 x Warranty card

3. DESCRIPTION AND FEATURES

VEO-XCTRLG2 is a controller module that allows the user to manage and operate VEO-XTI1CG2 and VEO-XRI1CG2 video over IP devices in large multipoint to multipoint systems. It mounts two dedicated LAN ports to host independent Control and Video networks. VEO-XCTRLG2 offers a dedicated web interface that features a setup wizard, matrix control, videowall smart creation and operation, drag and drop source selection, video preview and TCP and RS-232 control commands. It supports POE function which makes this advanced managing tool a perfect fit more all sorts of AV over IP installations.

PRECAUTIONS
PACKAGE CONTENTS
DESCRIPTION & FEATURES
INSTALL & CONNECT
START-UP & OPERATION
PANEL FUNCTIONS
TECHNICAL DATA

3.1 MAIN FEATURES

- Easy to create project, control and manage the system.
- Setup wizard to easy assign devices to a project including Auto, DHCP and Manual IP configurations.
- HTTPS, SSH, SFTP security compatible.
- Built-in Web GUI control interface, supporting Drag & Drop operations and videowall management.
- Support image preview.
- Support video, audio, RS-232, control and management of the distributed system.
- Two dedicated LAN ports to host independent Control and Video networks.
- Support TCP and RS-232 port control and third-party central control.
- Multiple circuits protection, lightning protection and ESD design.
- Reliable system design, ensuring 7*24 hours reliable and stable work.
- PoE functionality.

PRECAUTIONS
PACKAGE CONTENTS
DESCRIPTION & FEATURES
INSTALL & CONNECT
START-UP & OPERATION
PANEL FUNCTIONS
TECHNICAL DATA

4. INSTALL & CONNECT

4.1 CONNECTION DIAGRAM

In a **typical configuration** the devices are connected like follows:

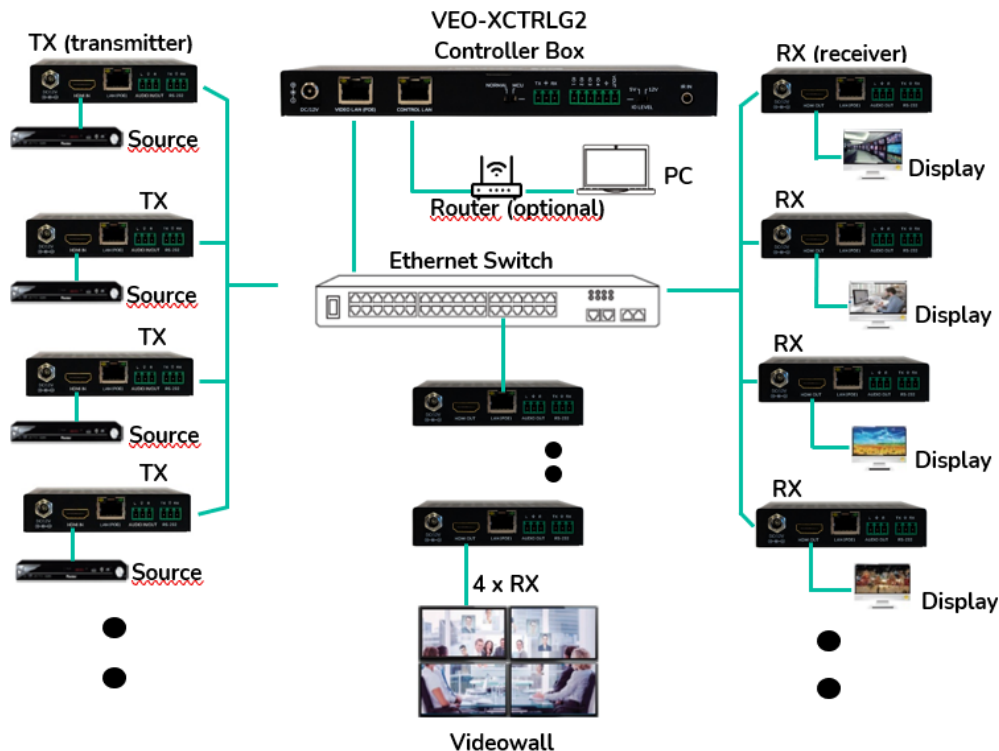

! When the Network Switch does not support PoE, then VEO-XTI1CG2, VEO-XRI1CG2 and VEO-XCTRLG2, should be powered by the included DC power adapter.

4.2 NETWORK REQUIREMENTS AND CONFIGURATION

VEO-XCTRLG2, is not limited to certain brands of network hardware, but the **network must support the following features:**

- Layer 3 managed network switch
- Support IGMP snooping.

! In order to prevent malfunctioning, interference or drop in signal performance due to other network products bandwidth requirements or network design, it is highly recommended to check with the chosen network IT staff how to properly set the Multicast products connected to the local network switch.

💡 One of the advantages in the use of VEO-XCTRLG2 is the **possibility to separate the Video Network to the Control Network**. In this way, the consistent multicast traffic generated by the video over IP extenders can be isolated from the control traffic generated by the embedded or by the third-party control system. We can think of VEO-XCTRLG2 as a **gateway between the control network and the video network**.

PRECAUTIONS
PACKAGE CONTENTS
DESCRIPTION & FEATURES
INSTALL & CONNECT
START-UP & OPERATION
PANEL FUNCTIONS
TECHNICAL DATA

4.2.1 WEB CONNECTION AND SETTINGS.

If there is no DHCP server in the system, the default IP addresses of VEO-XCTRLG2 for Control LAN Port is 192.168.6.100 and for its Video LAN Port is 169.254.8.100.

 **VEO-XTI1CG2 and VEO-XRI1CG2 must be set in the same network range as VEO-XCTRLG2 VIDEO LAN Port** in order to be able to configure and manage all the system. By default, subnet masks of VEO-XTI1CG2, VEO-XRI1CG2 and VEO-XCTRLG2 are set to 255.255.0.0

4.3 CONFIGURATION USING WEB INTERFACE

VEO-XCTRLG2 can be configured through its own built-in web interface which can be accessed through the following **two methods**:

- **Typing the chosen or the default IP address of the device** (192.168.6.100 if no DHCP server is used) in the web browser search tab.
- **Typing the URL “controller.local”** (this tag can be customized. For details, [see chapter Controller Settings](#)).

4.3.1 INITIAL SETUP

Upon initial access to the webpage, the **default credentials that must be entered are**:

The **default credentials** to log in are:

- **User name:** admin
- **Password:** admin

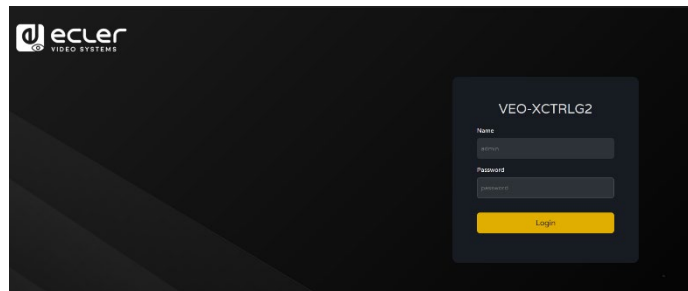

Once logged in, the system will prompt the user to change the password for the administrator automatically.

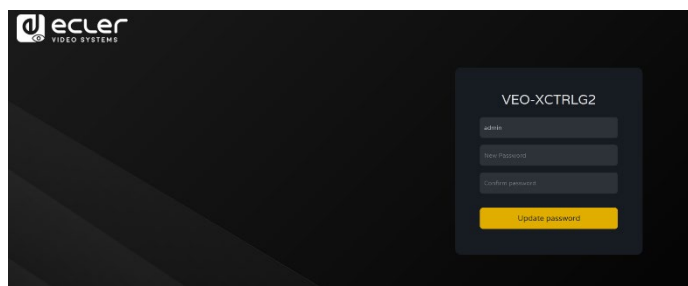

 **The new password must meet the minimum requirement of 6 characters and should be both secure and memorable. Users should avoid using easily guessable passwords or sharing them with unauthorized individuals.**



PRECAUTIONS
PACKAGE CONTENTS
DESCRIPTION & FEATURES
INSTALL & CONNECT
START-UP & OPERATION
PANEL FUNCTIONS
TECHNICAL DATA

4.3.2 WIZARD SETUP

Once logged in, **if there's no existing project, this message will appear to help the user to configure the system** through the wizard procedure.

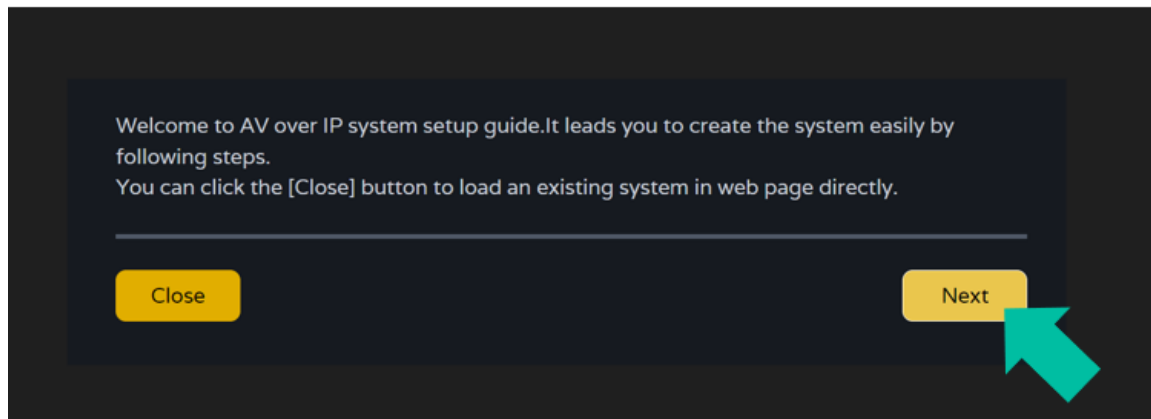
Then **click Next** to advance to the next page.









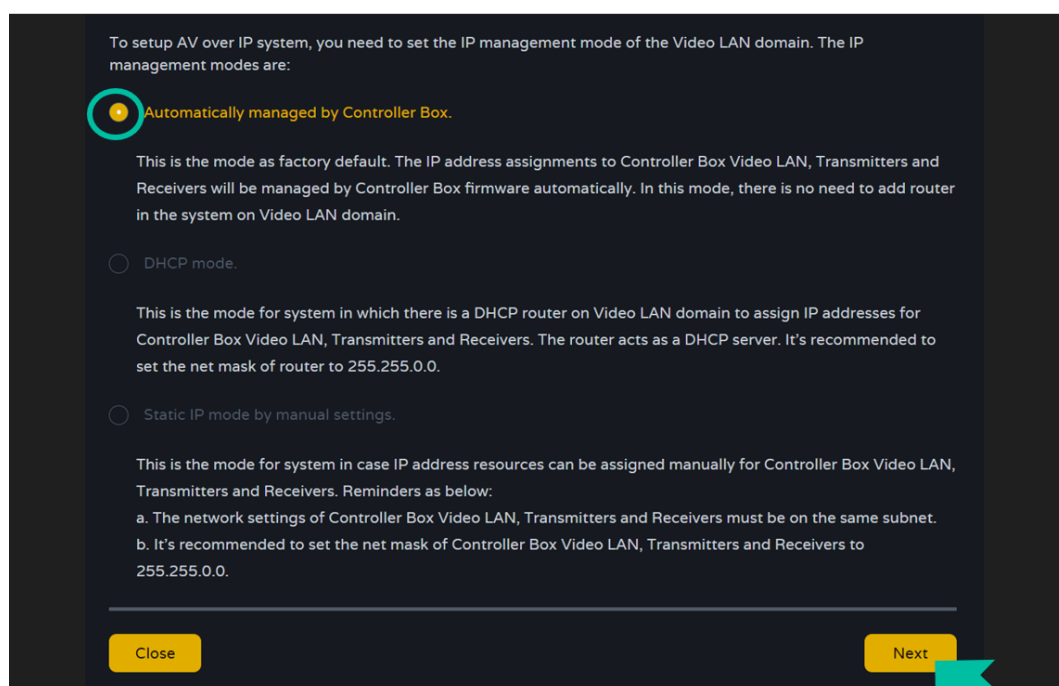

 If the system has already been configured previously, **clicking “Close” will take the user directly to the system control page.**

4.3.2.1 AUTOMATICALLY MANAGED BY CONTROLLER BOX

Select this option and once the IP address management settings have been selected, **the controller will proceed to scan for devices in the VIDEO network.**

Then **click Next** to advance to the next page.



-  PRECAUTIONS
-  PACKAGE CONTENTS
-  DESCRIPTION & FEATURES
-  INSTALL & CONNECT
-  START-UP & OPERATION
-  PANEL FUNCTIONS
-  TECHNICAL DATA

It will then be possible to decide whether to add all the connected devices to the new project (brand new installation) or to add them selectively in case of changes to an existing system.

1. If you select “Automatically add Transmitters and Receivers to system” and click the “Next” button to enter the Project page.

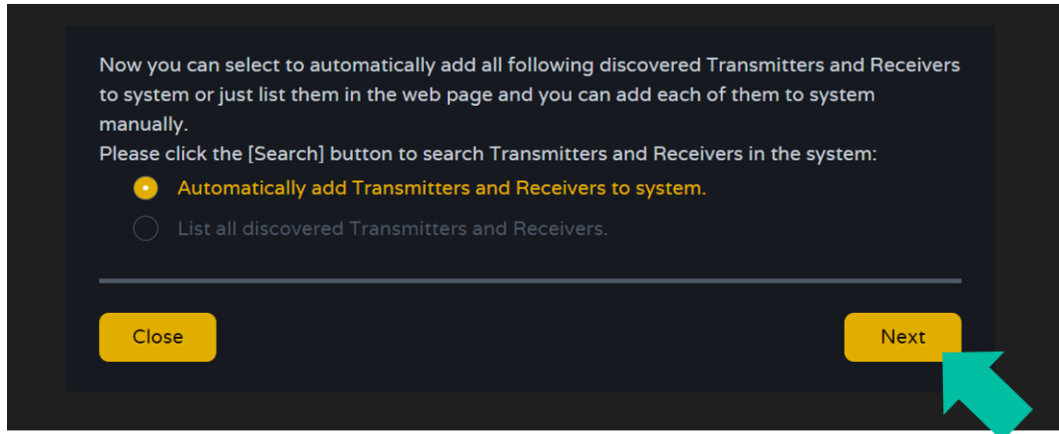

A pop up with the devices found after the search will show up.

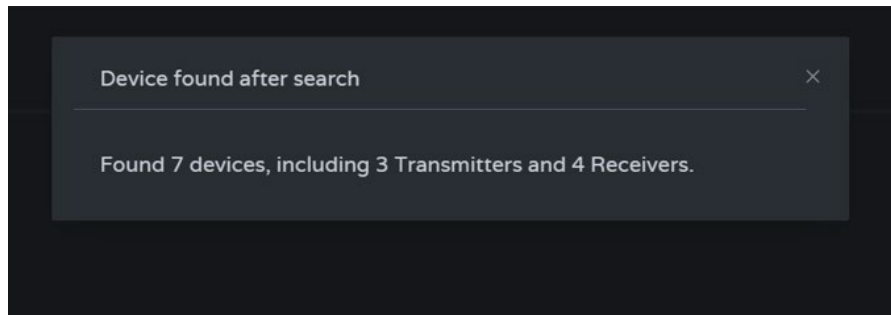

Then all the connected devices will be listed in the Transmitter and Receivers pages.

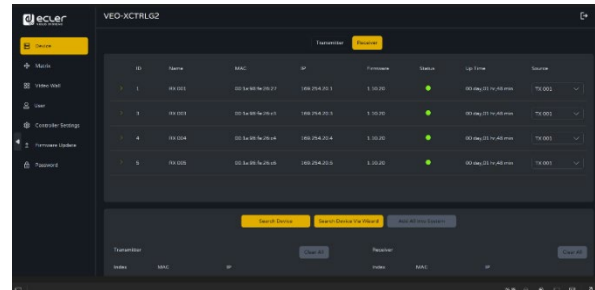
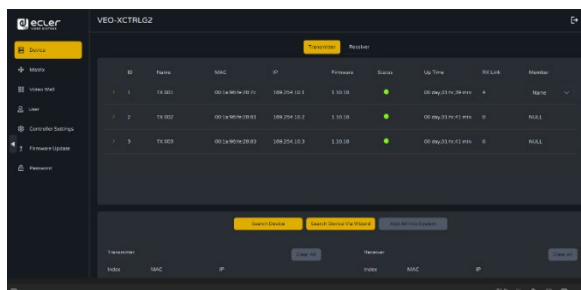

- PRECAUTIONS
- PACKAGE CONTENTS
- DESCRIPTION & FEATURES
- INSTALL & CONNECT
- START-UP & OPERATION
- PANEL FUNCTIONS
- TECHNICAL DATA

- If the second option is selected “List all discovered Transmitters and Receivers.” in the wizard windows and click the “Next” button to enter the Project page.

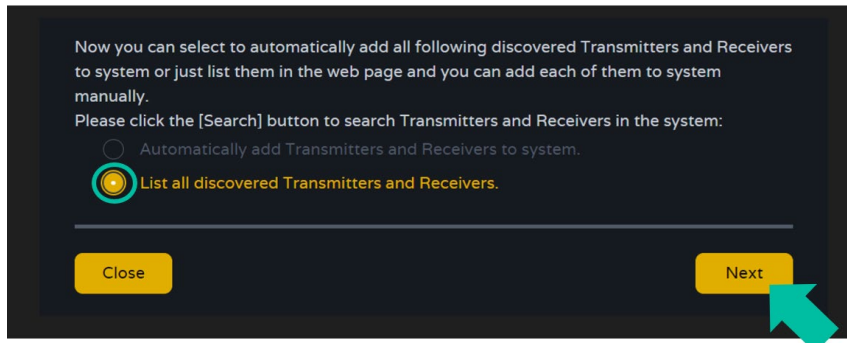

Then all the connected devices will be listed in the Unassigned Devices and the “Add All” and “Add” buttons behind Unassigned Transmitters and Unassigned Receivers will become operational.

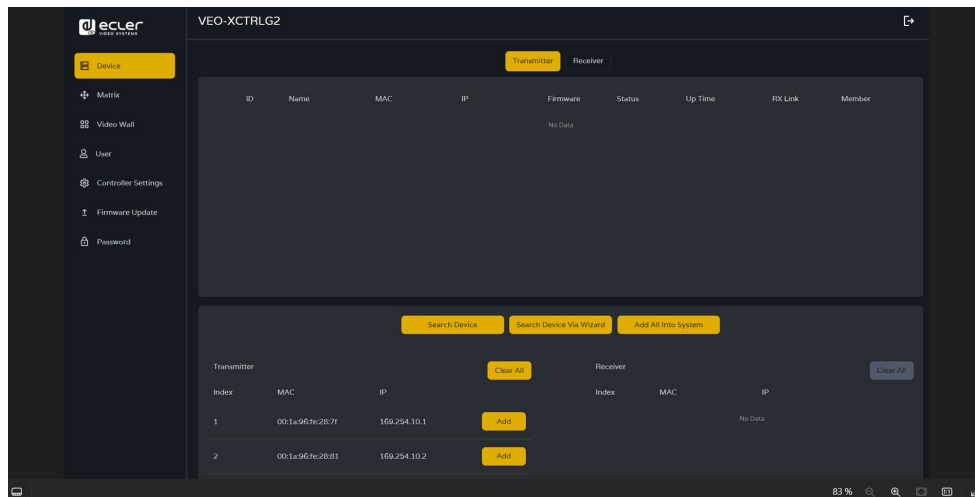

At this time, the “Add” button can be clicked behind each unregistered Transmitter or Receiver to add the device to the project one by one or click the “Add All” button to add all Transmitters or Receivers to the project.

Transmitters and Receivers that have been added to the project will appear on top of the Device section in the Transmitter and Receiver pages.

4.3.2.2 DHCP MODE

The procedure is identical to the previous one, with the only difference that in this case **the IP addresses are assigned by a DHCP server.**

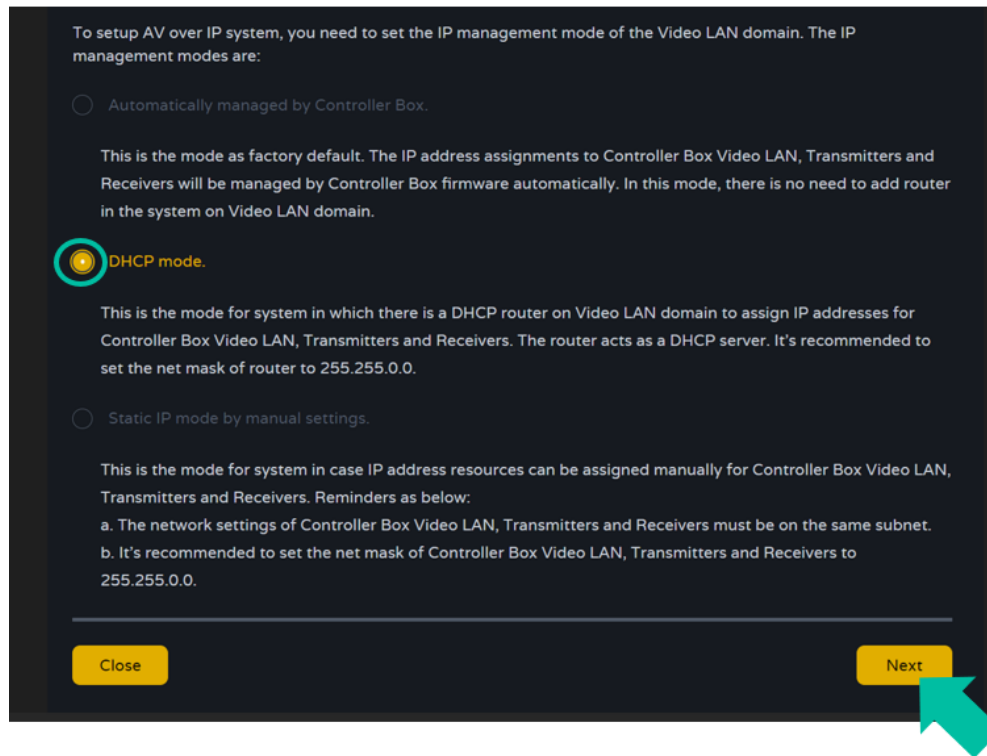

A pop-up warning will show up when changing to DHCP mode

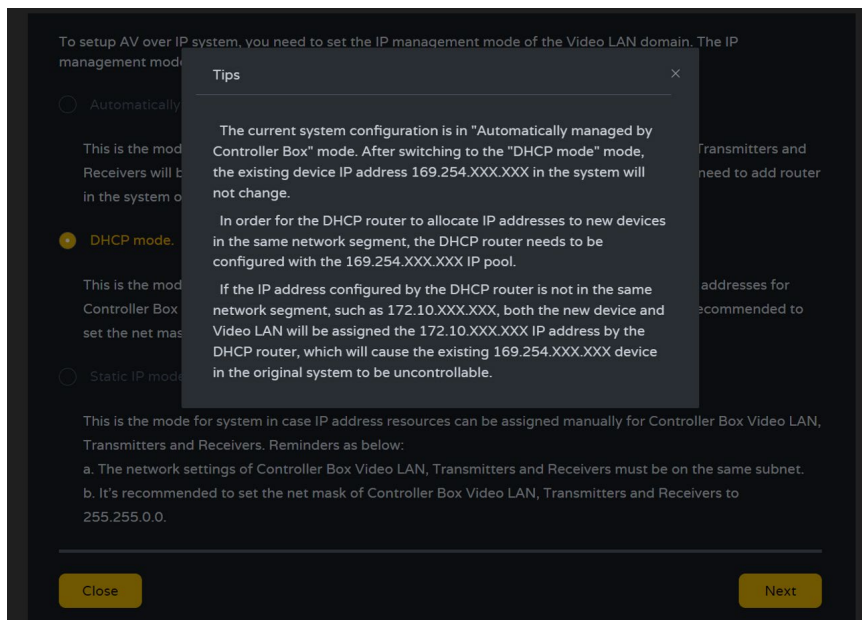

 There will be no need to set up the **Video LAN port settings of the VEO-XCTRLG2 controller box** in Auto or DHCP as they **will be automatically configured by the controller.**

PRECAUTIONS
PACKAGE CONTENTS
DESCRIPTION & FEATURES
INSTALL & CONNECT
START-UP & OPERATION
PANEL FUNCTIONS
TECHNICAL DATA

4.3.2.3 STATIC IP MODE BY MANUAL SETTINGS

1. Select the **static IP mode by manually settings option**, to manually enter the IP address.

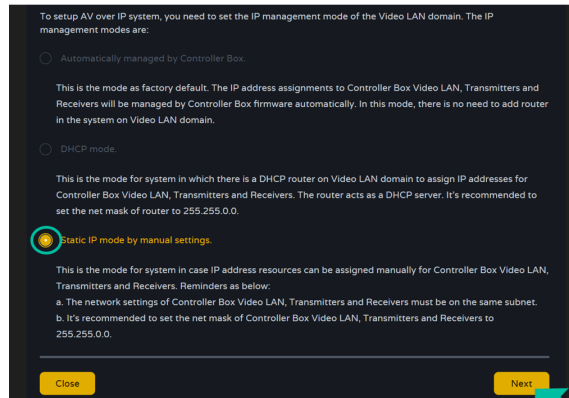

2. Press Next and then manually set the IP address, subnet mask and gateway of the Video LAN and then press Next.

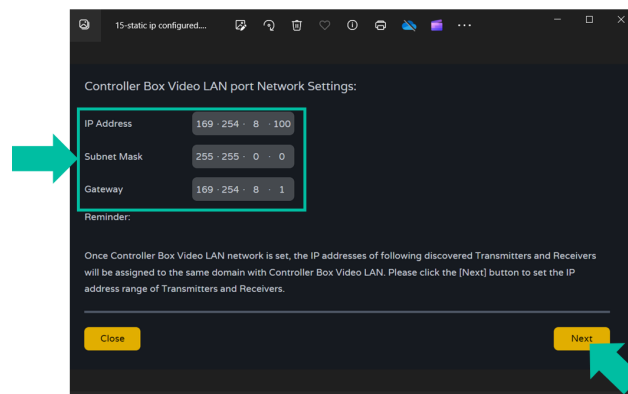

! It's strongly recommended to use different IP network domain from Control LAN port.

3. After the progress reaches 100%, enter the interface as shown in the figure below. On this interface, you can **set the IP address range of Transmitters and Receivers**. Once the setting is complete, **click the "Next" button** and the rest of the steps are the same as the first "Automatically Managed by Controller Box" mode.

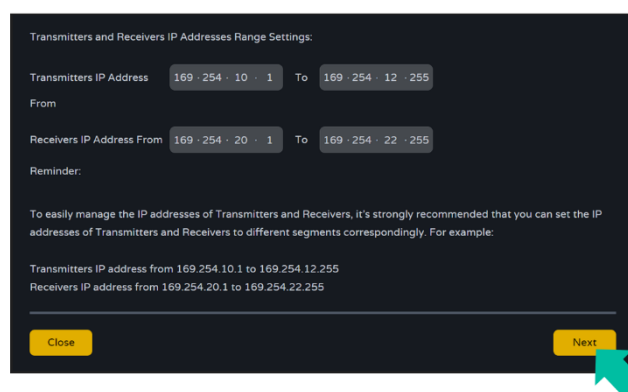

- PRECAUTIONS
- PACKAGE CONTENTS
- DESCRIPTION & FEATURES
- INSTALL & CONNECT
- START-UP & OPERATION
- PANEL FUNCTIONS
- TECHNICAL DATA

5. START-UP and OPERATION

5.1 WEB FUNCTIONS AND OPERATION

After setting up VEO-XCTRLG2 and assigning the VEO-XTI1CG2 and VEO-XRI1CG2 devices connected to the network to a given project, the **following menus of the web settings page will let the user manage and operate different aspects and functionalities concerning Transmitter and Receiver operation as explained in the next chapters.**

5.1.1 DEVICE

This section allows the user to **create a Project**.

- A. Transmitter / Receiver:** Shows devices that have been added to the current project. Click Transmitter or Receiver to display the **list of the Transmitters** or Receivers respectively and the information of each one linked to the project. For more information [see chapter Transmitters](#) or [Receivers](#) respectively,

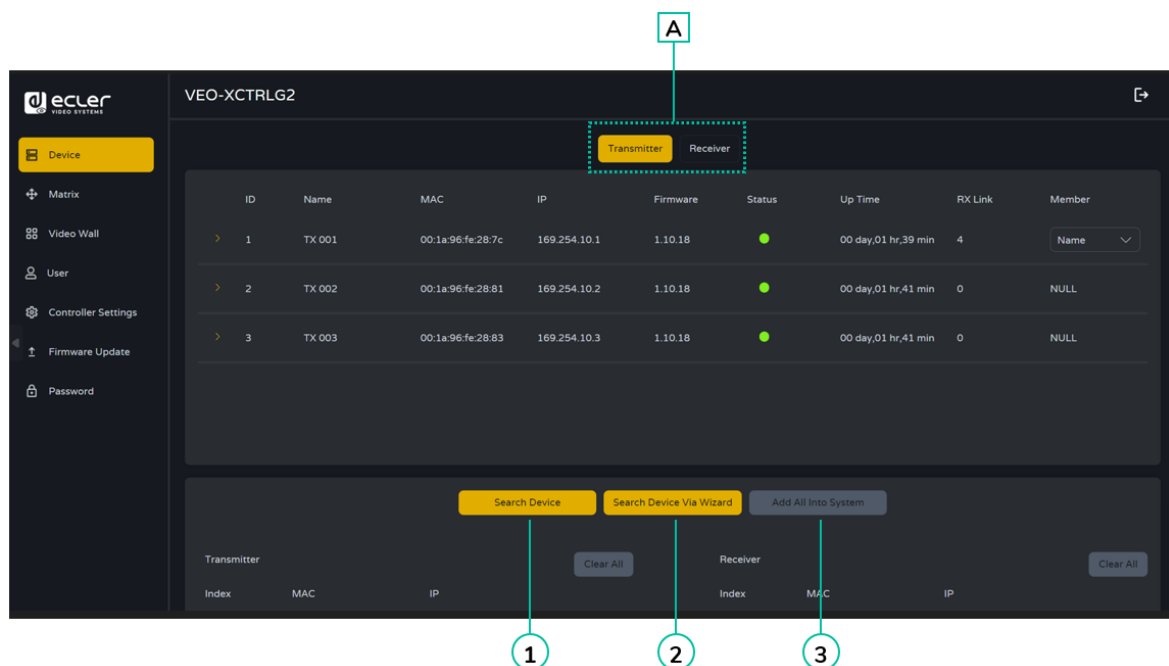

To add Devices to the current project:

1. Click **“Search Device”** to search the unassigned devices that do not appear in the current project.
2. Click **“Search Device Via Wizard”** to change to Wizard Setup and search new devices. [For more information see chapter Wizard Setup.](#)
3. Click **“Add all into system”** to add all the unassigned devices to the current project.

5.1.1.1 TRANSMITTERS

This page allows to **setup the current Transmitter** as required.

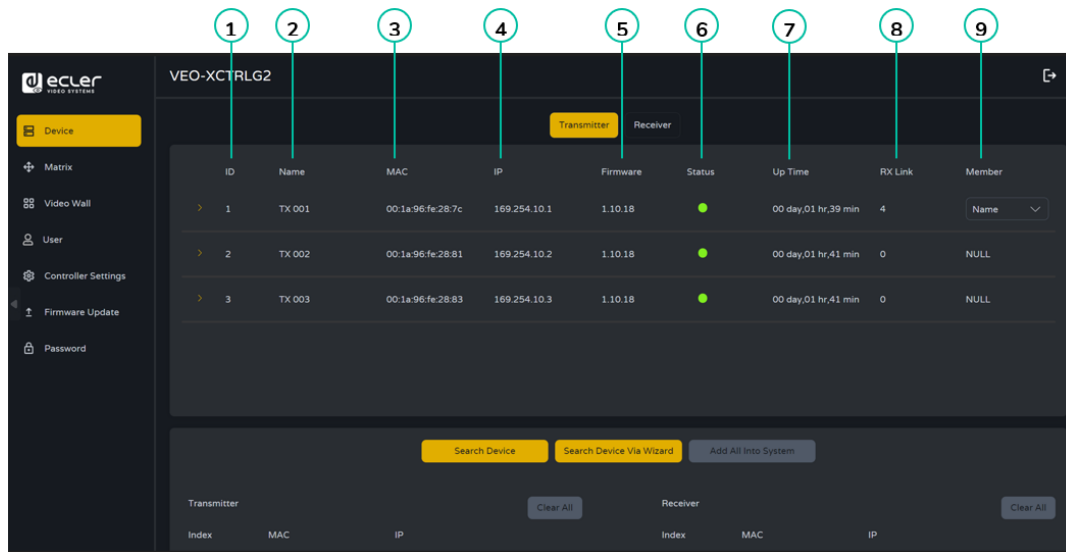

1. **ID:** The ID of the current device. (Note: ID is never duplicated.)
2. **Name:** The name of the current device. (Note: Name can't never be duplicated.).
3. **MAC Address:** The MAC Address of the current device.
4. **IP Address:** The IP Address of the current device.
5. **Firmware:** The Firmware version No. of the current device.
6. **Status:** The status (online or offline) of the current device.
7. **Up Time:** The time the current device has been up.
8. **Rx Link:** Receivers tuned to the current device.
9. **Member:** Name of the receiver linked to the current device.

 **Click the arrow icon placed left to "ID" column to see the expanded management menu to check the detail information about the current Transmitter and tweak as needed, as shown in below.**

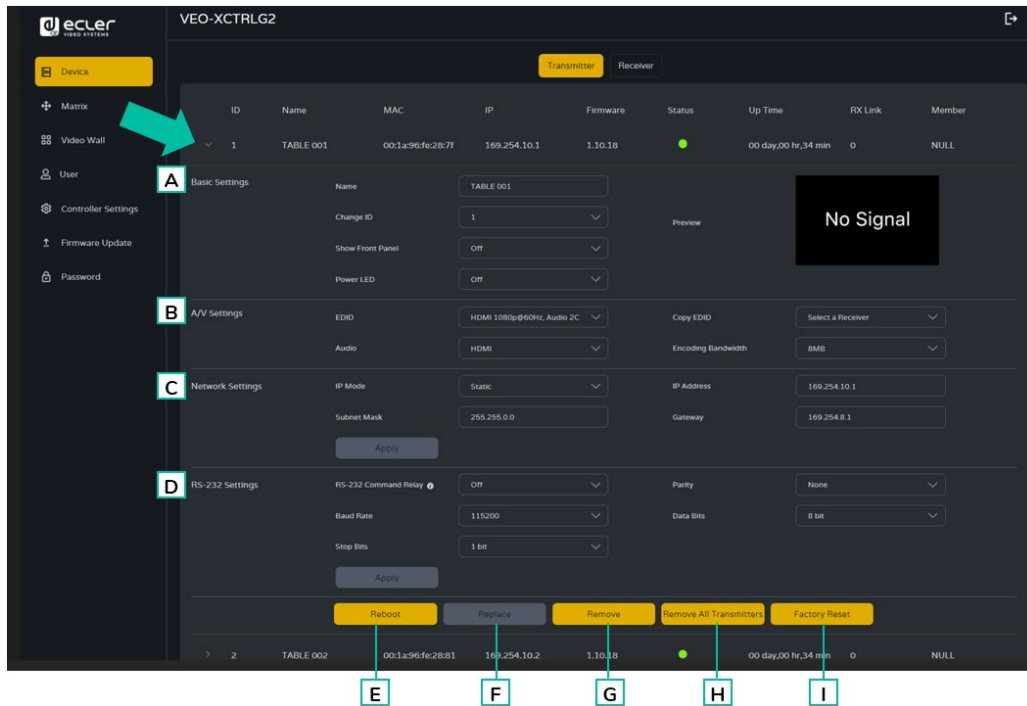

A Basic settings:

1. **Name:** The name of the current device. (Note: Name can't never be duplicated.)
2. **Change ID:** The ID of the current device. (Note: ID is never duplicated.)
3. **Show Front Panel:** This parameter selects the status of the Front Panel 7 segments LEDs:
 - **ON:** The LEDs stay permanently ON.
 - **OFF:** The LEDs have a 90s timeout, and they turn off.
4. **Power LED:**
 - **ON:** The Power LED stays permanently blinking.
 - **OFF:** The Power LED stays still without blinking.
 - **ON 90s:** The Power LED blinks for 90s and then stops.
5. **Preview:** This screen shows a preview visualization of the current video content of the selected Transmitter.

B A/V Settings:

1. **EDID:** The EDID of the current device.
2. **Audio:** The Audio Selection of the current device (Analogue or HDMI®).
3. **Copy EDID:** lets the user assign an external EDID,
4. **Encoding Bandwidth:** this parameter adjusts the video quality choosing the maximum transmitted data for the mainstream.

C Network settings:

1. **IP Mode:** The configuration defining how IP addresses are assigned in a network (STATIC/ DHCP).
2. **Subnet Mask:** A mask used to separate the part of the IP address that identifies the network and the part that identifies devices on that network.
3. **IP Address:** A unique identifier assigned to each device on a network to enable communication within that network.
4. **Gateway:** A device that acts as an entry or exit point for communication between different networks or between a network and the internet.



Click “Apply” to keep the changes.

D **RS-232 Settings:** This submenu lets the user to configure the settings for a serial communication. The user also will be able to turn “Serial Guest Mode” on or off. [Please refer to chapter RS-232 Routing to learn the types of RS-232 command transmission in the system.](#)

1. **RS-232 Command Relay:** When enabled, this feature disables the Receiver's Locked Signal Routing.
2. **Baud Rate:** The speed at which data is transmitted between devices.
3. **Stop Bits:** The number of bits used to indicate the end of a data character in serial communication (1bit / 2 bit).
4. **Parity:** A method used to detect errors in transmitted data by adding an additional bit (NONE/ODD/EVEN).
5. **Data Bits:** The number of bits used to represent each character of data in serial communication (5 to 8 bit).



Click “Apply” to keep the changes.

E **Reboot:** This parameter lets the user reboot the selected Transmitter.

F **Replace:** Lets the user to replace an Offline device for another one that has been factory defaulted.

G **Remove:** This option will let the user to unassign the selected Transmitter from the current project.

H **Remove all Transmitters:** This option will let the user to unassign all the Transmitters from the current project.

I **Factory Reset:** This parameter lets the user get the selected Transmitter back to default settings.



PRECAUTIONS
PACKAGE CONTENTS
DESCRIPTION & FEATURES
INSTALL & CONNECT
START-UP & OPERATION
PANEL FUNCTIONS
TECHNICAL DATA

5.1.1.2 RECEIVERS

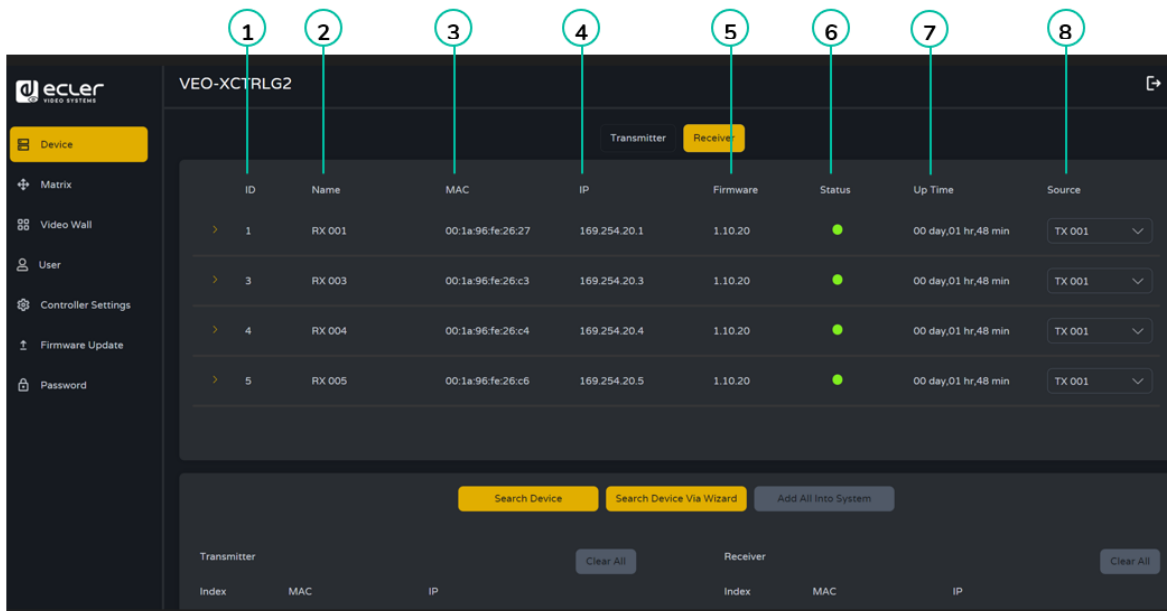
On this page, the user can **setup the current Receiver as required.**



1. **ID:** The ID of the current device. (Note: ID is not duplicated.).
2. **Name:** The name of the current device. (Note: Name is not duplicated.).
3. **MAC:** The MAC Address of the current device.
4. **IP:** The IP Address of the current device.
5. **Firmware:** The Firmware version of the current device.
6. **Status:** The status (online or offline) of the current device.
7. **Up time:** The uptime of a device represents the continuous operational duration since its last reboot or restart, indicating its reliability and availability for use.
8. **Source:** The signal source (Transmitter) of the current device.

 **Click the arrow icon placed left to “ID” column to see the expanded management menu to check the detail information about the current Transmitter and tweak as needed, as shown in below.**

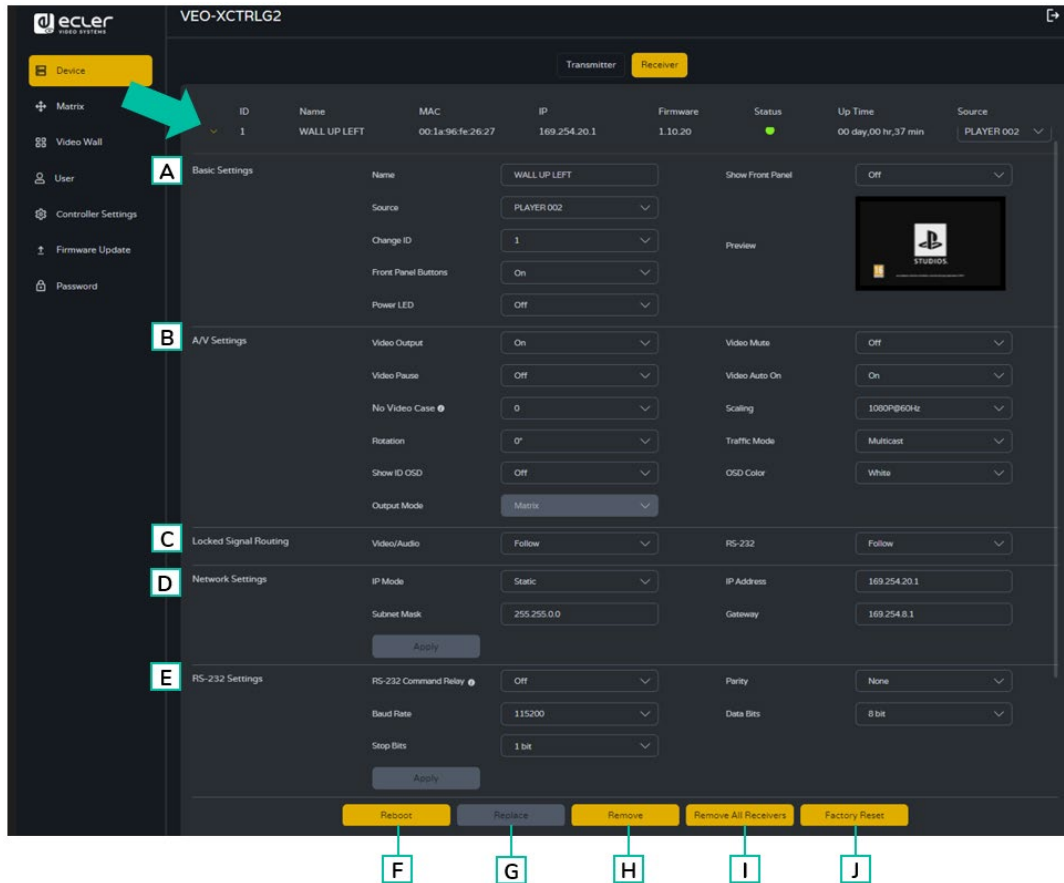

A. Basic settings:

1. **Name:** The name of the current device. (Note: Name can't never be duplicated.).
2. **Source:** The signal source (Transmitter) of the current device.
3. **Change ID:** The ID of the current device. (Note: ID is never duplicated.)
4. **Front Panel Buttons:** This parameter lets the user enable and disable the front panel buttons.
5. **Power LED:**
 - **ON:** The Power LED stays permanently blinking.
 - **OFF:** The Power LED stays still without blinking.
 - **ON 90s:** The Power LED blinks for 90s and then stops.
6. **Show Front Panel:** This parameter selects the status of the Front Panel 7 segment LEDs:
 - **ON:** The LEDs stay permanently ON.
 - **OFF:** The LEDs have a 90s timeout, and they turn off.
7. **Preview:** This screen shows a preview visualization of the current video content of the selected Transmitter.

B A/V Settings:

1. **Video Output:** This parameter turns off the HDMI® output.
2. **Video Pause:** This parameter freezes the last frame shown.
3. **No Video Case:** This parameter is a Timeout After Video Lost and it will turn off HDMI® output when there's no video signal detected after the chosen time period (minutes).
4. **Rotation:** This parameter will rotate the output image from 0° to 270°.
5. **Show ID OSD:** this parameter shows the current Product ID on the screen.
6. **Output Mode:** The mode of the current device (Matrix or Videowall).
7. **Video Mute:** This parameter shows a black screen instead of the actual content.
8. **Video Audio On:** This parameter allows to turn video signal on when a new RX is connected.
9. **Scaling:** The resolution of the current device.
10. **Traffic Mode:** lets the user assign between Unicast and Multicast network topology.

 When using TX unicast flow, it can provide up to four main stream flows, or 16 sub stream flows.

11. **OSD Color:** This parameter allows to change the colour of the data shown in the screen.

- C Locked Signal Routing:** the user can independently route the different types of signals between Transmitter & Receiver devices (Video/Audio, Serial). This allows to establish a permanent connection that can be used for a locked routing for some certain source devices or an extending control for a third-party control system.

 When the drop-down box shows "FOLLOW", the corresponding signal will come from current Transmitter device.

 When Serial Guest Mode is disabled, Locked Signal Routing is enabled.

D Network Settings:

1. **IP Mode:** The configuration defining how IP addresses are assigned in a network (STATIC/ DHCP).
2. **Subnet Mask:** A mask used to separate the part of the IP address that identifies the network and the part that identifies devices on that network.
3. **IP Address:** A unique identifier assigned to each device on a network to enable communication within that network.
4. **Gateway:** A device that acts as an entry or exit point for communication between different networks or between a network and the internet.

 Click "Apply" to keep the changes.



PRECAUTIONS

PACKAGE CONTENTS

DESCRIPTION & FEATURES

INSTALL & CONNECT

START-UP & OPERATION

PANEL FUNCTIONS

TECHNICAL DATA

E. **RS-232 Settings:** This submenu lets the user to configure the settings for a serial communication. The user also will be able to turn “Serial Guest Mode” on or off. [Please refer to chapter RS-232 Routing to learn the types of RS-232 command transmission in the system.](#)

1. **RS-232 Command Relay:** When enabled, this feature disables the Receiver's Locked Signal Routing.
2. **Baud Rate:** The speed at which data is transmitted between devices.
3. **Stop Bits:** The number of bits used to indicate the end of a data character in serial communication (1bit / 2 bit).
4. **Parity:** A method used to detect errors in transmitted data by adding an additional bit (NONE/ODD/EVEN).
5. **Data Bits:** The number of bits used to represent each character of data in serial communication (5 to 8 bit).



Click “Apply” to keep the changes.

- F **Reboot:** This parameter lets the user reboot the selected Receiver.
- G **Replace:** Lets the user to replace an Offline device for another one that has been factory defaulted.
- H **Remove:** This option will let the user to unassign the selected Receiver from the current project.
- I **Remove all Receivers:** This option will let the user to unassign all the Receivers from the current project.
- J **Factory Reset:** This parameter lets the user get the selected Receiver back to default settings.

5.1.1.3 RS-232 ROUTING

“Serial Guest Mode” can be enabled/disabled on the Transmitter / Receiver web setting page. [See chapter Transmitters](#) or chapter [Receivers](#) to assign the RS-232 type of routing:

- **ON:** turned on it allows the RS-232 connection of a device to be sent over the IP network (IP / RS232 command in, to RS-232 out). This will allow third party control systems the ability to send an RS-232 or IP command to the VEO-XCTRLG2 and a RS-232 command to be sent out of a Receiver or a Transmitter as a result.



It is recommended turning “Serial Guest Mode” on and off when required as serial commands being sent into the VEO-XCTRLG2 will be forwarded to every device that has it enabled. When Serial Guest Mode is enabled, Locked Signal Routing is disabled.



PRECAUTIONS

PACKAGE CONTENTS

DESCRIPTION & FEATURES

INSTALL & CONNECT

START-UP & OPERATION

PANEL FUNCTIONS

TECHNICAL DATA

- **OFF:** a static fixed routing for distributing two-way RS-232 commands between a set of Transmitters and all the associated Receivers that have Fixed Routing configured. So, this serial connection allows point to point, point to multipoint and multipoint to multipoint serial bidirectional transmitting scenarios.



When Serial Guest Mode is disabled, Locked Signal Routing is enabled.

5.1.2 MATRIX

This page allows to **select and preview the video content of a given Transmitter or Receiver placed in the system** by drag and drop the device to visualize into a receiver.

1. **Transmitter: Display all the current Transmitters.** The text in the figure is the name of the device.
2. **Receiver: Display all the current Receivers.** The text on the first line is the name of the Receiver, and the text on the second line refers to the Transmitter where the signal resource is from.

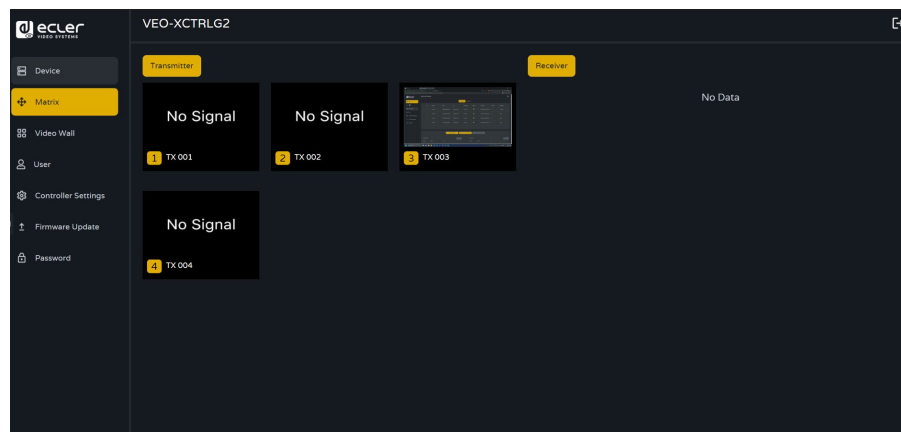

Please note that the user can also drag and drop one transmitter to the option “All receivers”. This automatically assigns the device selected to all the receivers available. If the receivers disappear note that when a group of receivers is assigned to a video wall, they are removed from the matrix section. When the video wall is removed, the receivers will become available in the matrix section again.

5.1.3 VIDEOWALL

This section is divided in two pages. In each one, allows the user to create and manage the listed video walls and the source selected in the videowall.

5.1.3.1 VIDEOWALL LIST

On this page, the user can **create and configure videowall** as required.

- Each Receiver can be set into a part of a videowall layout.
- Each system can contain multiple video walls with different sizes.
- Each video wall can be assigned to different screens and different layouts that range from 1x2 up to 9x9.

The controller creates and manages the videowall configurations and provides a **simplified control interface and API commands** to third party control system.

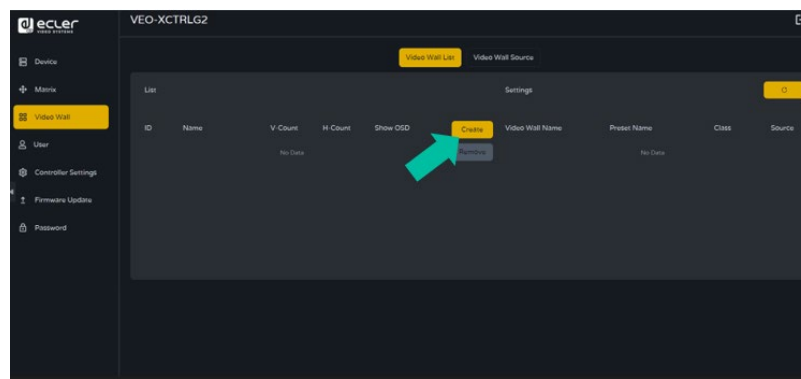

1. Click “Create”, then a pop-up window will be shown as below.

The user can set the **Video Wall ID, Name, Horizontal and Vertical panel numbers**.

Then click “Create” to create the Video Wall.

- Remove button is used to delete the videowall set up.

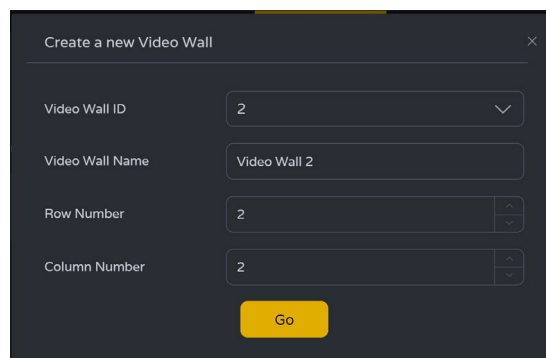

- Up to 9 videowalls can be created.

- PRECAUTIONS
- PACKAGE CONTENTS
- DESCRIPTION & FEATURES
- INSTALL & CONNECT
- START-UP & OPERATION
- PANEL FUNCTIONS
- TECHNICAL DATA

2. Select the video wall that you want to configure on the “Video Wall List”, then click “Assign Receiver” to enter the Receiver assignment page.

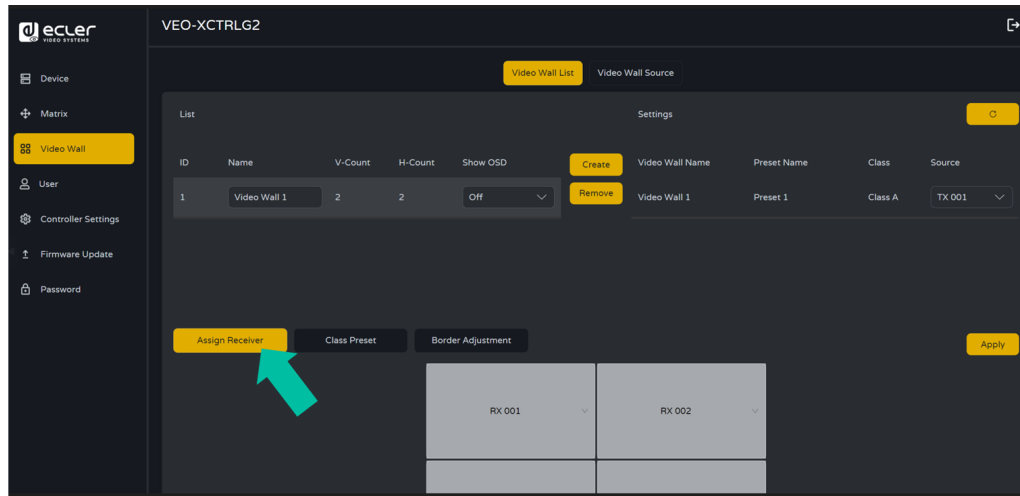

3. Click each screen to select the corresponding Receiver device, then click “Apply”.

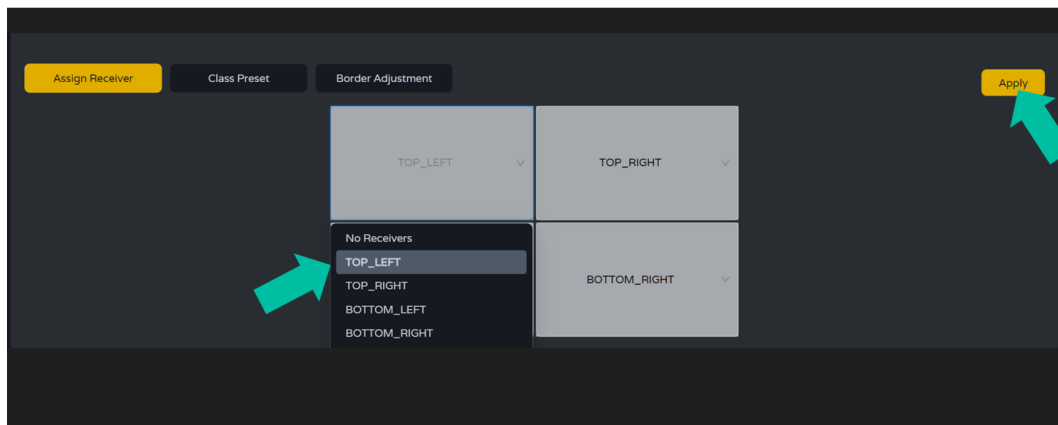

! A Receiver can only be assigned to one videowall.

! When a group of receivers is assigned to a video wall, they are removed from the matrix section. When the video wall is removed, the receivers will become available in the matrix section again.

- PRECAUTIONS
- PACKAGE CONTENTS
- DESCRIPTION & FEATURES
- INSTALL & CONNECT
- START-UP & OPERATION
- PANEL FUNCTIONS
- TECHNICAL DATA

- Click “Class Preset” to enter the class configuration page, then click each screen to select the corresponding Class as required (the same class name will form a video wall and a regular or irregular video wall can be created by Class Configuration). Then click “Apply”.

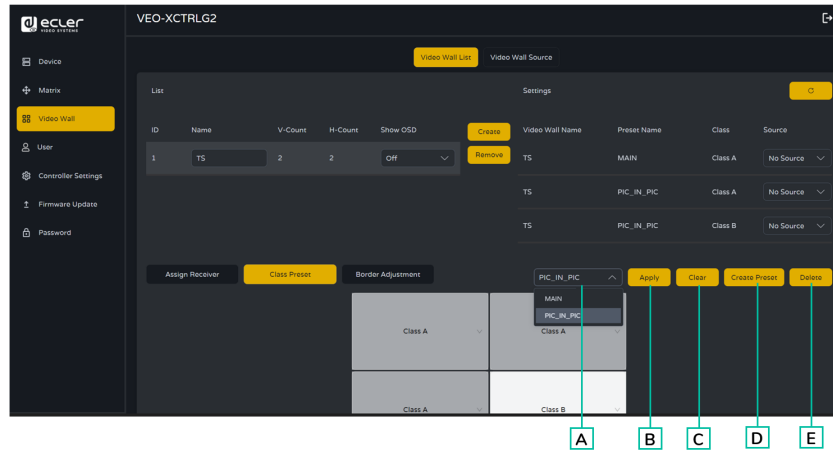

- Preset name:** Dropdown menu with all the presets’ names.
- Apply:** when changes are made in the current preset, apply to the project.
- Clear:** Clears the current video wall preset and sets up all the displays in the same class.
- Create Preset:** to create a new preset.
- Delete:** Delete the current preset.

The user can create a class preset and edit it selecting between the presets available.

- Main mode:** the entire video wall is assigned to the same class.
- Picture in picture mode:** allows combination between different sources in the same video wall structure (main and a secondary attendees).

- Click “Create Preset”, then a pop-up window will be shown as below.

Class ID and Name can be set.
Then click “Go” to create the Class Preset.

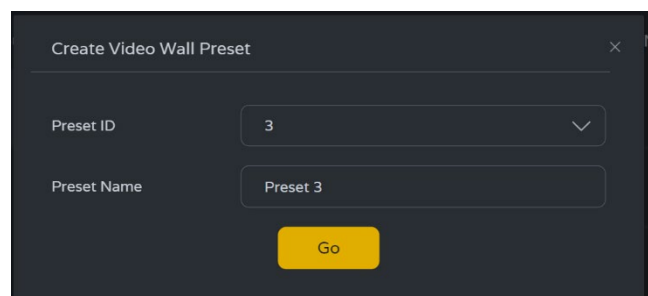

Up to 7 configurations can be set up for different application scenarios.

- Click **“Border Adjustment”** to enter the adjustment configuration of each display. This allows the user to adjust the width and the height of the display.

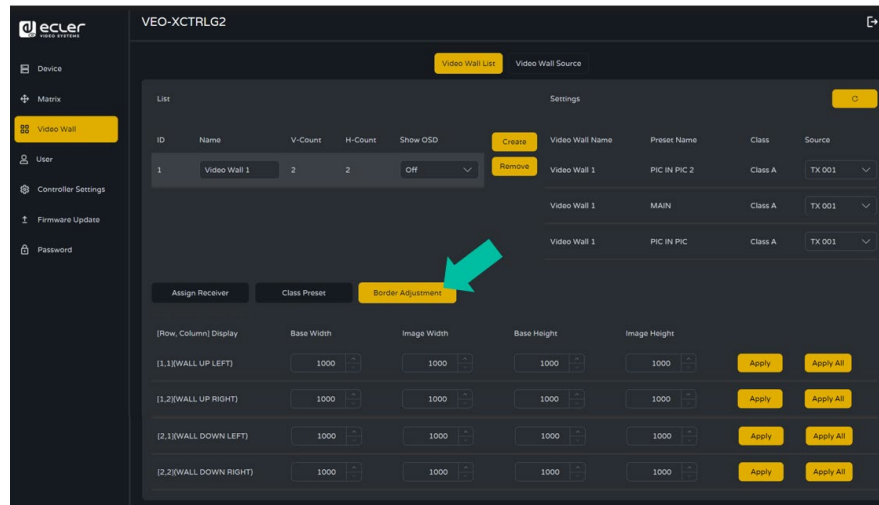

5.1.3.2 VIDEO WALL SOURCE

This page allows to **select different videowalls and class preset configurations** that have been set up on the “Video Wall List” page.

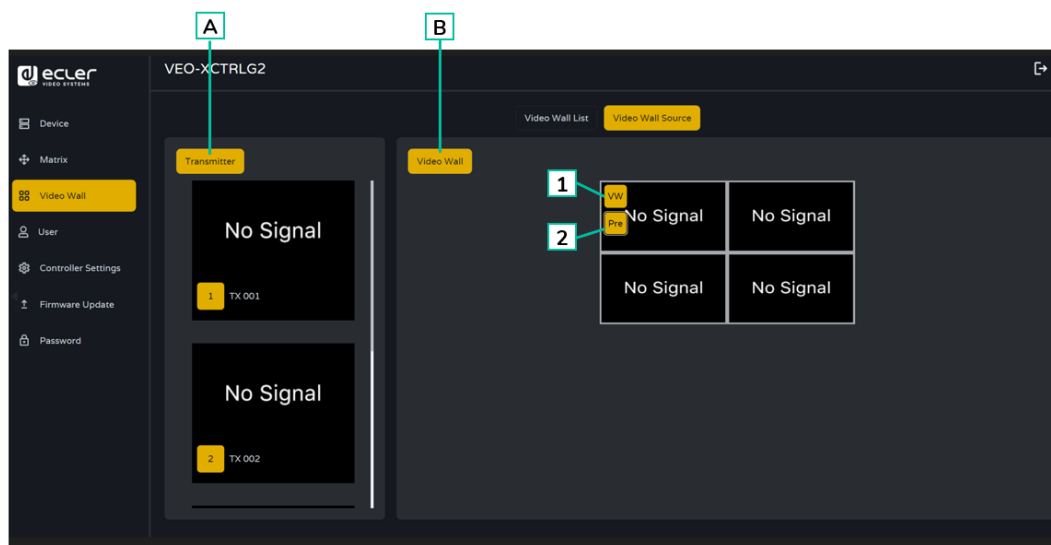

A. Transmitter: Column list of the Transmitters’ preview of the project.

B. Video Wall: Current Video Wall preview.

- VW:** a Video Wall project can be selected.
- Pre:** Class preset can be selected.

Dragging Transmitters at the left column of the page and drop the device to the videowall will assign the selected Transmitter to the chosen Receiver (and associated screen on the video wall composition).

5.1.4 USERS

On this page, **new user accounts can be added**. The controller web GUI can be setup with different users each with their own control privileges. This will allow the user to create a unique login and feature settings such as inputs and outputs that each person has access to.

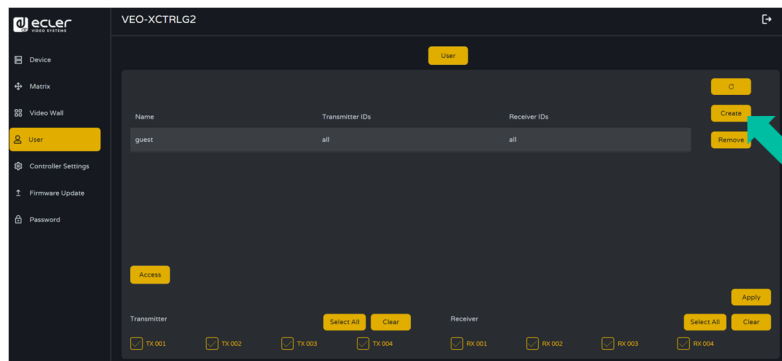

1. Click “Create” to create a new user.

Click “Access” button to manage user access privileges. The user can choose which transmitters and receivers the new user he has created can access. Click “Apply” once the configuration of the devices needed on the user is complete to save changes.

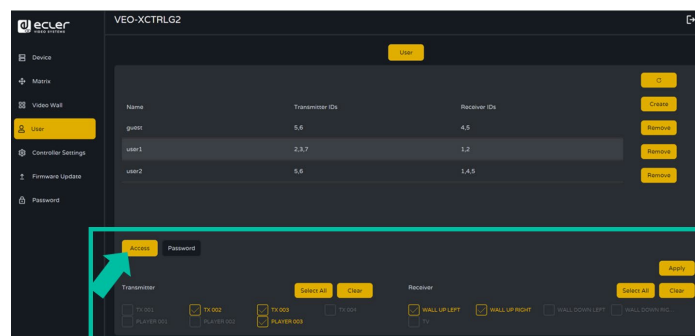

2. Click “Password” button and select the user profile to change the password.

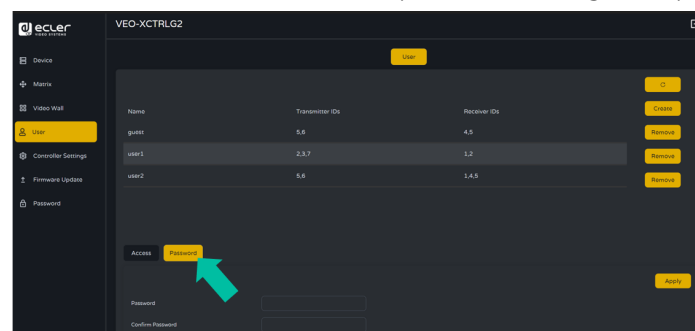

5.1.4.1 USER INTERFACE

Log Out the Admin interface and Log In [with the credentials set up in the previous step.](#)

Once Logged In, the user will have access to Matrix and Video Wall sections and that will allow the user to drag and drop any source in both sections.

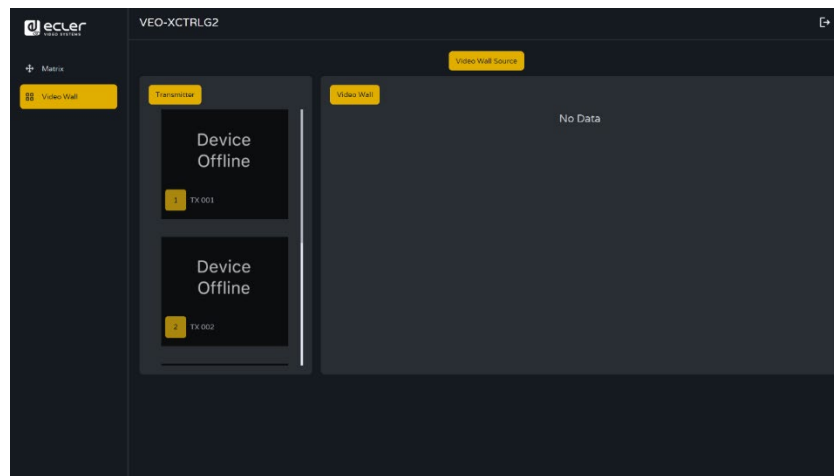
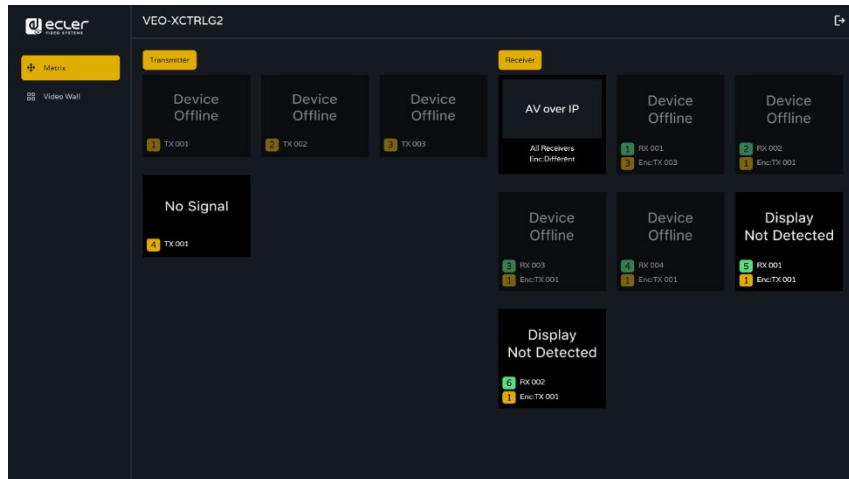

 Note that the user interface will only be able to see the previously selected transmitters and receivers.

- PRECAUTIONS
- PACKAGE CONTENTS
- DESCRIPTION & FEATURES
- INSTALL & CONNECT
- START-UP & OPERATION
- PANEL FUNCTIONS
- TECHNICAL DATA

5.1.5 CONTROLLER SETTINGS

On this page, the user can configure communication and network settings for the control and video LAN networks as required.

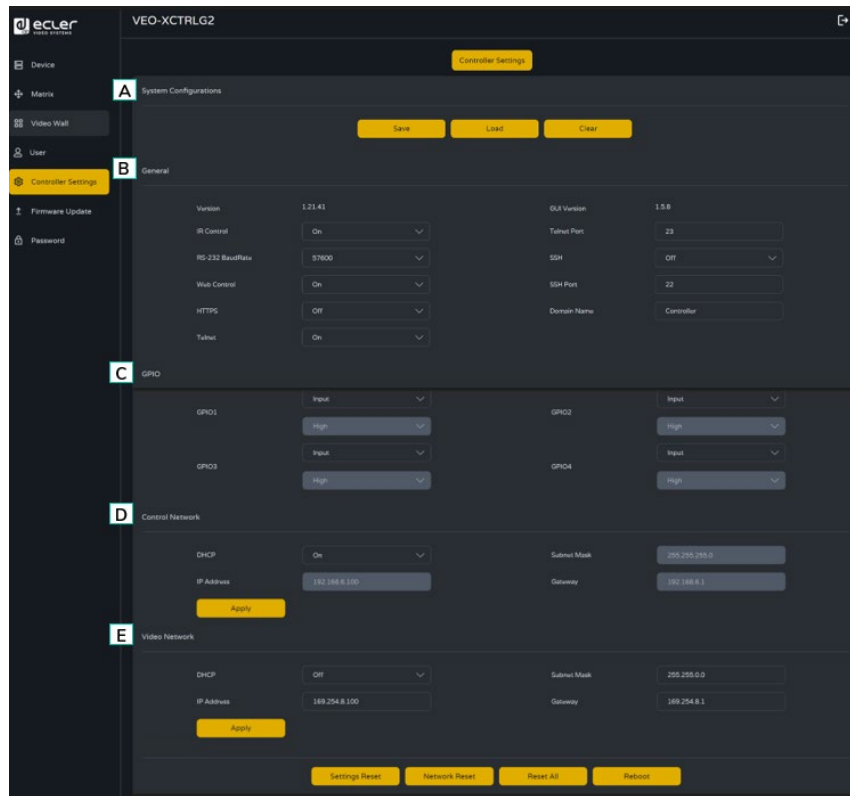

A. System Configurations:

1. Click “**Save Project**” to save the project file (config_file.json), so that you can use the saved project next time without scanning devices again.
2. Click “**Load Project**” to load the project file (config_file.json) to recover the saved project.
3. Click “**Clear Project**” to clear the current project, then you will need to setup devices again.

B. General:

1. **Version:** Identifies the specific release or iteration of a software or hardware product.
2. **IR Control:** Using infrared signals to remotely control electronic devices.
3. **RS-232 BaudRate:** The speed at which data is transmitted over a RS-232 serial connection.
4. **Web Control:** Controlling a device or system through a web interface accessible via a web browser.
5. **HTTPS:** A secure communication protocol used over the internet, providing encryption and authentication.



PRECAUTIONS

PACKAGE CONTENTS

DESCRIPTION & FEATURES

INSTALL & CONNECT

START-UP & OPERATION

PANEL FUNCTIONS

TECHNICAL DATA

6. **Telnet:** A network protocol used for remote terminal access to devices or systems.
 7. **GUI Version:** A graphical user interface (GUI) representation of a software application's version.
 8. **Telnet Port:** The network port used for Telnet communication.
 9. **SSH:** Secure Shell, a network protocol for secure remote access and control of devices or systems.
 10. **SSH Port:** The network port used for SSH communication.
 11. **Domain name:** allows the user to change the domain tag that can be used instead of the current IP address to enter the Web GUI and entering the new name.
- C. **GPIO:** allows users to configure general-purpose input/output ports for interfacing with external systems or peripherals, enabling event triggering and external device control. Refer to chapter [TCP Command List](#) to check the instructions associated with GPIO manual configuration allowing a user to write its own scripted routines.
- D. **Control Network:** This section allows the user to set the network configuration and DHCP parameters for the VEO-XCTRLG2 “Control LAN” port.
- E. **Video Network:** This section allows the user to set the network configuration for the VEO-XCTRLG2 “Video LAN” port.

 Click “Apply” to keep the changes.

 Click “Apply” to keep the changes.

PRECAUTIONS
PACKAGE CONTENTS
DESCRIPTION & FEATURES
INSTALL & CONNECT
START-UP & OPERATION
PANEL FUNCTIONS
TECHNICAL DATA

5.1.6 TCP COMMAND LIST

To make use of TCP 3rd party remote control, it is necessary to enter current IP address of VEO-XCTRLG2 and TELNET port (23 by default) configured to access the device.

! To access to telnet the user must write “telnet [controller IP]”. Then, to visualize the data of all the devices connected to the controller, execute "get status".

! The list of commands below is accessible through a Telnet session utilizing the command 'help'.

! It is important to add carriage return (<CR>,\r,0x0D) and line feed (<LF>,\n,0x0A) characters at the end of each command.

How do you have to enter the command?

To launch a remote control command, it needs to be written as follows:

“<Command> [Param 1] <Variable> [Param 2]”

[Param 1], [Param 2] will not always be required for every command.

EXAMPLE OF USE:

Switch the channel of transmission of a VEO-XRI1CG2 (Rx) to receive the content of a VEO-XTI1CG2 (Tx) :

- VEO-XTI1G2: "Local ID" parameter defines a unique ID for the transmitter as well as the transmission channel.
- VEO-XRI1CG2: "Local ID" parameter defines a unique ID for the receiver. "Source Local ID" defines the transmission channel in which the receiver is tuned to.







[See chapter “Startup and Operation” for further details.](#)

The command to use is “SET DEC [dec] SWITCH [enc] ALL”

“SET DEC 1 SWITCH 2 ALL\r\n”

VEO-XRI1CG2 with Local ID 1 will switch its “Source local ID” to 2, tuning all services (video, audio, RS-232) to channel transmission 2 assigned the VEO-XTI1CG2 with “Local ID” 2.

System Control		
Command	Variable	Description
SET IR [state]	<ul style="list-style-type: none"> • state = [ON, OFF] 	Set controller IR control ON or OFF.
SET RS232BAUDRATE [a]	a = [0:115200, 1:57600, 2:38400, 3:19200, 4:9600]	Set RS-232 baud rate to a bps.

-  PRECAUTIONS
-  PACKAGE CONTENTS
-  DESCRIPTION & FEATURES
-  INSTALL & CONNECT
-  START-UP & OPERATION
-  PANEL FUNCTIONS
-  TECHNICAL DATA

SET REBOOT		Reboot controller.
SET RESET		Reset controller system settings
	NETWORK	Reset controller network settings.
	ALL	Reset controller system en network

Transmitter and Receiver Control		
Command	Variable	Description
SET ENC [enc] ⁽¹⁾ PRESET or SET DEC [dec] ⁽²⁾ PRESET	IPMODE [mode] • mode=[0:AUTOIP 1:DHCP 2:STATIC]	Preset transmitter or receiver ip mode.
	START IP [start address] • start address = [xxx.xxx.xxx.xxx]	Preset transmitter or receiver start ip address.
	END IP [end address] • end address = [xxx.xxx.xxx.xxx]	Preset transmitter or receiver end ip address.
	GW [gateway ip] • gateway ip=[xxx.xxx.xxx.xxx]	Preset transmitter or receiver gateway ip address.
	SM [subnetmask] • subnetmask = [xxx.xxx.xxx.xxx]	Preset transmitter or receiver subnet mask address.
	APPLY	Apply the transmitter or receiver preset ip configuration.
SET ENC [enc] ⁽¹⁾ IPMODE	DHCP	Set the transmitter dhcp mode.
	STATIC	Set the transmitter static ip address.
SET ENC [enc] ⁽¹⁾ or SET DEC [dec] ⁽²⁾	STATIC IP [ip address] • ip address = [xxx.xxx.xxx.xxx]	Set the transmitter static ip address.
	STATIC GATEWAY [gateway ip] • gateway ip=[xxx.xxx.xxx.xxx]	Set the transmitter static gateway address.
	STATIC MASK [subnetmask] • subnetmask = [xxx.xxx.xxx.xxx]	Set the transmitter static subnet mask address.
	STATIC MASK [mask] • mask = [xxx.xxx.xxx.xxx]	Set the transmitter network reboot.
	NETWORK REBOOT	Delete the transmitter in the current configuration.
	ID [id] • id = [1..762]	Set the index ID of the transmitter or receiver.
	DELETE	Delete the transmitter or receiver in the current configuration.
	REBOOT	Set the transmitter reboot.
	RESET	Set the transmitter factory reset.
	NAME [name] • name: max 16 characters	Set the name of the transmitter.

PRECAUTIONS
PACKAGE CONTENTS
DESCRIPTION & FEATURES
INSTALL & CONNECT
START-UP & OPERATION
PANEL FUNCTIONS
TECHNICAL DATA

	LED [state] • state = [ON, OFF]	Set the transmitter flash power LED or disable flash power LED.
	LED ON 90	Set the transmitter flash power LED timeout in 90 seconds.
	FPLED [fl] • fl: [0: Always On 9: On 90s]	Set the transmitter front panel LED automatic off time.
	GUEST [state] BR [br] BIT [bit] • state = [ON, OFF] • br = [0:300 1:600 2:1200 3:2400 4:4800 5:9600 6:19200 7:38400 8:57600 9:115200] • bit = Data Bits + Parity + Stop Bits example: 8n1 Data Bits=[5..8], Parity=[n o e] Stop Bits=[1..2]	Set the transmitter serial guest configuration.
	GUEST	Start serial guest mode to transmitter “enc” or receiver “dec”
	IR VOL [vol] • vol = [5V, 12V]	Set the transmitter IR voltage 5V or 12V.
EXITGUEST		To close guest mode
GET ENC [enc] ⁽¹⁾ or GET DEC [dec] ⁽²⁾	STATUS	Get the transmitter Status.
SET ENC [enc] ⁽¹⁾	STREAM BITRATE [rate] • rate = [0:1Mb 1:4Mb 2:8Mb 3:16Mb 4:20Mb]	Set the transmitter stream encoding bitrate.
	AUDIO FORMAT [format] • state = [PCM, AAC]	Set the transmitter audio encoding format PCM or AAC.
	EDID COPY [dec] ⁽²⁾	Set the transmitter EDID copy from receiver.
	EDID DEFAULT [edid] • edid = 00: HDMI 1080p@60Hz, Audio 2CH PCM 01: HDMI 720p@60Hz, Audio 2CH PCM 02: DVI 1280x1024@60Hz, Audio None 03: DVI 1920x1080@60Hz, Audio None 04: DVI 1920x1200@60Hz, Audio None 05: HDMI 1920x1200p@60Hz, Audio 2CH PCM	Set the transmitter Default EDID.



PRECAUTIONS

PACKAGE CONTENTS

DESCRIPTION & FEATURES

INSTALL & CONNECT

START-UP & OPERATION

PANEL FUNCTIONS

TECHNICAL DATA

	06: Copy EDID 07: User EDID 1 08: User EDID 2	
SET DEC [dec] ⁽²⁾ SWITCH [enc] ⁽¹⁾	ALL	Set the receiver switch all signals. Note: enc=0 mean no source in this case
	VIDEO	Set the receiver switch video only signals.
	IR	Set the receiver switch IR only signals.
	RS232	Set the receiver switch RS232 only signals.
	USB	Set the receiver switch USB only signals.
SET DEC [dec] ⁽²⁾ OUTPUT	[state] • state = [ON, OFF]	Set the receiver output ON or OFF.
	OSD [state] • state = [ON, OFF]	Set the receiver output to show ID OSD or hide ID OSD.
	OSD ON 90	Set the receiver output show ID OSD timeout in 90 seconds.
	OSD COLOR [co] • co = [0:WHITE 1:GRAY 2:BLACK 3:RED 4:MAROON 5:YELLOW 6:OLIVE 7:LIME 8:GREEN 9:AQUA 10:TEAL 11:BLUE 12:NAVY 13:FUCHSIA 14:PURPLE]	Set the receiver output OSD color.
	RESOLUTION [res] • res = [0:Bypass 1:1080p@60 2:1080p@50 3:1080p@30 4:1080p@25 5:1080p@24 6:720@p60 7:720p@50 8:576p@50 9:480p@60 10:640x480@60 11:800x600@60 12:1024x768@60 13:1280x800@60 14:1280x1024@60 15:1366x768@60 16:1440x900@60 17:1600x1200@60 18:1680x1050@60 19:1920x1200@60]	Set the receiver output resolution.
	ROTATE [rtt] • rtt = [0:0 1:90 2:180 3:270]	Set the receiver output rotate.
	PAUSE [state] • state = [ON, OFF]	Set the receiver output pause ON or OFF.
	MUTE [state]	Set the receiver output mute ON or OFF.

PRECAUTIONS
PACKAGE CONTENTS
DESCRIPTION & FEATURES
INSTALL & CONNECT
START-UP & OPERATION
PANEL FUNCTIONS
TECHNICAL DATA

	<ul style="list-style-type: none"> state = [ON, OFF] 	
	AUTO [state] <ul style="list-style-type: none"> state = [ON, OFF] 	Set the receiver output Automatically ON or OFF.
	LOST [time] <ul style="list-style-type: none"> time = [0...60] 	Set the receiver output video lost timeout in minute. Note: time = 0 Output lost disabled.
SET DEC [dec] ⁽²⁾	BUTTON [state] <ul style="list-style-type: none"> state = [ON, OFF] 	Set the receiver front panel button enable ON or OFF.
	IR [state] <ul style="list-style-type: none"> state = [ON, OFF] 	Set the receiver rear panel IR enable ON or OFF.
	MODE [mode] <ul style="list-style-type: none"> mode = [MX, VW] 	Set the receiver output mode to matrix or video wall.
	STREAM [stream] <ul style="list-style-type: none"> stream = [UNICAST, MULTICAST] 	Set the receiver output stream transmission mode UNICAST or MULTICAST.

- ⁽¹⁾enc=000: All transmitters
enc=[001...762]: One transmitter
- ⁽²⁾dec=000: All receivers
dec=[001...762]: One receiver

Video wall control		
Command	Variable	Description
CREATE WALL	HANDLE [hdl] ⁽³⁾	Create video wall.
DELETE WALL	HANDLE [hdl] ⁽³⁾	Delete video wall.
SET WALL HDL [hdl] ⁽³⁾	NAME [name] <ul style="list-style-type: none"> name: max 16 characters 	Set the video wall name.
	C [c] R [r] <ul style="list-style-type: none"> c=[01...09]: Number of columns in video wall r=[01...09]: Number of rows in video wall 	Set the video wall columns and rows .
CREATE WALL HDL [hdl] ⁽³⁾	PRESET [prs] ⁽⁴⁾	Set the video wall position (h,v) receiver.
DELETE WALL HDL [hdl] ⁽³⁾	PRESET [prs] ⁽⁴⁾	Create video wall preset.

HOME
PRECAUTIONS
PACKAGE CONTENTS
DESCRIPTION & FEATURES
INSTALL & CONNECT
START-UP & OPERATION
PANEL FUNCTIONS
TECHNICAL DATA

SET WALL HDL [hdl] ⁽³⁾ PRESET	[prs] NAME [name] : • name: max 16 characters	Delete video wall preset.
	[prs] ⁽⁴⁾ CLASS [cls] ⁽⁵⁾ H [h] ⁽⁶⁾ V [v] ⁽⁷⁾	Set the video wall preset name.
	[prs] ⁽⁴⁾ CLASS [cls] ⁽⁵⁾ SOURCE [enc] ⁽¹⁾	Set the video wall preset position (H,V) as class.
	[prs] ⁽⁴⁾ MATRIX H [h] ⁽⁶⁾ V [v] ⁽⁷⁾	Set the video wall preset class from the source.
	[prs] ⁽⁴⁾ MATRIX H [h] ⁽⁶⁾ V [v] ⁽⁷⁾ SOURCE [enc] ⁽¹⁾	Set the video wall preset to specify the location as a matrix mode.
SET WALL HDL [hdl] ⁽³⁾	H [h] ⁽⁶⁾ V [v] ⁽⁷⁾ WIDTH BEZEL BW [o] ⁽⁸⁾ IW [w] ⁽⁹⁾	Set the video wall preset class from the source.
	H [h] ⁽⁶⁾ V [v] ⁽⁷⁾ HEIGHT BEZEL BH [o] ⁽⁸⁾ IH [w] ⁽⁹⁾	Set the video wall position (h,v) base width and image width.
GET WALL HDL [hdl] ⁽³⁾	STATUS	Get the video status
APPLY WALL HDL [hdl] ⁽³⁾	PRESET [prs] ⁽⁴⁾	Apply video wall preset.

⁽³⁾ hdl=[01...09]: Video wall handle

⁽⁴⁾ prs=[01...09]: Preset index

⁽⁵⁾ cls=[A...G]: Class index

⁽⁶⁾ h=[01...09]: Horizontal position in video wall

⁽⁷⁾ v=[01...09]: Vertical position in video wall

⁽⁸⁾ o=[100...1000]: Screen base width/height

⁽⁹⁾ w=[100...1000]: Screen image width/height

Device management		
Command	Variable	Description
SEARCH		Search all transmitters and receivers.
	RESET	Reset search transmitters and receivers.
GET SEARCH	STATUS	Get the search status.
ADD DEV [dev] • dev=[01...n]: Search list index value	ENC [enc] ⁽¹⁾	Add new transmitter devices.
	DEC [dec] ⁽²⁾	Add new receiver devices.
	RESET	Reset all transmitter/receiver/videowall/search configurations.
ADD	AUTO ALL	Automatically add transmitters and receivers for all new searches.

GPIO control		
Command	Variable	Description
SET GPIO [gpio] ⁽¹⁰⁾	DIR [dir] • dir = [IN, OUT]	Set the controller gpio as input or output.
	LEVEL [level] • level = [LOW, HIGH]	Set the controller gpio output low level or high level.
GET GPIO [gpio] ⁽¹⁰⁾	LEVEL	Get the controller gpio input level.
	STATUS	Get the controller gpio status.

⁽¹⁰⁾ gpio=00: All IO ports
 gpio=[01...04]: One IO port

Network control		
Command	Variable	Description
SET NETWORK LAN [lan] • lan=LAN1: Video LAN(POE) • lan=LAN2: Control LAN(Web GUI)	DHCP [state] • state = [ON, OFF]	Set the controller network dhcp ON or OFF.
	IP [ip adress] • ip address =[xxx.xxx.xxx.xxx]	Set the controller network static ip address.
	STATIC GATEWAY [gateway ip] • gateway ip =[xxx.xxx.xxx.xxx]	Set the controller network static gateway address.
	STATIC MASK [subnetmask] • subnetmask =[xxx.xxx.xxx.xxx]	Set the controller network static subnet mask address.
SET NETWORK	REBOOT	Set the controller network reboot.
	TELNET [state] • state = [ON, OFF]	Set the controller network telnet ON or OFF.
	TELNET PORT [port] • port=[22...65535]	Set the controller network telnet port.
	SSH [state] • state = [ON, OFF]	Set the controller network ssh ON or OFF.
	SSH PORT [port] • port=[22...65535]	Set the controller network ssh port.
	HTTPS [state] • state = [ON, OFF]	Set the controller network https ON or OFF.
	WEB [state] • state = [ON, OFF]	Set the controller network web GUI ON or OFF.
	DNS [hostname]	Set the controller network domain name to hostname.

- PRECAUTIONS
- PACKAGE CONTENTS
- DESCRIPTION & FEATURES
- INSTALL & CONNECT
- START-UP & OPERATION
- PANEL FUNCTIONS
- TECHNICAL DATA

5.1.7 FIRMWARE UPDATE

On this page, the user **can separately update the firmware of any Transmitter/Receiver** by clicking the corresponding “Update” button on the right or update all the firmware of Transmitter/Receiver simultaneously by clicking the corresponding “Update All” button.

There is also the **possibility to upload the User EDID1 and User EDID2** by clicking the “Upload User EDID1” and ” Upload User EDID2” buttons respectively.

To **separately update the firmware** of any Transmitter/Receiver:

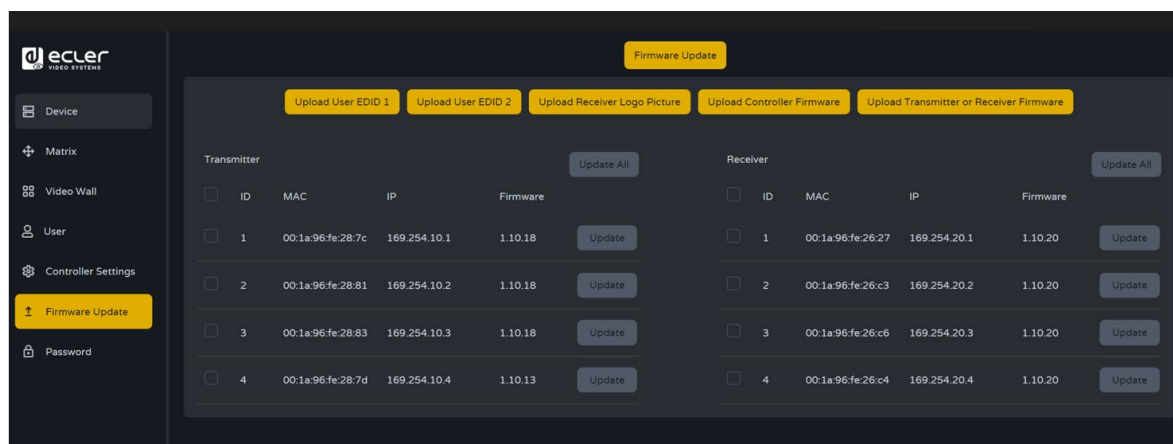

- Transmitter / Receiver **firmware can be updated one by one** by clicking the “**Update**” **button** on the right of each Transmitter / Receiver.
- **Firmware of all Transmitters / Receivers can be updated simultaneously** by clicking the “**Update All**” button of Transmitter / Receiver.

Once clicked the “Update” button a progress bar will show up and it will be updated in a short time (about 1 minute approx.)

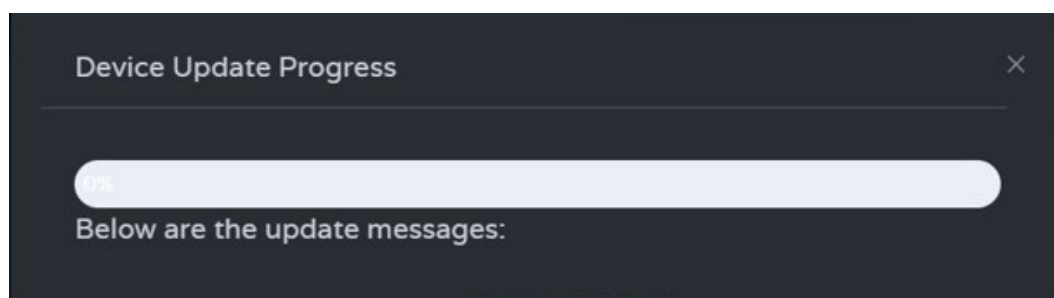

5.1.8 PASSWORD UPDATE

This page allows to **change the password**.

! Please note that **after changing**, it will skip to the Web browser home page or the Web GUI login interface automatically. **You need to log in the Web GUI again with the new password.**

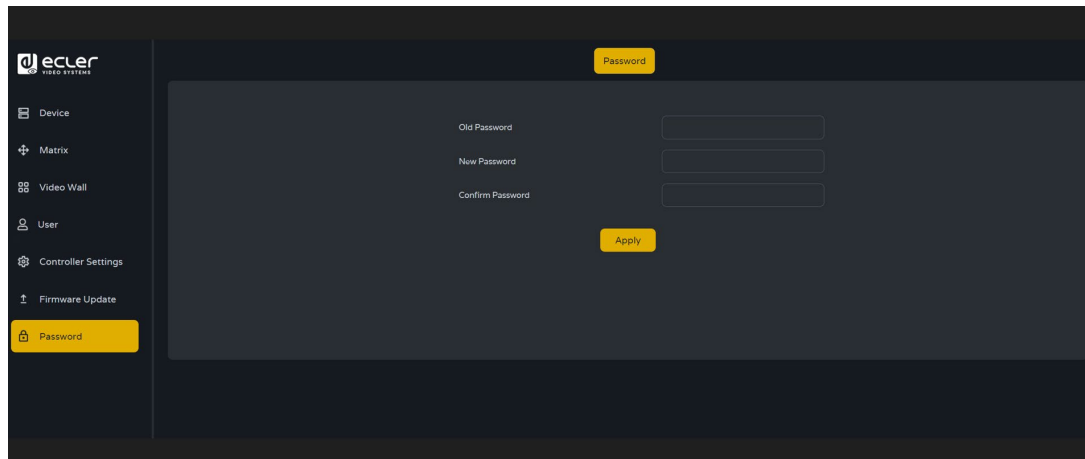

5.1.9 LOG OUT

This parameter  will allow the user to sign out of the Web Gui interface.

PRECAUTIONS
PACKAGE CONTENTS
DESCRIPTION & FEATURES
INSTALL & CONNECT
START-UP & OPERATION
PANEL FUNCTIONS
TECHNICAL DATA

6. PANEL FUNCTIONS

6.1 FRONT PANEL



1. **RESET Button:** Press and hold this button (about 10 seconds) until Status LED starts flashing: the controller will be reset automatically.
2. **POWER LED:** The red LED will light on when the controller is powered on.
3. **STATUS LED:** The status LED will flash in yellow-green every 1 second until the controller boots up is complete and Control LAN is ready, then it becomes solid green.

6.2 REAR PANEL

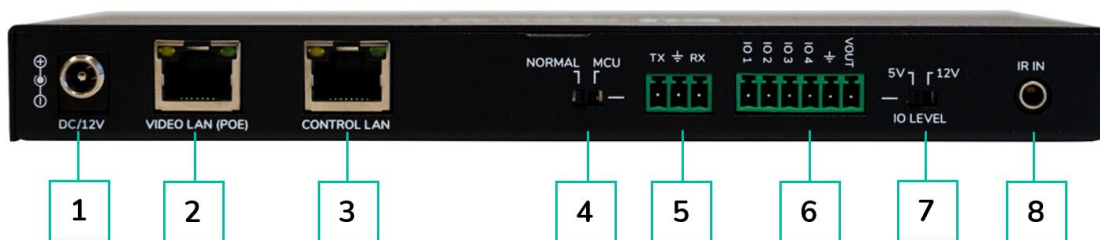

1. **DC 12V:** DC 12V/1A power input port.
2. **VIDEO LAN (POE):** 100Mbps Video LAN port, supporting POE function.

 When POE is enabled, DC 12V/1A power supply is not required.
3. **CONTROL LAN:** 100Mbps LAN control port.
4. **MCU/NORMAL DIP Switch:**
 - Normal mode (Default): The RS-232 port is used for serial port commands control.
 - MCU mode: The RS-232 port is used for MCU software upgrade.
5. **RS-232 Port:** Serial Communication Port
6. **GPIO Port:** 4 channel I/O level outputs, 1 channel grounding, 1 channel power supply to the outside (reserved for future upgrades).
7. **I/O LEVEL Switch:** Used to control I/O level output and VOUT voltage (reserved for future upgrades).
 - Switch to left: 5V I/O level output, VOUT is 5V
 - Switch to right: 12V I/O level output, VOUT is 12V.
8. **IR Input:** 12V IR Input port (reserved for future upgrades).

HOME	PRECAUTIONS	PACKAGE CONTENTS	DESCRIPTION & FEATURES	INSTALL & CONNECT	START-UP & OPERATION	PANEL FUNCTIONS	TECHNICAL DATA
------	-------------	------------------	------------------------	-------------------	----------------------	-----------------	----------------

7. TECHNICAL DATA

7.1 TECHNICAL SPECIFICATIONS

VEO-XCTRLG2

DEVICE CONTROL	
Control Connectors	RJ-45, Euroblock, Jack 3.5mm
Control Protocols	Web, TCP, RS-232
Status Indicators	Power LED (Red), Status LED (Green)
PASS-THROUGH CONTROL	
Pass-through Connectors	Euroblock, Jack 3.5mm
Pass-through Protocols	RS-232
NETWORK	
Network Connectors	2 x RJ-45
Network Requirements	IGMP Snooping
Average Streaming Bitrate	Configurable via software 1-20 Mbps
Transmission Distance	100m via Ethernet
ELECTRICAL	
Power Supply	PoE (802.3af Class 3) or External Power supply
AC Mains Connector	100-240VAC 50-60Hz with EU, UK, US, AU blades
DC Mains Connector	12VDC-1A with coaxial DC connector
Power Consumption	4.5 W
PHYSICAL	
Operating Temperature	Min: 0°C; 32°F Max: 40°C; 104°F
Operating Humidity	<90% HR
Installation Options	Desktop
Included Accessories	<ul style="list-style-type: none"> ▪ 2x 3pins Euroblock connector ▪ 4x M3 screws 4mm ▪ 2x Mounting Ears ▪ 1x 12V PSU
Optional Accessories	VEO-RACK19
Dimensions (W x H x D)	204 x 21.5 x 98,5 mm (8.03 x 0.85 x 3.88 in.
Shipping Dimensions (W x H x D)	257 x 78 x 159 mm / 10.12 x 30.07 x 6.26 in.
Weight	0.540 Kg. / 1.19 lb
Shipping Weight	0.95 Kg / 0.21 lb
Chassis Material	Metal
Finished Colour	Black



PRECAUTIONS

PACKAGE CONTENTS

DESCRIPTION & FEATURES

INSTALL & CONNECT

START-UP & OPERATION

PANEL FUNCTIONS

TECHNICAL DATA



PRECAUTIONS

PACKAGE
CONTENTS

DESCRIPTION
&
FEATURES

INSTALL
&
CONNECT

START-UP
&
OPERATION

PANEL
FUNCTIONS

TECHNICAL
DATA



All product characteristics are subject to variation due to production tolerances. **NEEC AUDIO BARCELONA S.L.** reserves the right to make changes or improvements in the design or manufacturing that may affect these product specifications.

For technical queries contact your supplier, distributor or complete the contact form on our website, in [Support / Technical requests](#).

Motors, 166-168 -08038 Barcelona - Spain-(+34) 932238403 | information@ecler.com | www.ecler.com