

HUB Series

DIGITAL MATRIX

Digital zoner with DSP



HANGAR
HUB SERIES WEB APP



PILOT
HUB SERIES CONTROL APP

USER MANUAL

INDEX

HARDWARE.....	6-39
1. IMPORTANT REMARK.....	6
2. IMPORTANT SAFETY INSTRUCTIONS	6
3. IMPORTANT NOTE.....	8
4. INTRODUCTION.....	8
5. INSTALLATION AND CONNECTION	11
5.1. Location, mounting and ventilation	11
5.2. Mains connection and power on.....	11
5.3. Local audio input connections.....	12
5.4. Remote Audio Input Connections	14
5.5. Connections PAGER A, PAGER B and priority PAGER / DUCKER modules	15
5.6. REMOTE INPUTS 1 to 8 Connections	16
5.7. Remote ports, RJ45 interface pins	17
5.8. Output Audio Connections.....	18
5.9. ETHERNET and RS-232 programming and control ports	19
5.10. MUTE port.....	20
6. CONFIGURATION AND CONTROL	21
6.1. Configuration via embedded web application	21
6.2. Operation from the front panel	24
7. FUNCTION LIST	28
8. FUNCTION DIAGRAM.....	29
9. BLOCKS DIAGRAM.....	30
9.1. HUB1408.....	30
9.2. HUB1616.....	31
10. TECHNICAL FEATURES	32
10.1 HUB1408	32
10.2 HUB1616.....	36
SOFTWARE	
* HANGAR & PILOT: Software and control App for HUB series.....	40-124
11. HANGAR & PILOT INTRODUCTION	41
11.1. VERSIONS	41

11.2. PUBLISHING NOTES	41
11.3. LIST OF COMPATIBLE DEVICES	41
12. FIRST STEPS	42
12.1. AUTOMATIC CONNECTION.....	42
12.2. MANUAL CONNECTION.....	44
13. ACCESS TO THE WEB APPLICATION HANGAR.....	45
14. CONFIGURATION	47
14.1. NETWORK CONFIGURATION.....	50
14.2. DEVICE STATUS.....	52
14.3. HUB SETUP FILE	53
14.4. PREDEFINED SETUPS.....	55
14.5. BOOT UP MODE.....	56
15. USERS	57
15.1. EDIT PUBLIC PROFILE	59
15.2. CHANGE ADMINISTRATOR PASSWORD.....	60
16. FRONT PANEL.....	61
16.1. ALLOWED CONTROLS.....	61
16.2. GLOBAL PANEL LOCK.....	62
16.3. LCD SETTINGS.....	63
17. INPUTS	64
17.1. CHANGE LABEL	68
17.2. STEREO	69
17.3. FREQUENCY SHIFTER	70
17.4. POLARITY.....	71
17.5. HPF	72
17.6. GATE	73
18. OUTPUTS.....	74
18.1. STEREO	76
18.2. EXTERNAL MUTE EN.....	77
18.3. DELAY	78
18.4. X-OVER	78
18.5. GEQ.....	79
18.6. COMP	80
18.7. PANIC.....	81

19. GENERAL VOLUME	82
20. PAGERS/DUCKERS	83
20.1. DUCKERS.....	83
20.1. PAGERS.....	85
21. REMOTE CONTROL PANELS.....	87
22. PILOT PANELS	90
22.1. STATUS.....	92
22.2. OPTIONS.....	92
22.3. GENERAL.....	94
22.4. VOLUME CONTROL.....	94
22.5. SOURCE SELECTION.....	95
22.6. EQUALIZER	96
22.7. COLOR.....	96
22.8. IMAGE	97
22.9. PILOT PANELS EXAMPLES	99
23. HELP	104
24. ACCESS TO PUBLIC PILOT PANELS.....	105
25. ACCESS TO THE WEB APP AS A USER	106
26. ECLER PILOT.....	108
26.1. ADDING A DEVICE.....	109
26.2. ACCESSING THE CONTROL PANELS.....	112
26.3. LOADING DEFAULT SETTINGS.....	114
26.4. DEMO MODE	116
27. APPENDIX.....	117
27.1. PREDEFINED SETUPS HUB1616.....	117
27.1.1. Factory setup / 16 ZONES MONO – 2 SOURCES	117
27.1.2. 16 ZONES MONO – 4 SOURCES.....	118
27.1.3. 8 ZONES STEREO – 4 SOURCES.....	119
27.1.4. 8 ZONES STEREO – 6 SOURCES.....	120
27.2. PREDEFINED SETUPS HUB1408.....	121
27.2.1. Factory setup / 8 ZONES MONO – 2 SOURCES	121
27.2.2. 8 ZONES MONO – 3 SOURCES	122
27.2.3. 8 ZONES MONO – 4 SOURCES	122

27.2.4. 4 ZONES STEREO – 3 SOURCES 123

27.3. RESTORE DEFAULTS 123

*** PROTOCOLO TP-NET (Third-Party NET).....125-137**

28. TP-NET PROTOCOL INTRODUCTION 125

29. HUB SERIES DIGITAL ZONER 128

30. HUB SERIES ERROR CODES 136

1. IMPORTANT REMARK



WARNING: SHOCK HAZARD - DO NOT OPEN
AVIS: RISQUE DE CHOC ÉLECTRIQUE - NE PAS OUVRIR



The lightning flash with arrowhead symbol, within an equilateral triangle, is intended to alert the user to the presence of uninsulated “dangerous voltage” within the product’s enclosure that may be of sufficient magnitude to constitute a risk of electric shock to persons.



The exclamation point within an equilateral triangle is intended to alert the user to the presence of important operating and maintenance (servicing) instructions in the literature accompanying the appliance.

WARNING (If applicable): The terminals marked with symbol of “” may be of sufficient magnitude to constitute a risk of electric shock. The external wiring connected to the terminals requires installation by an instructed person or the use of ready-made leads or cords.

WARNING: To prevent fire or shock hazard, do not expose this equipment to rain or moisture.

WARNING: An apparatus with Class I construction shall be connected to a mains socket-outlet with a protective earthing connection.

2. IMPORTANT SAFETY INSTRUCTIONS

1. Read these instructions.
2. Keep these instructions.
3. Heed all warnings.
4. Follow all instructions.
5. Do not use this apparatus near water.
6. Clean only with dry cloth.
7. Do not block any ventilation openings. Install in accordance with the manufacturer’s instructions.
8. Do not install near any heat sources such as radiators, heat registers, stoves, or other apparatus (including amplifiers) that produce heat.

9. Do not defeat the safety purpose of the polarized or grounding type plug. A polarized plug has two blades with one wider than the other. A grounding type plug has two blades and a third grounding prong. The wide blade or the third prong are provided for your safety. If the provided plug does not fit into your outlet, consult an electrician for replacement of the obsolete outlet.
10. Protect the power cord from being walked on or pinched particularly at the plugs, convenience receptacles, and at the point where they exit from the apparatus.
11. Only use attachments/accessories specified by the manufacturer.
12. Unplug the apparatus during lightening sorts or when unused for long periods of time.
13. Refer all servicing to qualified personnel. Servicing is required when the apparatus has been damaged in any way, such as power supply cord or plug is damaged, liquid has been spilled or objects have fallen into the apparatus, the apparatus has been exposed to rain or moisture, does not operate normally, or has been dropped.
14. Disconnecting from mains: Switching off the POWER switch all the functions and light indicators of the amplifier will be stopped, but fully disconnecting the device from mains is done unplugging the power cord from the mains input socket. For this reason, it always shall remain readily operable.
15. Equipment is connected to a socket-outlet with earthing connection by means of a power cord.
16. The marking information is located at the bottom of apparatus.
17. The apparatus shall not be exposed to dripping or splashing and that no objects filled with liquids, such as vases, shall be placed on apparatus.
18. This product is for indoor use only.

NOTE: This equipment has been tested and found to comply with the limits for a Class A digital device, pursuant to part 15 of the FCC Rules. These limits are designed to provide reasonable protection against harmful interference when the equipment is operated in a commercial environment. This equipment generates, uses, and can radiate radio frequency energy and, if not installed and used in accordance with the instruction manual, may cause harmful interference to radio communications. Operation of this equipment in a residential area is likely to cause harmful interference in which case the user will be required to correct the interference at his own expense.



WARNING: This product must not be discarded, under any circumstance, as unsorted urban waste. Take to the nearest electrical and electronic waste treatment centre.

NEEC AUDIO BARCELONA, S.L. accepts no liability for any damage that may be caused to people, animal or objects due to failure to comply with the warnings above.

3. IMPORTANT NOTE

Thank you for choosing our **digital zoner with DSP HUB1408 / HUB1616!**

It is **VERY IMPORTANT** to carefully read this manual and to fully understand its contents before any connection in order to maximize your use and get the best performance from this equipment.

To ensure optimal operation of this device, we strongly recommend that its maintenance be carried out by our authorized Technical Services.

All ECLER products are covered by warranty, please refer to www.ecler.com or the warranty card included with this product for the period of validity and conditions.

4. INTRODUCTION

HUB1408/HUB1616 is a zone manager with multiple inputs and outputs, an evolution of its predecessor eMIMO1616. It has the HANGAR embedded web-server application (control from standard web browser in Windows / MacOS, etc.) for its configuration; remote control from physical wall installation panels, call (paging) stations and applications for mobile devices (Android, iOS). Includes DSP with specific functions for both inputs and outputs.

HUB Series offers multiple possibilities, being intuitive and easy to configure. From the least experienced user to the most expert, you can set up a professional audio installation in a matter of minutes (Plug & Play). It is the perfect solution for any type of sound that requires managing and controlling different zones.

Main features:

- Local stereo audio inputs: 4x HUB1616 inputs (INPUT1-4), 2x HUB1408 inputs (INPUT1-2). Compatible with line level and gain adjustment from -5 to +15 dB. 2xRCA and Euroblock connectors on rear panel.
- Local mono audio inputs: 4x HUB1616 inputs (INPUT5-8), 4x HUB1408 inputs (INPUT3-6). Microphone and line level compatible, gain adjustment from 0 to +50 dB. Euroblock connectors on rear panel. Software configurable to 2 stereo inputs.
- 8 remote balanced mono audio inputs, compatible with line level. Available on rear panel RJ45 connectors (REMOTE INPUT1-8)
- 2 local PAGER inputs (A and B), compatible with eMPAGE type call stations, receiving the signal from their microphone. RJ45 connectors on the rear panel: HUB1616: INPUT 7 and INPUT 8; HUB1408: INPUT 5 and 6.INPUT 6
- Audio output channels (zone outputs) 16x HUB1616 outputs, 8x HUB1408 outputs. Line level, balanced and independently configurable as:
 - mono outputs (1 channel per output)

- stereo outputs (2 channels per output, natural pairs 1-2, 3-4, 5-6, etc.)
- 1 headphone audio output for output zone MONITOR function, mini-jack connector and front panel volume control
- 8 REMOTE ports for the connection of digital remote panels type eMCONTROL1, with wall format RJ45 connectors on the rear panel
- Ethernet interface with RJ45 connector, for programming and remote control of the unit by means of integrated HANGAR web application (embedded web-server) and/or TP-NET protocol for integration with third parties
- DHCP (factory setting) and static IP modes
- RS-232 interface with DB9 connector, for remote control of the unit via TP-NET protocol for integration with third parties
- MUTE port for muting one or more zone outputs by means of external potential-free contact closure.
- Meter sets for displaying output signals (zones) from the front panel.
- SELECT / MUTE key for each zone output on the front panel.
- LCD display, CONTROL key (CTRL) and digital rotary control (encoder) for control of the unit's zone outputs from the front panel.
- DATA (connection from external client devices) and ON indicators on the front panel
- Processing available in inputs:
 - 3-tone equalization adjustment via BASS-MID-TREBLE controls
 - Volume adjustment and MUTE control
 - Phase inversion
 - Stereo: Allows balanced audio inputs to be configured in stereo pairs. Available on local inputs INPUT5-8 on HUB1616, INPUT3-6 on HUB1408
 - Frequency shifter available for the microphone inputs: local inputs INPUT5-8 on HUB1616, INPUT3-6 on HUB1408
 - Noise gate: available on local inputs INPUT5-8 on HUB1616, INPUT3-6 on HUB1408.
 - High-pass filter: with adjustable frequency available on local inputs INPUT5-8 on HUB1616, INPUT3-6 on HUB1408
 - Audio over audio priority function, with 4 levels and volume control independent from the 4 (from -40dB to +6dB): inputs 5 to 8 MIC/LINE on HUB1616, inputs 3 to 6 on HUB1408, can attenuate (or totally mute) the sound content present (program audio) in certain target areas, enabling the broadcasting of emergency messages, warnings, etc. Each of the above inputs can exercise this function with priority 1 (higher) or 4 (lower). Priority function activation modes can be:
 - DUCKER, by audio signal detection: when a valid signal is received and as long as it persists in the input in question. Available on local inputs 5 to 8 on HUB1616, local inputs 3 to 6 on HUB1408
 - PAGER: by selection of destination zones, pressing the PAGE key and voice announcing in real time from eMPAGE type call stations.

Chime tone available to be triggered prior to message voicing by activating the PAGE function. Available on local inputs 7 and 8 on HUB1616, local inputs 5 and 6 on HUB1408 (PAGER A and PAGER B, respectively)

- Processing available in outputs:
 - Mono mode (outputs managed individually) or stereo mode (areas managed in natural pairs: 1-2, 3-4, etc.). Automatic management of mono or stereo audio sources routed to mono or stereo outputs.
 - Program source selection (local or remote audio inputs)
 - 3-tone equalization adjustment via BASS-MID-TREBLE controls
 - Volume adjustment and MUTE control
 - Limitation of the range of available output volume (minimum and maximum levels) to the end user, from any control method (eMCONTROL1 panels, pilot application clients, etc.)
 - Phase inversion
 - Enablement for silencing via rear panel MUTE port (via external contact closure)
 - Delay setting: available for zone outputs 1 to 8 on HUB1616, all zone outputs on HUB1408
 - Crossover filter: Filter-low-pass (LPF) or filter-high-pass (HPF) setting with cut-off frequency adjustment Available for zone outputs 1 to 8 on HUB1616, all zone outputs on HUB1408.
 - 8-band graphic equalizer.
 - 8-band graphic equalizer. Available on all zone outputs on both models
 - Compressor/limiter available on all zone outputs on both models
- General Volume: general volume control, of all outputs or a selection of them
- Programming and control as an Administrator (**admin**) user from the **HANGAR embedded web application**, using a computer, tablet or mobile device and a standard web browser (no dedicated software installation)
- Remote control of end users by:
 - Front panel control, with configurable access restrictions
 - eMCONTROL1-type physical wall panels
 - eMPAGE-type paging stations
 - **Ecler pilot** application, available for iOS and Android client devices
 - Standard web browsers, from computers, tablets, etc.

- Predefined setups: default settings (templates) accessible from the web server and from the Ecler pilot app

Note: from the unit's embedded web application, HANGAR, the **admin** user configures the restrictions of the controls and settings available from the front panel and from the physical wall panels (eMCONTROL1) and call stations (eMPAGE) for the end user, as well as the user accounts and graphic control panels and settings that the end customers of the **Ecler pilot** and web applications will be able to handle.

5. INSTALLATION AND CONNECTION

5.1. Location, mounting and ventilation

HUB1616/ HUB1408 has been specially designed to be placed in 19" rack structure, occupying two units.

It is very important that, as a heat generating element, the unit is not completely enclosed or exposed to extreme temperatures. Fresh air should be allowed to pass through the ventilation holes in the chassis, leaving at least one free rack unit between each piece of equipment and those installed above and below it in the rack frame.

If the installation consists of several units in the same rack or is carried out inside cabinets closed by means of doors, it is highly recommendable to equip them with forced upward ventilation, installing fans at their lower and upper ends. This upward flow of ventilation will favor the dissipation of the heat generated in its interior.

5.2. Mains connection and power on

HUB1616/ HUB1408 operates on alternating voltages from 90 to 264V and 47 to 63Hz. This device is equipped with an oversized power supply capable of adapting without any type of adjustment to the mains voltage of any country in the world.

On the rear panel, next to the IEC power connector, there is an on/off switch for the unit. On the front panel there is a LED **ON** indicator that illuminates when the unit is in operation.

Do not allow the network cable to run parallel to the shielded cables carrying the audio signal, as this may cause humming.

5.3. Local audio input connections

HUB1616 has 8 local audio inputs on its rear panel, HUB1408 has 6 local inputs, with the following types of connections available:

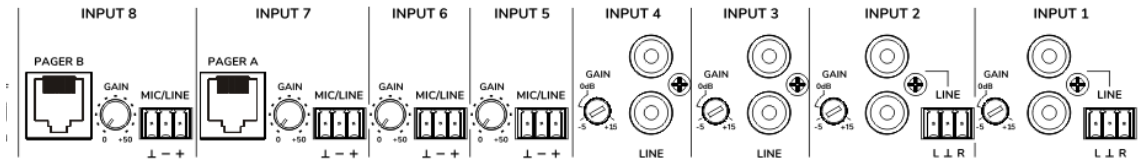

Figure 1: HUB1616 local inputs

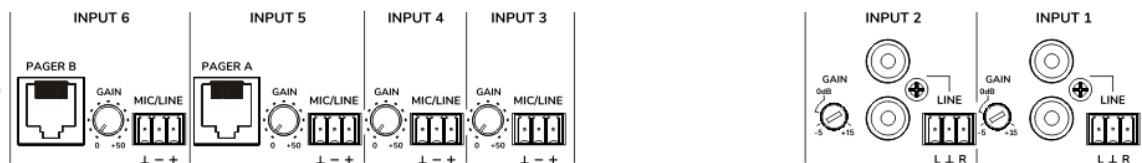

Figure 2: HUB1408 local inputs

- **HUB1616:** INPUT1 to INPUT4; **HUB1408:** INPUT1 and INPUT2: **unbalanced stereo line** signals with double connector format (RCA and Euroblock). Use one or the other connector, depending on the type of wiring available between your sound source and the HUB unit:
 - Dual RCA Connector: Connect your stereo sound source (CD players, Smartphones, radio tuners, streaming players, etc.) directly using a cable that delivers the left (L) and right (R) channels to the unit's white and red RCA connectors, respectively.
 - Euroblock connector, 3-pin: connect your stereo sound source this way:
 - Left channel > Terminal L
 - Right channel > Terminal R
 - Ground > Terminal ⊥
- **HUB1616:** INPUT5 to INPUT8; **HUB1408:** INPUT3 to INPUT6: Microphone or line signals, **mono and balanced**, with 3-pin Euroblock connector:
 - Live or direct signal > Terminal +
 - Cold or inverted signal > Terminal -
 - Ground > Terminal ⊥

Note: If your sound source is stereo, and you want to connect it to one of the local inputs IN5 to IN8 of the HUB1616 unit (local inputs IN3 to IN6 in HUB1408), mono and balanced, you can do it by means of the following stereo to mono conversion, only using a pair of external resistors:

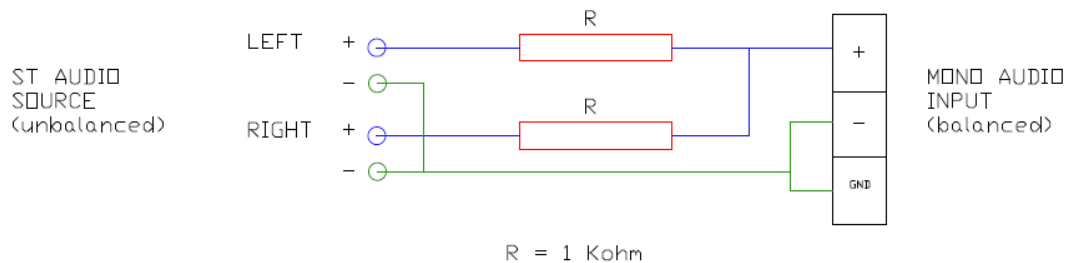

Figure 3: stereo to mono conversion

On the rear panel of the unit there is a PHANTOM ON/OFF switch, which provides phantom power to inputs 5 to 8 on the HUB1616, inputs 3 to 6 on the HUB1408, for use with microphones that require it, usually condenser microphones.

- Additionally, there are 2 connection ports called PAGER A and PAGER B, with audio inputs INPUT7 and INPUT8 (respectively) on HUB1616, inputs INPUT5 and INPUT6 on HUB1408, duplicated for use with PAGER priority modules). These ports receive audio signals from eMPAGE type call stations. A standard CAT5 cable (uncrossed) or higher, with RJ45 connector on both ends, connects a calling station point to one of the unit's A or B ports, running through it the station's remote DC power, control data and balanced audio picked up by the station's microphone. The maximum number of stations allowed is 2: one connected to port PAGER A and/or the other to port PAGER B.

Once the physical connection of the different audio inputs has been made, it will be necessary to act on the GAIN controls of each one of them to obtain an optimum signal intensity and maximum signal/noise ratio, so that they can be used correctly as sound sources in the installation. Try to maximize the volume controls of the audio players before adjusting the gain in the HUB unit. Use the level indicators on the front of the unit (physical VU meters), as well as the virtual level indicators (on-screen VU meters) of the HANGAR web application for the correct gain adjustment, trying to work normally with signal peaks in the area close to 0 dB (orange area in the virtual VU meters) and very exceptionally above it ("red", saturation or clip area).

5.4. Remote Audio Input Connections

The HUB1616 / HUB1408 has 8 control ports (REMOTE INPUTS) with RJ45 connector, for the connection of eMCONTROL1 type remote control panels. Each of these ports, besides providing DC power and establishing the digital communication bus with the remote panels, has a mono audio input, balanced and with line level, considered a **remote input** of the HUB unit. In this way, it is possible to expand the number of audio inputs of the equipment with these 8 remote inputs, in addition to the local inputs available through audio connectors on the rear panel of the matrix.

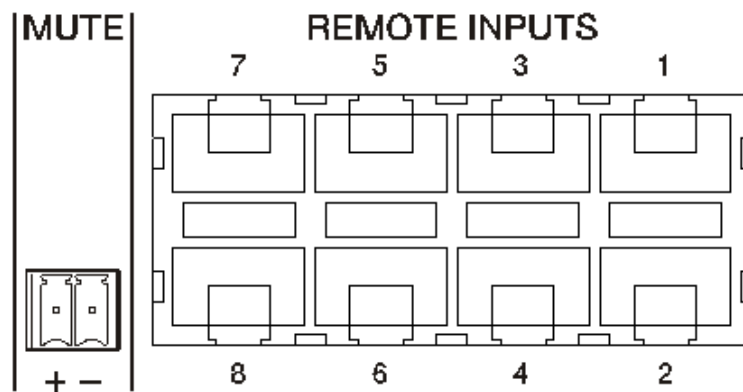
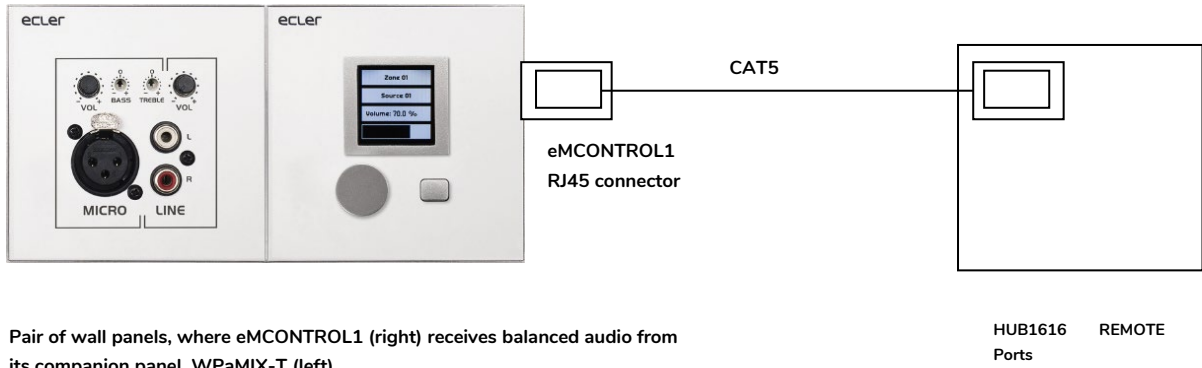

Figure 4: remote inputs (wall control panels)

Connecting a balanced mono audio signal to a REMOTE port of a HUB device is done as follows:

- Live or direct signal > Terminal 1 of the RJ45 connector
- Cold or inverted signal > Terminal 2 of RJ45 connector
- Ground > Terminal 3 of RJ45 connector

If an eMCONTROL1 type remote panel is used to control an area of the installation, the eMCONTROL1 panel itself has an internal connector to receive the audio signal from an adjacent and complementary panel, such as the WPaMIX-T in the pair of the example below. This type of configuration is ideal to have zone control and remote audio from the zone itself: a single standard CAT5 cable, connected between the eMCONTROL1 panel and a REMOTE port of the HUB unit, is used to carry out the exchange of DC power, digital control data and remote audio signal, physically entered in the eMCONTROL1 complementary panel, to the HUB unit.



Pair of wall panels, where eMCONTROL1 (right) receives balanced audio from its companion panel, WPaMIX-T (left)

Figure 5: WPaMIX-T and eMCONTROL1 mounting

5.5. Connections PAGER A, PAGER B and priority PAGER / DUCKER modules

In the local input section of the rear panel there are 2 connection ports called PAGER A and PAGER B, whose audio inputs correspond internally to the INPUT 7 and INPUT 8 inputs (respectively) on the HUB1616, INPUT5 and INPUT6 on the HUB1408.

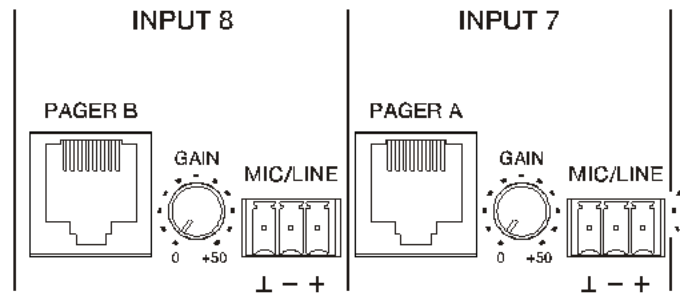

Figure 6: PAGER/DUCKER ports on HUB1616

The PAGER ports are used for point-to-point connection to eMPAGE-type call stations, through which it is possible to carry out real-time voice call (paging) actions to exit areas of the installation, using a priority module of the HUB unit that attenuates or completely silences the sound content of the program existing in these areas at the time of the action.

A standard CAT5 cable (uncrossed) or higher, with RJ45 connector on both ends, connects a calling station point to one of the unit's A or B ports, running through it the station's remote DC power, control data and balanced audio picked up by the station's microphone.

The maximum number of stations allowed is 2: one connected to the PAGER A port and/or the other to the PAGER B port, each using a PAGER priority module in the HUB unit.

Note: The following connections cannot be made simultaneously, as they are **exclusive**:

- a call station to the PAGER A port + an audio signal to the Euroblock connector of the INPUT7 input on the HUB1616, INPUT5 on the HUB1408
- a call station to the PAGER B port + an audio signal to the Euroblock connector of the INPUT8 on HUB1616, INPUT6 on HUB1408

The total number of PAGER (with call station) or DUCKER (without call station) priority modules in a HUB device is 4, assignable to local inputs 5 to 8 in HUB1616, local inputs 3 to 6 in HUB1408. These 4 modules can be activated or not, and each of them can use one of the 4 priority levels available, so that the signals with higher priority will attenuate the program signal selected in the destination zones and also the signals with lower priority sent to those zones, if they exist, when the module with maximum priority is activated.

Refer to the [HANGAR web application manual](#) for programming the PAGER / DUCKER priority modules.

5.6. REMOTE INPUTS 1 to 8 Connections

On the rear panel of a HUB device there are 8 control ports, REMOTE INPUTS 1 to 8, enabled for the connection of eMCONTROL1 type zone control wall panels. Each port has an RJ45 type connector, and each eMCONTROL1 type panel also has an RJ45 connector, so that the physical connection between a remote panel and a REMOTE port of the HUB unit is made, point to point, by means of a standard CAT5 or higher type cable (not crossed).

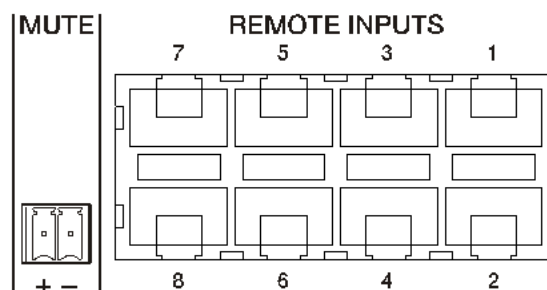

Figure 7: remote audio inputs

This physical connection provides DC power to the remote panel from the HUB unit and establishes the digital communication bus between the two units. It also implements balanced mono audio reception from a potential remote sound source (connected on the side of the control panel) in the HUB unit.

The control wall panels are configured by the user Administrator through the HANGAR web application ([see HANGAR web application manual](#)), so it is possible to disable them completely or to enable them to act as user control for a zone of the installation, including all or some of the following functions:

- Sound source selection (program audio), from a customized list for each panel that includes some local sources and/or the remote source itself.
- Volume adjustment (with maximum and minimum operating range) and mute control
- Equalization adjustment, with 3-tone control (BASS-MID-TREBLE)

Alternatively, these inputs can only receive a balanced mono audio signal via the RJ-45 connector, respecting the corresponding pin assignment ([see section 5.4](#)):

- Ground > Pin 3 of the RJ45 connector
- Cold or inverted signal > Pin 2 of RJ45 connector
- Live or direct signal > Pin 1 of RJ45 connector

5.7. Remote ports, RJ45 interface pins

- **Pin 1:** audio hot or direct signal
- **Pin 2:** audio cold or inverted signal
- **Pin 3:** ground
- **Pins 4 & 5:** digital data bus
- **Pin 6:** 12 VDC supply
- **Pin 7:** unused
- **Pin 8:** ground

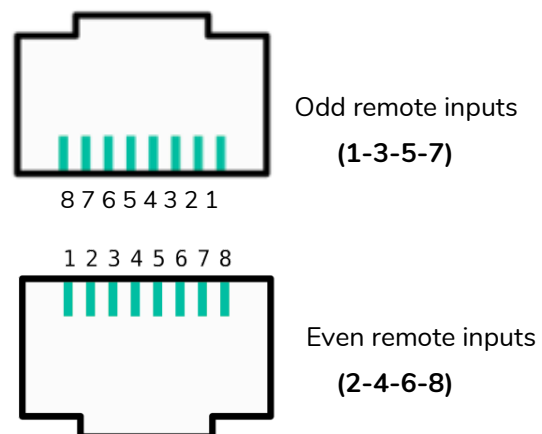

5.8. Output Audio Connections

HUB1616 has 16 audio output channels (zone outputs), 8 in HUB1408, with line level, balanced and independently configurable as:

- mono outputs (1 channel per output)
- stereo outputs (2 channels per output, natural pairs 1-2, 3-4, 5-6, etc.)

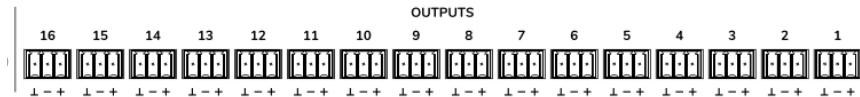

Figure 8: HUB1616 zone outputs

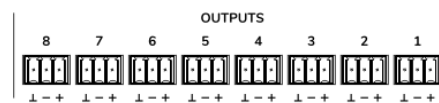

Figure 9: HUB1408 zone outputs

Each output has a 3-pin Euroblock connector, with the following layout:

- Live or direct signal > Terminal +
- Cold or inverted signal > Terminal -
- Ground > Terminal ⊥

If an output channel is connected to an amplifier or audio device with a **balanced** input, the + and - ⊥ terminals must be connected point by point and between the two devices. When connecting an output channel to an amplifier or device with an **unbalanced** audio input, leave the - terminal unconnected.

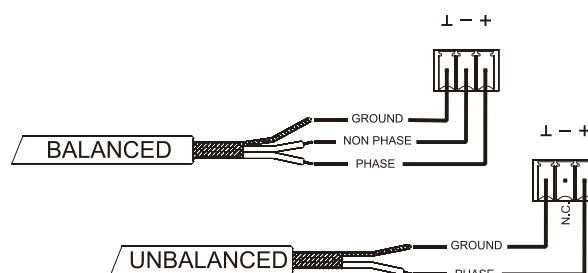

Figure 10: balanced audio output connection

MONITOR OUTPUT (marked with headphone symbol): 3.5mm stereo mini-jack connector with a rotary level control for headphone listening. It is especially useful for listening to the unit's output signals without disturbing its normal operation. The selection of the signal to listen to is made through the front panel, simply by pressing the “select” button of the zone you want to monitor. The headphone volume control is located after the zone volume control and after the general volume control (GENERAL VOLUME), so you should consider the zone volume and the general volume or, if the zone or general volume control is set to MUTE.

5.9. ETHERNET and RS-232 programming and control ports

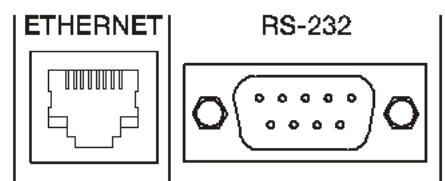

Figure 11: control ports

The RJ45-type ETHERNET connector on the rear panel allows the equipment to be connected to an Ethernet network, or directly to a computer or other device with an Ethernet interface, point-to-point. This connection enables, within a local network, the following:

- Global programming and management of the HUB unit using the HANGAR embedded web application and a standard web browser running on a computer, tablet, etc.
- Connection of client devices for end-user management of areas of the installation through the **Ecler pilot** application, compatible with Android and iOS, or through standard web browsers running on computers, tablets, etc.
- Connection of third-party devices for integration in control systems (Crestron®, Extron®, AMX®, Vity®, Medialon®, etc., registered trademarks by their manufacturers), using the TP-NET protocol embedded in the HUB devices. Refer to the [TP-NET protocol manual](#) for more information.

The RS-232 type DB9 connector on the rear panel allows the connection of the point-to-point equipment to a computer or other control device. This connection is used only for serial port integration with third party equipment and control systems (Crestron®, Extron®, AMX®, Vity®, Medialon®, etc., registered trademarks of their manufacturers) using the TP-NET protocol embedded in HUB devices. Refer to the [TP-NET protocol manual](#) for more information.

The parameters required for a correct serial connection are as follows:

- Baud rate: 115200 (fixed, no auto negotiation)
- Data bits: 8
- Parity: None
- Stop bits: 1
- Flow control: None

5.10. MUTE port

The HUB1616 / HUB1408 has on its rear panel a control input, or MUTE port (Normally Open = MUTE OFF / Closed = MUTE ON), which allows the activation / deactivation of the mute of audio outputs (zones) of the unit by means of a push button, relay or external potential free contact closure.

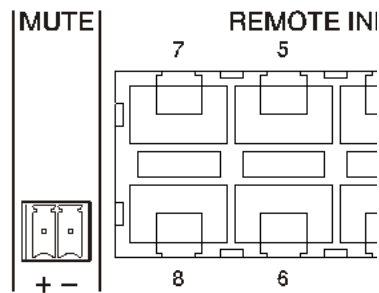

Figure 12: MUTE port

The assignment of outputs affected by the MUTE port is configured from the HANGAR web application. Refer to the [HANGAR web application manual](#) for more information.

6. CONFIGURATION AND CONTROL

6.1. Configuration via embedded web application

Once the physical connections have been made, the HUB unit must be configured using the integrated web application: HANGAR. It has to be configured from a computer, Tablet or similar where a standard web browser is running, pointing to the unit's IP address, which can be modified. This task is reserved exclusively for the installer or system administrator, who must identify himself with his “**admin**” user credentials:

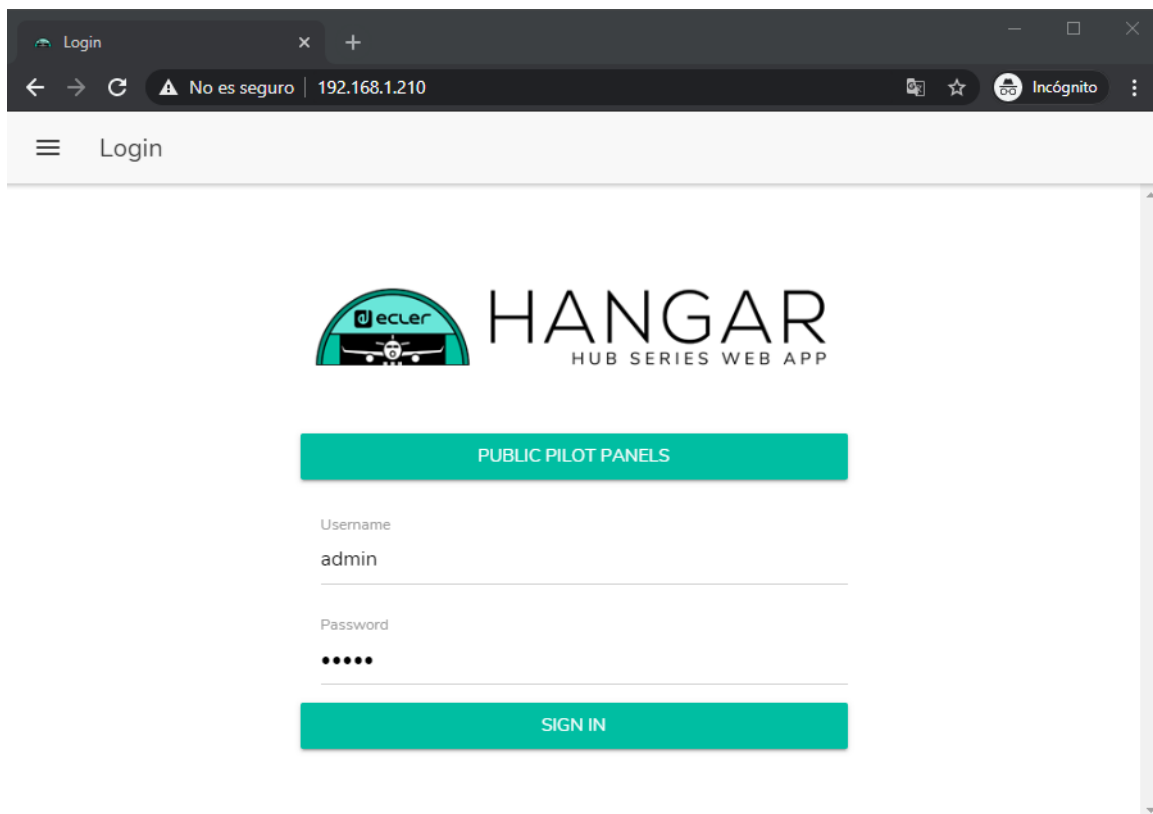

Figure 13: HANGAR, web application for configuration and control of HUB devices

Refer to the [HANGAR web application manual](#) for complete information about configuring your computer using the built-in web server.

By default, the network configuration is in DHCP mode (dynamic IP address assignment). Connection to a router/switch with DHCP server is required. To query the IP assigned to the device, press and hold the CTRL and rotary encoder keys simultaneously for 3 seconds.

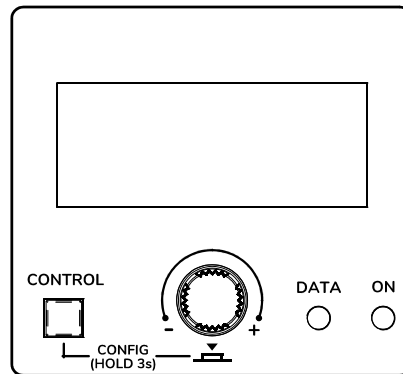

Figure 14: front panel LCD display and control keys

Note: HUB devices use the mDNS service to access them through a web browser on the same local network (LAN). To do this, enter in the search bar of your browser: device_name.local. By default, “hub1616.local” in HUB1616, “hub1408.local” in HUB1408.

The configuration screen (CONFIG) shows the following information:

- Firmware version running on the unit
- NAME: name of the HUB unit
- Network connection parameters: IP address, subnet mask and network gateway
- Auto/Manual: IP assignment mode:
 - AUTO (Default device configuration): DHCP mode. The IP address assignment is automatic.
 - A DHCP server is required to assign an address.
 - MANUAL: allows the configuration of manual network parameters. Default parameters in MANUAL mode are:
 - IP: 192.168.0.100
 - MASK: 255.255.0.0
 - GW: 192.168.0.1

Note: connection to a DHCP server is necessary in order that an IP address is assigned to the HUB.

- Admin: number of admin users connected to the unit (0 or 1)
- Users: number of client users, via Ecler pilot application or web browsers (0 to 20)

The main parameters, settings and functions accessible in a HUB device from its web application are:

- General configuration: unit name, network parameters, project saving and retrieval (global device settings except network parameters), boot mode, firmware update, restore to default parameters/factory settings, connection status and default settings (*Predefined setups*).
- User accounts management, which will allow the access of external clients (final users) through the Ecler pilot application or web browsers: names, passwords and enabled/disabled status Public profile edition (access without credentials) and permission to load default settings from this profile. Edition of the administrator access password.
- Front panel parameters:
 - LCD display settings: brightness, contrast, sleep mode
 - global access/locking (of all front controls)
 - access/blocking of certain controls, and certain exit areas, on an individual basis. It is possible to allow access to the settings of some zones and to block those of others, and even to decide which parameters are accessible for each one of them: volume adjustment & MUTE and/or sound source selection and/or equalisation by means of 3-tone control (BASS-MID-TREBLE)
 - Selection of last zone or general volume. The front panel display will show the selected option after a few seconds of inactivity on the front panel.
- Local and remote audio input parameters: names, stereo mode, *frequency shifter*, polarity, volume, MUTE, equalization by 3-tone control (BASS-MID-TREBLE), noise gate and high-pass filter.
- Audio output parameters (zones): names, mono / stereo mode, polarity, sound source selection, volume, range of volume accessible to end users (minimum and maximum levels), MUTE, equalisation by 3-tone control (BASS-MID-TREBLE), delay adjustment, crossover filter (LPF / HPF), graphic equalisation, compressor/limiter and MUTE port activation assignment (external contact closure).
- General volume settings: volume, MUTE, range of volume accessible to end users (minimum and maximum levels) and selection of audio outputs (zones) that will be affected by the overall volume
- Configuration of the 4 PAGER / DUCKER priority modules (with eMPAGE type call stations / activated by audio level detection on the input in question, respectively)

- Configuration of the eMCONTROL1-type physical control panels connected to the HUB unit: connection status, enabled/disabled status, zone under its control, enabled functions (volume adjustment & MUTE and/or sound source selection and/or equalisation via 3-tone control (BASS-MID-TREBLE)), etc.
- Creation, edition and configuration of the pilot panels, accessible from external devices through the Ecler pilot application or web browsers: public or private type panel (accessible only by certain users), enabled/disabled status, area under its control, enabled functions (volume & MUTE adjustment and/or sound source selection and/or equalization through 3-tone control (BASS-MID-TREBLE)), graphic aspect (slider or rotary control types, control colors, texts and background), etc.

6.2. Operation from the front panel

Using the physical controls on the front panel of a HUB device, adjustments can be made to the different output zones of the unit. The settings available for the different zones will be those enabled by the **admin** user from the HANGAR web application, and can range from total blocking of the front panel to total freedom of control of all zones (volume adjustment, source selection and equalisation settings), to total or partial blocking of some of them.

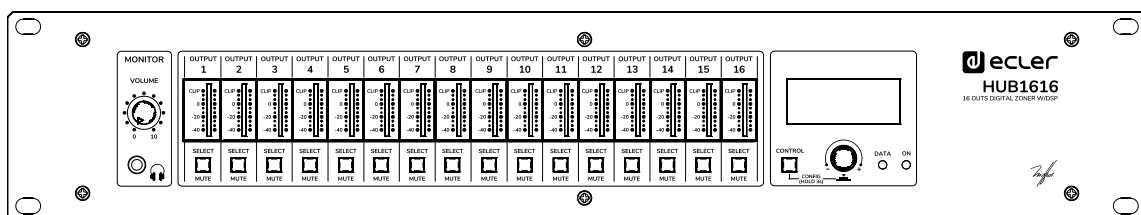

Figure 15: HUB1616 front panel

Pressing a SELECT key corresponding to one of the unit's outputs takes control of the unit using the CTRL key, the digital rotary control (hereinafter **encoder**) and the LCD display on the right-hand section of the front panel. The LED on the SELECT key will also blink at a fixed rate (long time off, short time on), indicating that the output has been selected for control. After a few seconds without acting on the front controls, i.e. without making any adjustments, this key will stop flashing. If the *General Volume* option has been selected as the default zone selection, the display will show the controls for this after a few seconds of inactivity. The HUB unit has this option enabled in the factory settings.

Example by pressing the SELECT key on output 1 or 2 (same effect in this case, as they are configured as a stereo pair):



Example by pressing the SELECT key on output 3:



In the images above you can see:

- 2 level indicators or voumeters (vertical bars): the one on the left of the screen indicates the level of the selected sound source for the selected zone (*pre-fader*), and the one on the right indicates the output signal level of this zone (*post-fader*)
- First line of text: output number (zone) selected.
- Second line of text: name (label) of the selected area
- SRC: selected sound source
- VOL: adjusted output volume

The flashing box over SRC or VOL, plus the line of text on light background and dark text, indicates which function is currently **in focus**, or ready for adjustment. The image below is of the VOL control, which allows the output volume to be adjusted by the encoder, and within the predefined range (by the user **admin**) for the selected output:



In this screen, a long press (>3 seconds) on the encoder, or a long press of a SELECT key activates / deactivates the MUTE function of the zone in question:



Note: about the muted outputs (active MUTE function):

- A muted output, and not selected for adjustment, will have its SELECT/MUTE button permanently lit (not flashing)
- An output that is muted and at the same time selected for setting will have its SELECT/MUTE key flashing at a fixed rate, but inverse to the rate that has an unsilenced output selected for setting

Pressing the CTRL key briefly switches the focus to the other available function, in this case the SRC function, or sound source selection:



The encoder then rotates to select one of the available sound sources, confirming its selection by pressing the encoder:



A long press on the CTRL key allows you to go to the zone equalization screen:



Here, the selected tone control is indicated by the flashing box over the text BASS, MID or TREBLE, and is adjusted by turning the encoder:



Short presses of the CTRL key allow another EQ control to be focused:



A new long press of the CTRL key, or a 10-second timeout, returns the display to its previous state, showing the main data of the zone under control:



All the controls described above for a given zone (VOL, SRC, BASS, MID and TREBLE) will be displayed and available for adjustment only if the **admin** user has enabled the front panel to do so, and a zone may be completely or partially locked out for control from the front panel.

When a particular function of a zone is disabled for adjustment from the front panel, attempting to do so will result in the following message being displayed on the LCD:



When the front panel is completely locked (disabled) for use, pressing any key will result in the following message on the LCD display:

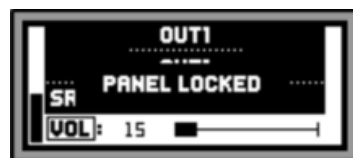

7. FUNCTION LIST

1. Headphone volume control
2. Headphones output: 6.3Mm stereo jack
3. Vumeters LED (CH1 – CH16)
4. Key SELECT / MUTE (CH1 – CH16)
5. Control key, CTRL
6. Digital turning control (encoder)
7. Data traffic indicator LED, DATA
8. Start-up indicator LED, ON
9. LCD screen
10. Start-up switch
11. Fuse holder
12. Network socket base
13. External mute terminal, MUTE
14. Remote control/audio ports (connection with eMCONTROL1)
15. PHANTOM switch
16. PAGER port for connection to eMPAGE1 (IN7 - IN8)
17. Input Gain Adjustment, GAIN (IN7 - IN8)
18. Input terminal (Euroblock) micro and line, MIC/LINE (IN7 - IN8)
19. RJ-45 connector, ETHERNET
20. RS-232 connector RS-232 Connector
21. Input Gain Adjustment, GAIN (IN5 - IN6)
22. Input terminal (Euroblock) micro and line, MIC/LINE (IN5 - IN6)
23. Input Gain Adjustment, GAIN (IN3 - IN4)
24. Input terminal (RCA) line, LINE (IN5 - IN6)
25. Input Gain Adjustment, GAIN (IN1 - IN2)
26. Input terminal (RCA) line, LINE (IN1 - IN2)
27. Input terminal (Euroblock) line, LINE (IN1 - IN2)
28. Output terminals (Euroblock), OUTPUTS

8. FUNCTION DIAGRAM

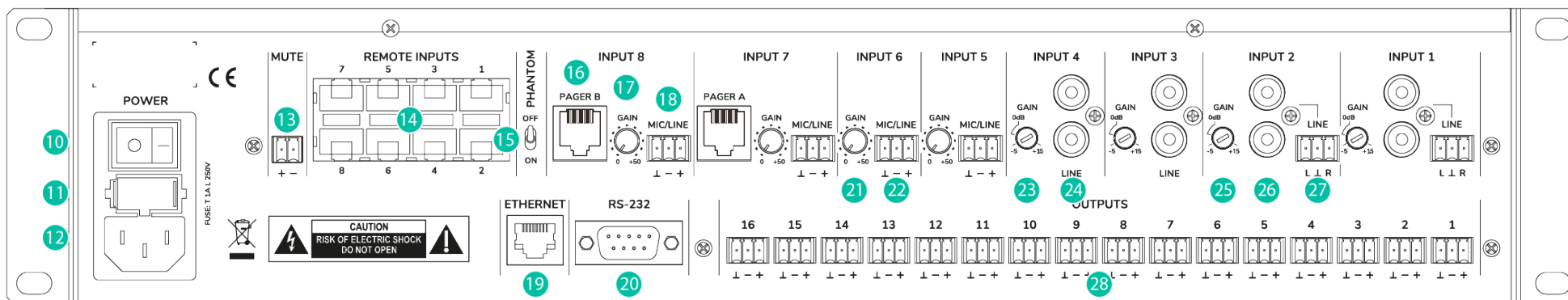
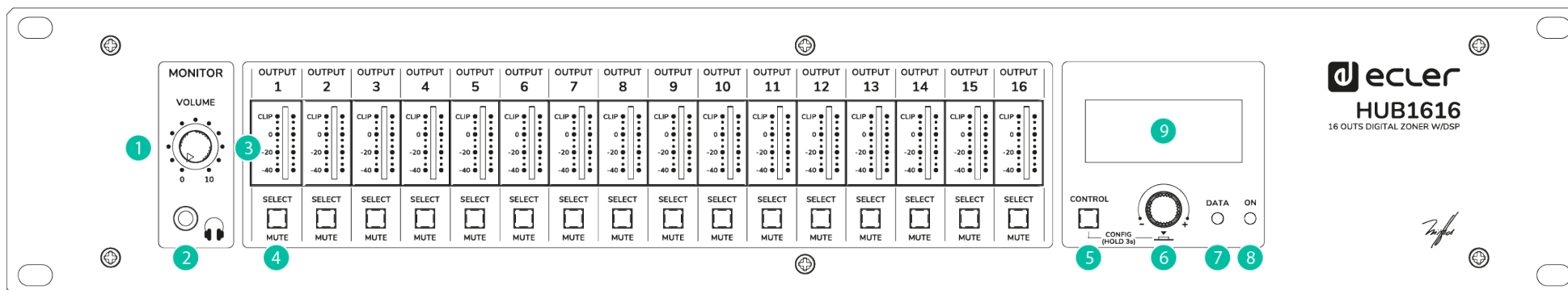

9. BLOCKS DIAGRAM

9.1. HUB1408

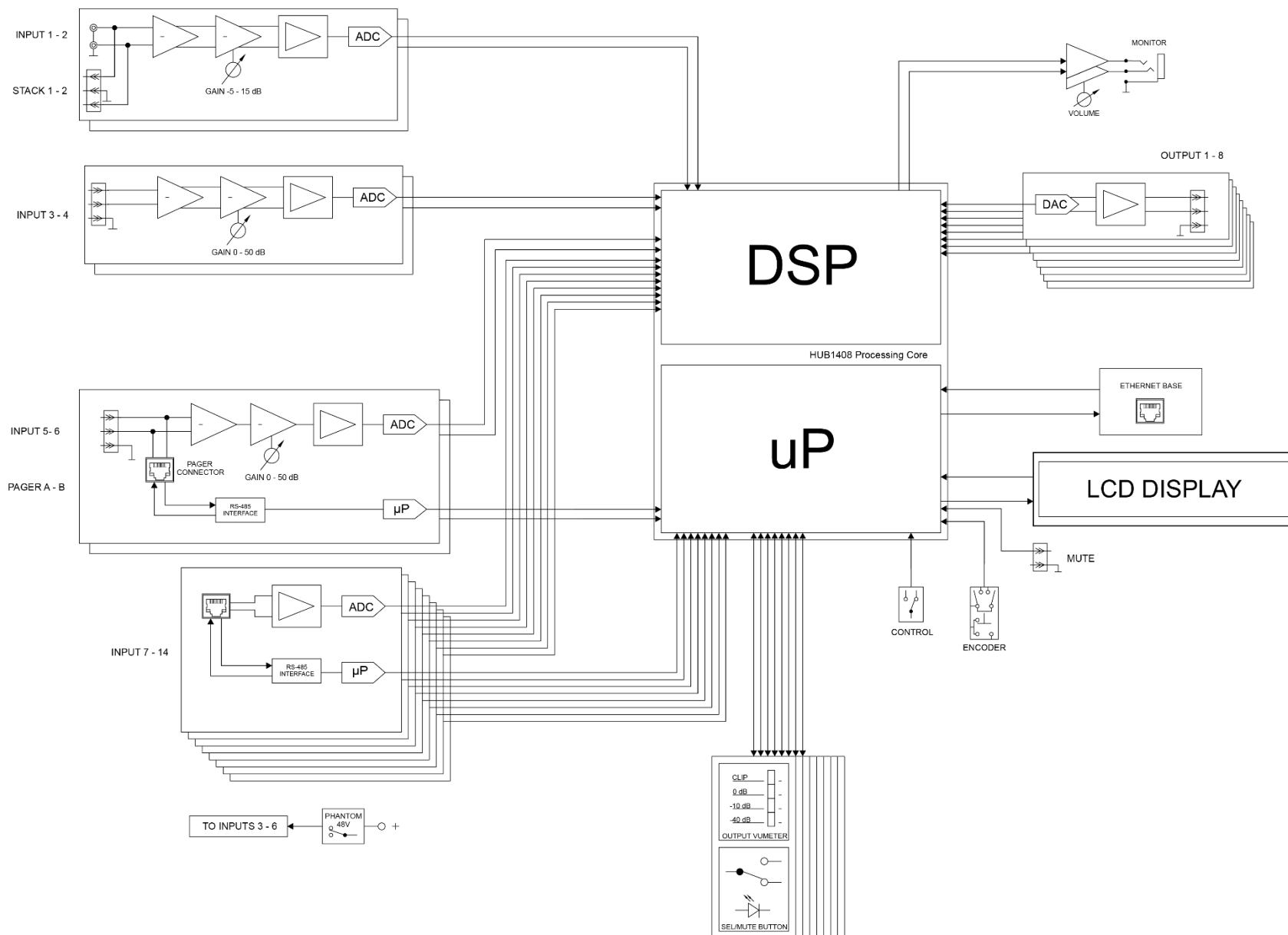

9.2. HUB1616

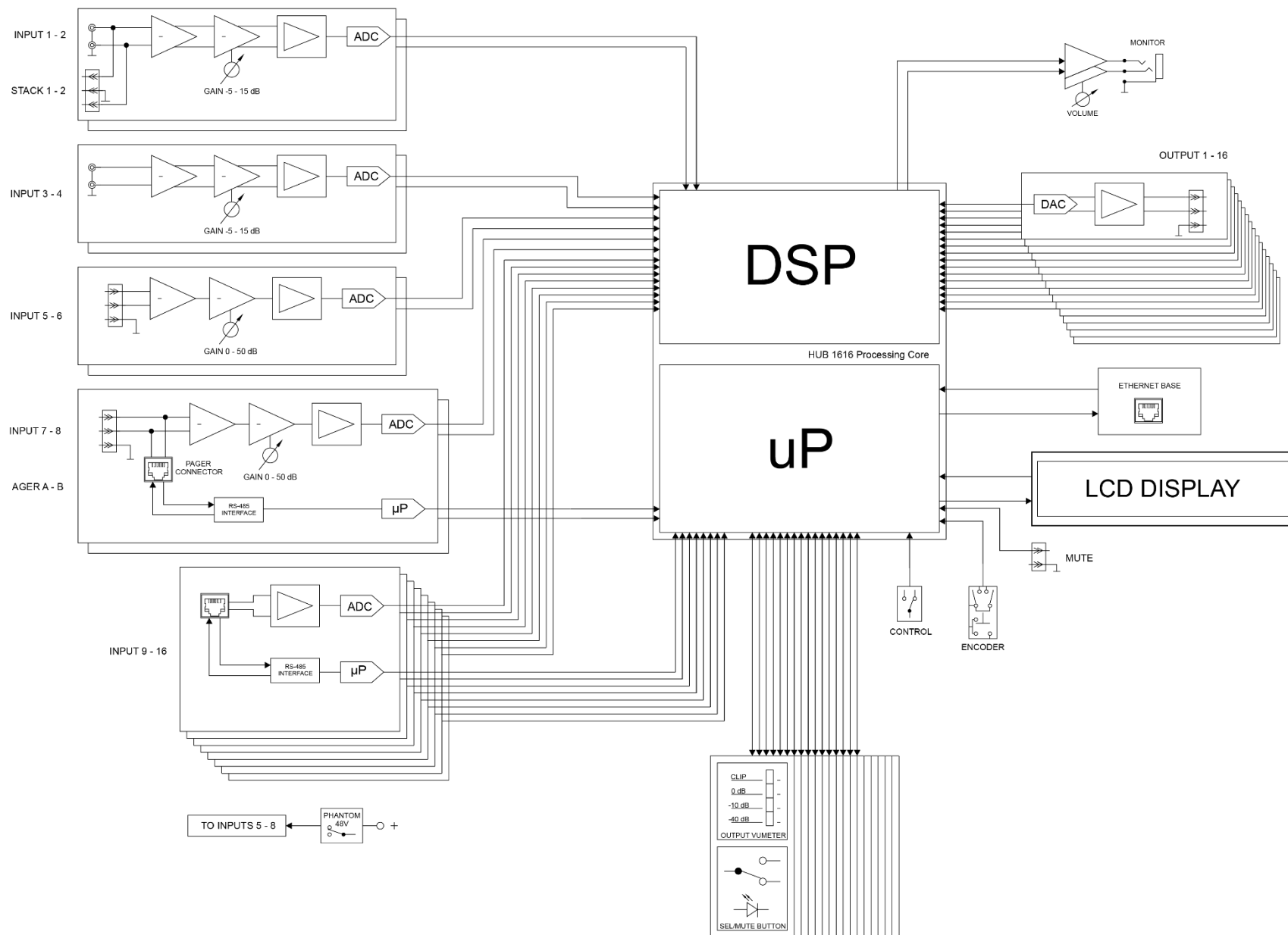

10. TECHNICAL FEATURES

10.1 HUB1408

DIGITAL	
DSP	
CPU	Floating point 32/64bit
Sampling rate	48 kHz
Latency	<1.5 ms.
Converters	
Resolution	24 bit, AKM
Dynamic range	AD:111dB, DA: 115dB
ANALOGUE	
Input 1, 2 (Line)	
Sensitivity	+5 / -15dBV External potentiometer adjustment
Impedance	>13k
Input headroom	12dBV
Connector	RCA female with Euroblock stack
Type	Unbalanced
Input 3, 4, 5 ,6 (Mic/Line)	
Sensitivity	+0 / -50dBV External potentiometer adjustment
Impedance	>24k electronically balanced
Input headroom	12dBV
Connector	Euroblock (Symmetrical)
Type	Balanced
Pagers	Input 5 and 6 (by RJ45 connector)
Phantom	+48VDC (rear panel switch)
CMRR	>60dB (20Hz - 20kHz)
Input 7 to 14 (Remote Input)	
Sensitivity	0dBV without adjustment
Impedance	>24k electronically balanced
Input headroom	12dBV
Connector	RJ45 Connector
Type	Balanced
CMRR	>60dB (20Hz - 20kHz)
Outputs 1 to 8 (Line)	
Max output level	12dBV
Connector	Euroblock 3-pin
Type	Balanced
Headphones output	
Selectable output	From Out1 to Out8

Power	>200mW – 200Ω
Connector	Mini-Jack 3,5mm
General	
External mute	Normally open. Assignable to any output zone
Frequency response	<10Hz ~ 20kHz (+0dB / -0.5dB)
Output noise floor (FFT)	>110dB (from 20Hz to 20kHz)
THD + Noise	< 0.005% (1kHz, 1Vrms)
Crosstalk	>90dB, 20Hz - 20kHz
CMRR	>60 dB Typical
Flatness	Better than ±0.1dB
PROCESSING	
Input level (x14)	
Volume	From Off to 0 dB
Mute	On-Off
Metering	Vumeter post fader
Stereo	On-Off (Inputs 3 to 6)
Polarity	On-Off
High pass filter	50Hz to 150Hz (Inputs 3 to 6)
Frequency shifter	On-Off; 5Hz (Inputs 3 to 6)
Noise gate (x4)	
Inputs	Input 3 to 6, Bypass ON - OFF
Threshold	From -80dBV to +12dBV
Depth	From 0 dB to 80 dB
Attack	From 0.1ms to 500ms
Hold	From 10ms to 3000ms
Release	From 10ms to 1000ms
Input EQ (x14)	
Type	Baxandall 3-way EQ
Gain	-10dB ~ +10dB in 0.1dB steps
Frequency	Low 200Hz Mid 1kHz High 6.3kHz
Output level (x8)	
Volume	From Off to 0 dB
Mute	On-Off
Metering	Vumeter post fader
Stereo	On-Off
Polarity	On-Off
Output EQ (x8)	
Type	Baxandall 3-way EQ
Gain	-10dB ~ +10dB in 0.1dB steps
Frequency	Low 200Hz Mid 1kHz High 6.3kHz

Output graphic EQ (x8)	
Type	8-Band Graphic EQ
Gain	-10dB ~ +10dB in 0.1dB steps
Frequency	63Hz, 125Hz, 250Hz, 500Hz, 1kHz, 2kHz, 4kHz, 8kHz
Output compressor (x8)	
Bypass	On-Off
Mode	Compressor / Limiter
Threshold	-36 dB to +12 dB
Ratio	1 to 100
Knee	Soft / Hard
Attack	0.1ms to 500ms
Release	10ms to 1000ms
Make-up gain	0 dB to 10 dB
Output delay (x8)	
Outputs	1 to 8
Bypass	On-Off
Delay	0 to 300ms
Unit	ms, meters, feet
Output crossover (x8)	
Outputs	1 to 8
Bypass	On-Off
Mode	High Pass Filter / Low Pass Filter
Frequency	20Hz to 20kHz
General volume	
Volume	From Off to 0dB
Selectable outputs	Out 1 – Out 8
Ducker	
Input	IN3 to IN6. In 5 and 6 selectable: DUCKER or PAGER
Outputs	Selectable: 1-8 zones
Priority	Four levels (1max-4min)
Priority volume	-40 dB to +6 dB
Threshold	-80dB to +12dB
Depth	0dB to 80 dB
Attack	5ms to 2000ms
Release	50ms to 3000ms
Hold	10ms to 3000ms

Pager	
Input	IN5 and IN6 selectable: DUCKER or PAGER
Outputs	Selectable: 1-16 zones
Functions	Two function buttons (F1, F2)
Priority	Four levels (1max-4min)
Priority volume	-40 dB to +6 dB
Chime volume	-12dB to +0dB
Chime melody	None, Melody 1, Melody 2
Depth	0dB to 80 dB
Attack	5ms to 2000ms
Release	50ms to 3000ms
Pilot panels	
General	On-Off, Public, Label, Users and Zone
Volume control	On-Off, Label and Style
Source selection	On-Off, Label and Allowed sources
Equalizer	On-Off, Label, and Style
Color	Controls, Text and Background
OTHERS	
Mechanical	
Dimensions (WxHxD)	482.6 x 88.0 x 200.0 mm / 19.0 x 3.5 x 7.9 in.
Weight	3,60kg / 7.93 lb.
Power supply	
Mains	90-240 VAC, 50-60Hz
Power consumption	20W
Connectivity	
Management Connectivity	Ethernet Base-Tx 10/100Mb Auto X-Over CAT5 up to 100m
Remote bus	RS485
Aux. Power Supply for Remotes	+12VDC, 0,6A max. (short circuit protected)
Programming and control	Hangar (embedded web application), Ecler pilot (Android/iOS application), TPNET (UDP/RS-232)

10.2 HUB1616

DIGITAL	
DSP	
CPU	Floating point 32/64bit
Sampling rate	48 kHz
Latency	<1.5 ms.
Converters	
Resolution	24 bit, AKM
Dynamic range	AD:111dB, DA: 115dB
ANALOGUE	
Input 1, 2, 3, 4 (Line)	
Sensitivity	+5 / -15dBV External potentiometer adjust
Impedance	>13k
Input headroom	12dBV
Connector	RCA female. Input 1 and 2 with Euroblock stack
Type	Unbalanced
Input 5, 6, 7, 8 (Mic/Line)	
Sensitivity	+0 / -50dBV External potentiometer adjustment
Impedance	>24k electronically balanced
Input headroom	12dBV
Connector	Euroblock (Symmetrical)
Type	Balanced
Pagers	Input 7 and 8 (by RJ45 connector)
Phantom	+48VDC (rear panel switch)
CMRR	>60dB (20Hz - 20kHz)
Input 9 to 16 (Remote Input)	
Sensitivity	0 dBV without adjustment
Impedance	>24k electronically balanced
Input headroom	12dBV
Connector	RJ45 Connector
Type	Balanced
CMRR	>60dB (20Hz - 20kHz)
Outputs 1 to 16 (Line)	
Max output level	12dBV
Connector	Euroblock 3-pin
Type	Balanced
Headphones output	
Selectable output	From Out1 to Out16
Power	>200mW – 200Ω
Connector	Mini-Jack 3,5mm

General	
External mute	Normally open. Assignable to any output zone
Frequency response	<10Hz ~ 20kHz (+0dB / -0.5dB)
Output noise floor (FFT)	>110dB (from 20Hz to 20kHz)
THD + Noise	< 0.005% (1kHz, 1Vrms)
Crosstalk	>90dB, 20Hz - 20kHz
CMRR	>60 dB Typical
Flatness	Better than ± 0.1 dB
PROCESSING	
Input level (x16)	
Volume	From Off to 0 dB
Mute	On-Off
Metering	Vumeter post fader
Stereo	On-Off (Inputs 5 to 8)
Polarity	On-Off
High pass filter	50Hz to 150Hz (Inputs 5 to 8)
Frequency shifter	On-Off; 5Hz (Inputs 5 to 8)
Noise gate (x4)	
Inputs	Input 5 to 8, Bypass ON - OFF
Threshold	From -80dBV to +12dBV
Depth	From 0 dB to 80 dB
Attack	From 0.1ms to 500ms
Hold	From 10ms to 3000ms
Release	From 10ms to 1000ms
Input EQ (x16)	
Type	Baxandall 3-way EQ
Gain	-10dB ~ +10dB in 0.1dB steps
Frequency	Low 200Hz Mid 1kHz High 6.3kHz
Output level (x16)	
Volume	From Off to 0 dB
Mute	On-Off
Metering	Vumeter post fader
Stereo	On-Off
Polarity	On-Off
Output EQ (x16)	
Type	Baxandall 3-way EQ
Gain	-10dB ~ +10dB in 0.1dB steps
Frequency	Low 200Hz Mid 1kHz High 6.3kHz
Output graphic EQ (x16)	
Type	8-Band Graphic EQ
Gain	-10dB ~ +10dB in 0.1dB steps
Frequency	63Hz, 125Hz, 250Hz, 500Hz, 1kHz, 2kHz, 4kHz, 8kHz

Output compressor (x16)	
Bypass	On-Off
Mode	Compressor / Limiter
Threshold	-36 dB to +12 dB
Ratio	1 to 100
Knee	Soft / Hard
Attack	0.1ms to 500ms
Release	10ms to 1000ms
Make-up gain	0 dB to 10 dB
Output delay (x8)	
Outputs	1 to 8
Bypass	On-Off
Delay	0 to 300ms
Unit	ms, meters, feet
Output crossover (x8)	
Outputs	1 to 8
Bypass	On-Off
Mode	High Pass Filter / Low Pass Filter
Frequency	20Hz to 20kHz
General volume	
Volume	From Off to 0dB
Selectable outputs	Out 1 – Out 16
Ducker	
Input	IN5 to IN8. In 7 and 8 selectable: DUCKER or PAGER
Outputs	Selectable: 1-16 zones
Priority	Four levels (1max-4min)
Priority volume	-40 dB to +6 dB
Threshold	-80dB to +12dB
Depth	0dB to 80 dB
Attack	5ms to 2000ms
Release	50ms to 3000ms
Hold	10ms to 3000ms
Pager	
Input	IN7 and IN8 selectable: DUCKER or PAGER
Outputs	Selectable: 1-16 zones
Functions	Two function buttons (F1, F2)
Priority	Four levels (1max-4min)
Priority volume	-40 dB to +6 dB
Chime volume	-12dB to +0dB
Chime melody	None, Melody 1, Melody 2
Depth	0dB to 80 dB
Attack	5ms to 2000ms
Release	50ms to 3000ms

Pilot panels	
General	On-Off, Public, Label, Users and Zone
Volume control	On-Off, Label and Style
Source selection	On-Off, Label and Allowed sources
Equalizer	On-Off, Label, and Style
Colour	Controls, Text and Background
OTHERS	
Mechanical	
Dimensions (WxHxD)	482.6 x 88.0 x 200.0 mm / 19.0 x 3.5 x 7.9 in.
Weight	3,66kg / 8.07 lb.
Power supply	
Mains	90-240 VAC, 50-60Hz
Power consumption	20W
Connectivity	
Management Connectivity	Ethernet Base-Tx 10/100Mb Auto X-Over CAT5 up to 100m
Remote bus	RS485
Aux. Power Supply for Remotes	+12VDC, 0,6A max. (short circuit protected)
Programming and control	Hangar (embedded web application), Ecler pilot (Android/iOS application), TPNET (UDP/RS-232)

HANGAR & PILOT

SOFTWARE

Software and control App for the HUB series



HANGAR

HUB SERIES WEB APP



PILOT

HUB SERIES CONTROL APP

USER MANUAL

11. HANGAR & PILOT INTRODUCTION

The configuration and control of the digital zone managers of the HUB series is done through its embedded web application HANGAR. This user interface can be managed from any web browser, running on any device, be it Windows, MacOS, Tablet or a Smartphone.

We recommend upgrading the browser to its latest version for proper application operation.

Demo version available! Visit our website and access the HANGAR application online, without the need to physically connect to a HUB device, to explore all the possibilities of the devices. Visit the versions available on the corresponding product pages:

- www.ecler.com/hubseriesdemo/

Note: some features are not available, requiring a physical connection to a HUB device, such as a firmware update.

11.1. VERSIONS

- **V1.0r5 (June 2020) – Last firmware version**
- V1.0r0 (April 2020)

11.2. PUBLISHING NOTES

- The "Allow Loading Predefined Setups" option is removed from Users. It could accidentally cause the delete of already created Users.

11.3. LIST OF COMPATIBLE DEVICES

- HUB1616
- HUB1408

12. FIRST STEPS

To access the HANGAR web application from an external device (computer, Tablet, etc.) through a web browser, first make sure that both are physically connected to the same local network (LAN) and configured within the same network range.

The HUB devices have DHCP (Dynamic IP address assignment), in addition to being able to manually configure the network parameters. There are 2 procedures to connect to the HANGAR web application embedded in the HUB devices.

12.1. AUTOMATIC CONNECTION

By default, the network configuration is in DHCP mode so if you have a router/switch with a DHCP server (see your device specifications), you don't have to configure the network parameters, it will be done automatically. Follow these steps:

1. Connect the HUB device to the router/switch using a CAT5 cable or higher (Ethernet port on the HUB device)
2. Connect the device with a web browser (computer, tablet, etc.) to the same local network (router/switch). You can do it by cable or by Wi-Fi, depending on your network device and computer/Tablet.
3. Check the IP assigned to the device to access the web application from your browser. To consult the network parameters, press and hold the CTRL and rotary encoder keys simultaneously for 3 seconds.

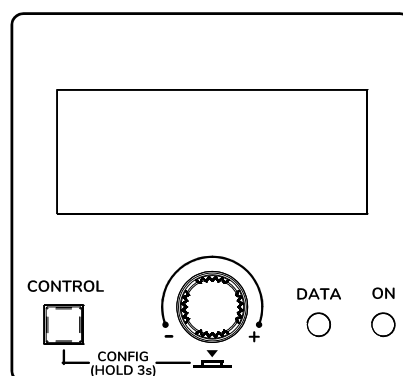

Figure 16: Front panel LCD display and control keys

Note: HUB devices use the mDNS service so that they can be accessed in an intuitive way, through a web browser in the same local network (LAN) when the computer is **connected by cable** (not available when connected via WiFi). To do this, enter in the search bar of your browser: `device_name.local`. By default, “hub1616.local” in HUB1616, “hub1408.local” in HUB1408.

The configuration screen (CONFIG) shows the following information:

- Firmware version running on the unit.
 - NAME: name of the HUB unit
 - Network connection parameters: IP address, subnet mask and network gateway
 - Auto/Manual: IP assignment mode. AUTO: is in DHCP mode, the IP address assignment is automatic. MANUAL: allows the configuration of manual network parameters. Default:
 - IP: 192.168.0.100
 - MASK: 255.255.0.0
 - GW: 192.168.0.1
 - Admin: number of admin users connected to the unit (0 or 1)
 - Users: number of client users, via Ecler pilot application or web browsers (0 to 20)
4. Finally open your browser and enter the IP address shown in the configuration screen, or “hub1616.local” (using the mDNS service in a HUB1616, for example).

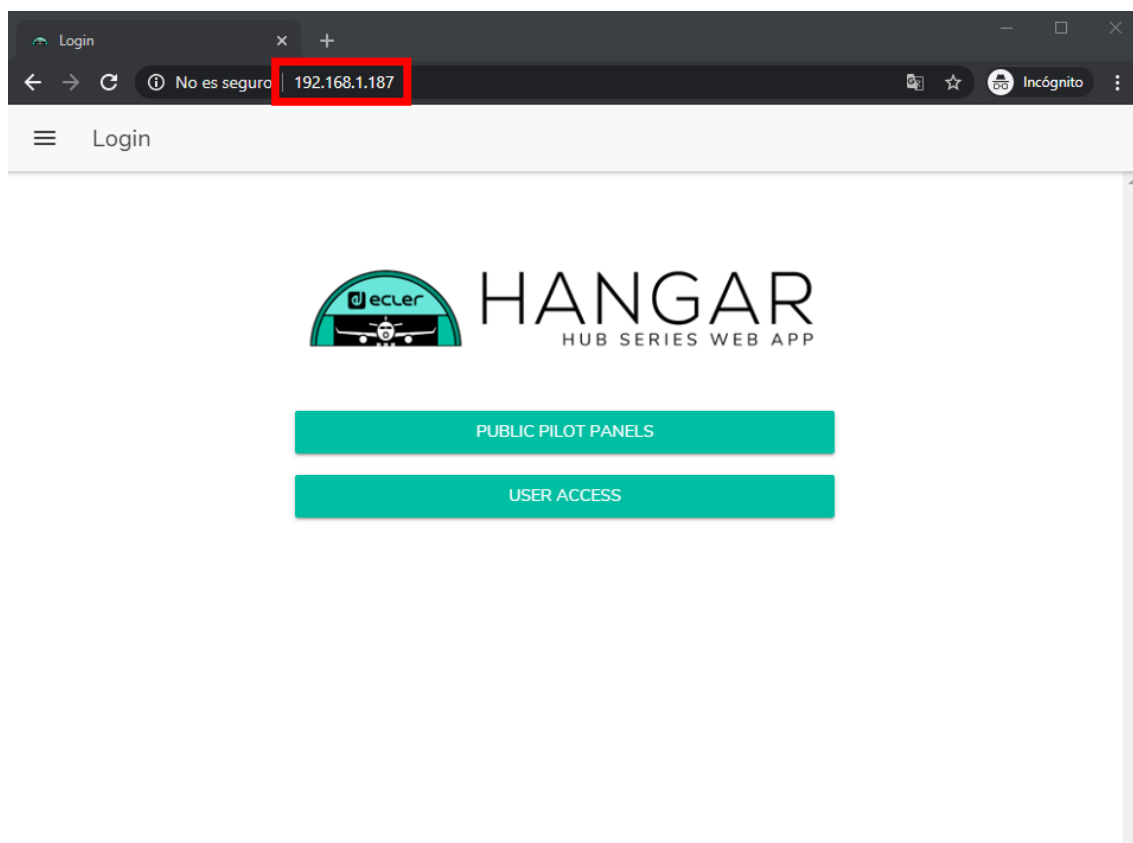

Figure 17: login page for the HANGAR web application

12.2 MANUAL CONNECTION

If you wish to connect through a network with static IP addressing, you will need to make a manual configuration. Follow these steps:

1. Access the configuration (CONFIG) page on the front panel by pressing and holding the CTRL and rotary encoder keys simultaneously for 3 seconds.
2. Change the IP assignment mode of the HUB device to manual ("MAN.") by turning the rotary encoder and confirming. The device will restart with the default network parameters
 - IP: 192.168.0.100
 - MASK: 255.255.0.0
 - GW: 192.168.0.1
3. If the default network configuration of the HUB device is not in the same IP range as that of your external device (computer, etc.), you must change the latter's so that both are in the same range and the connection can be established.
4. Connect the HUB device point to point, using a CAT5 cable or higher, to a computer.
5. Access the HANGAR web application by entering the IP address shown in the configuration screen, or "hub1616.local" (using the mDNS service in a HUB1616, for example).
6. Change the network configuration of the HUB device according to the IP range established in your local network. See chapter [ACCESS TO THE WEB APPLICATION HANGAR](#)
7. Disconnect the HUB device from the computer and connect it to the local network.
8. Connect the computer to this network.
9. Make the necessary network settings on the computer so that it is within the IP range supported by your local network.
10. Open the HANGAR web application again, entering the new IP previously assigned to the HUB device.

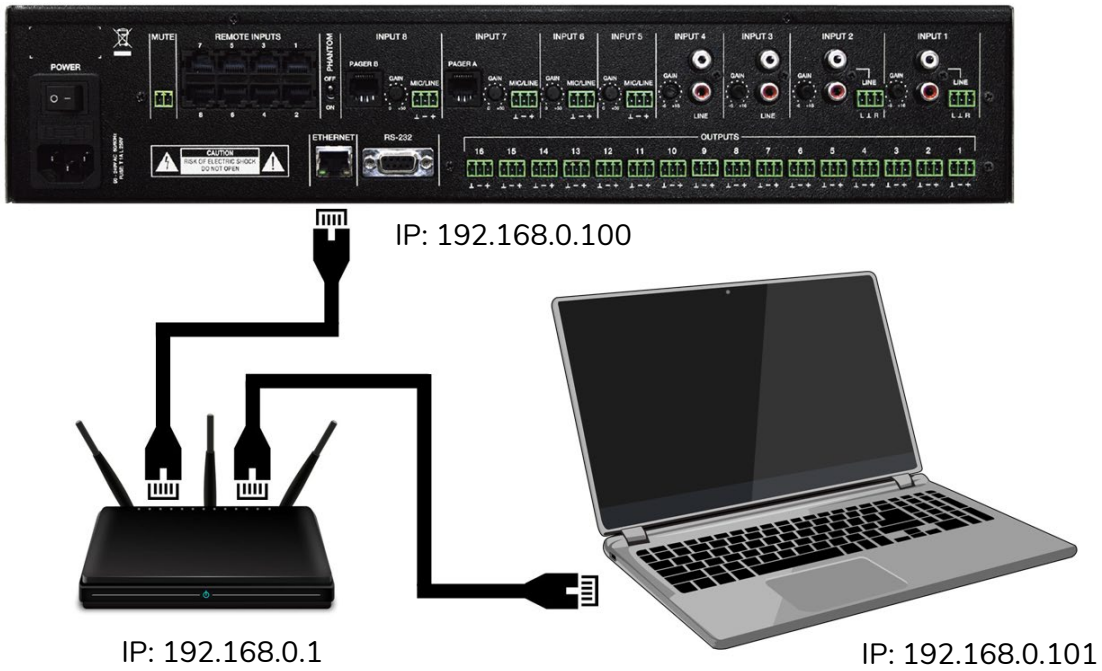

Figure 18: LAN local network connection

13. ACCESS TO THE WEB APPLICATION HANGAR

Once the 2 devices, HUB and computer/Tablet/Smartphone, etc. are connected in the same local network, and configured within the same IP range, open your preferred browser on the control device (computer e.g.) and enter the IP address of the HUB device in the browser bar. You will access the HANGAR web application.

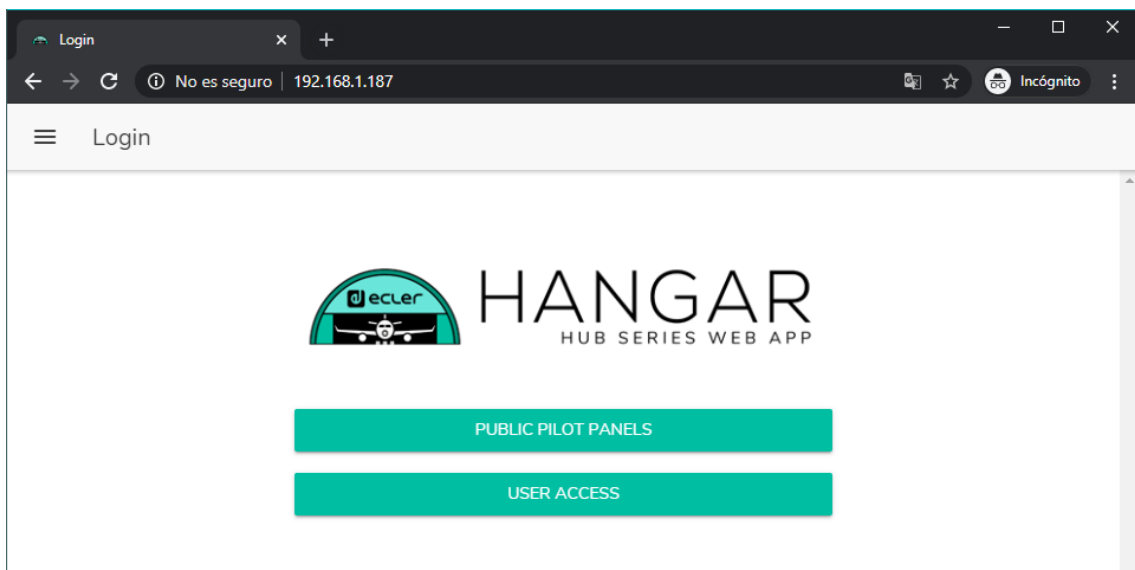

Figure 19: login page for the HANGAR

There are 2 types of access to the application:

- **Public pilot panels:** access to pilot zone control panels, public profile (no access credentials required). These control panels are created by the administrator. See chapter [PILOT PANELS](#) for more details about the control panels.
- **User**, with 2 access levels:
 - **Administrator:** as an administrator, you have access to all the functions of the HUB device, you can configure any parameter of the matrix and its peripherals, and you are the one who creates the different users and control panels for the **Ecler pilot** application.
 - **Users:** users (non-administrators, or end users of the system) have limited access. The functions they can perform are only for control (control the volume of a certain output, e.g.), never for configuration.

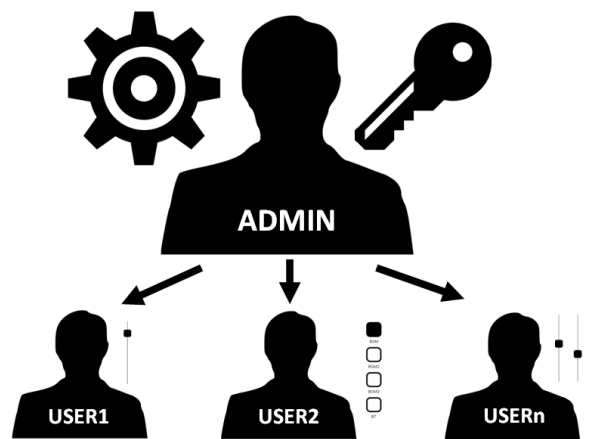

Figure 20: administrator-users hierarchy

Both the access as administrator and the access of the different users are protected by a password. By default, to access as administrator, these are the credentials:

- Username: admin
- Password: admin

The administrator can change his own access password from the HANGAR web application, as well as manage the users and passwords for them.

Note: Both the username and the password **are case sensitive**.

In the chapters from [CONFIGURATION](#) to [PILOT PANELS](#) included, the web application is displayed and explained once you are logged in as administrator. In chapter [ACCESS TO PUBLIC PILOT PANELS](#) and in chapter [ACCESS TO THE WEB APP AS A USER](#), the web application is explained in detail when you access it as a user.

14. CONFIGURATION

Once the application is accessed as an **administrator**, the first page displayed is the configuration page.

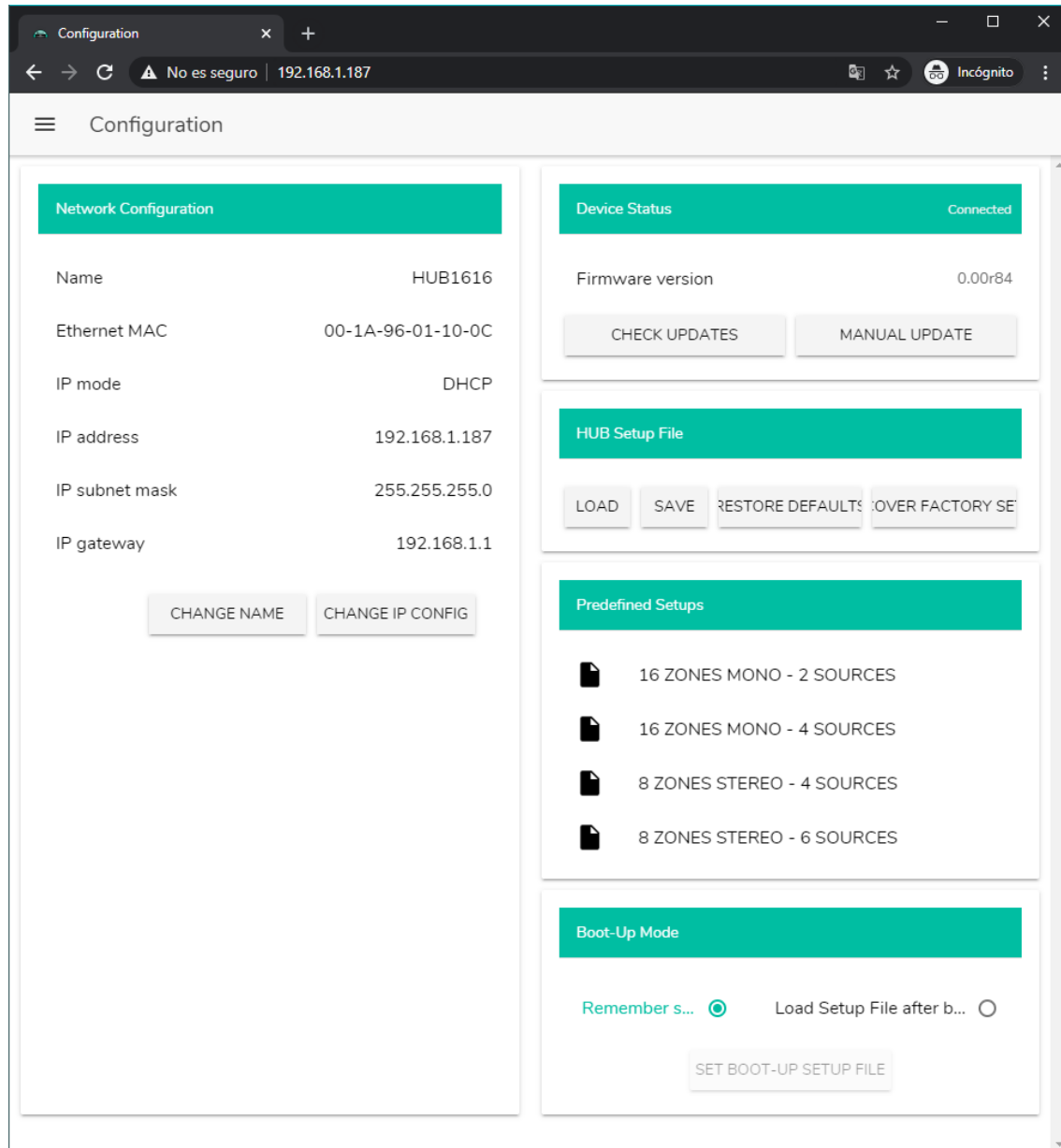

Figure 21: configuration page (CONFIGURATION)

On the upper left corner of the options menu, you can display the user's connection status of the HUB device:

- **Connected as:** displays the connected user, either the administrator or a user, in which case the name given to the user will be displayed:

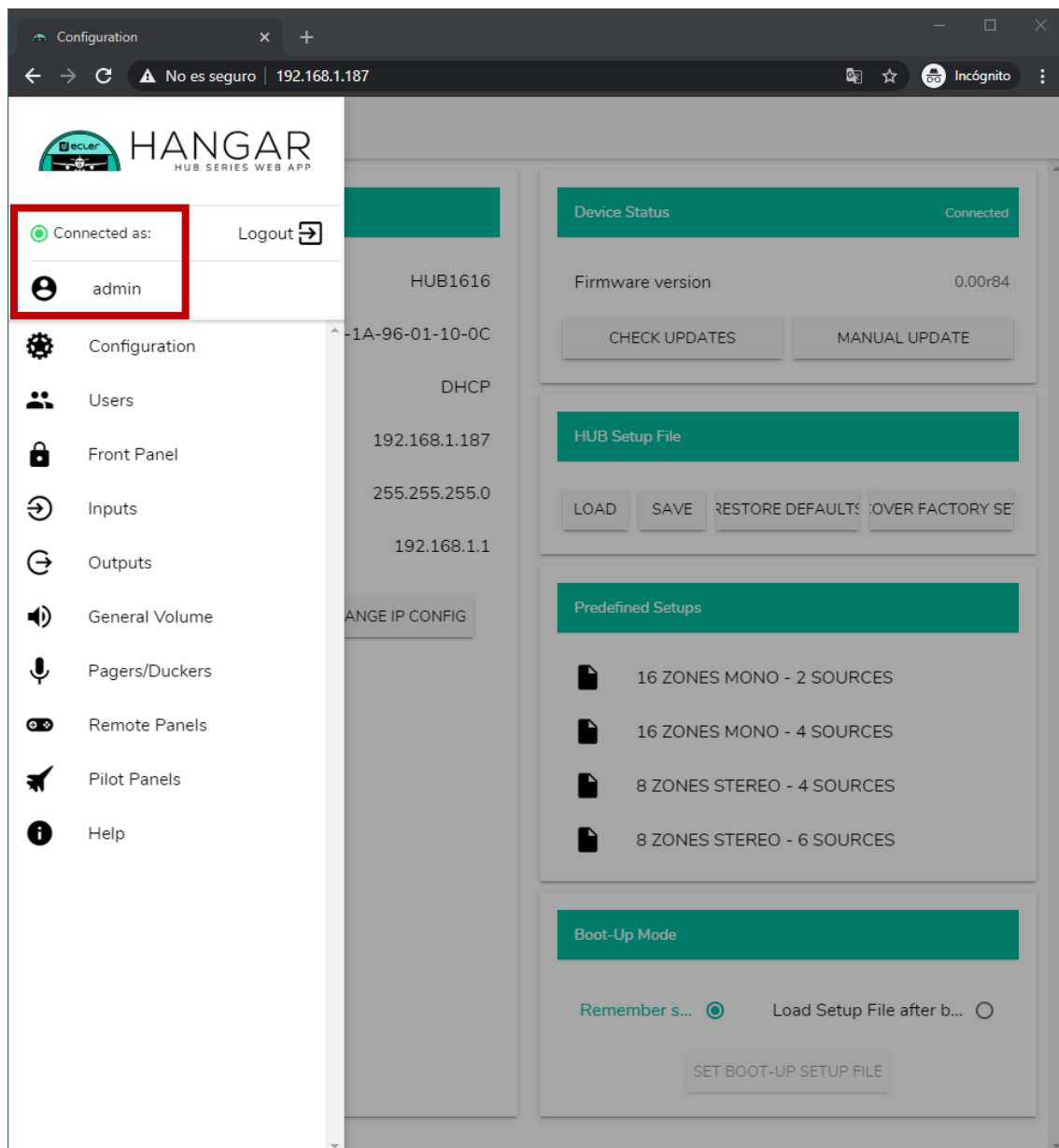
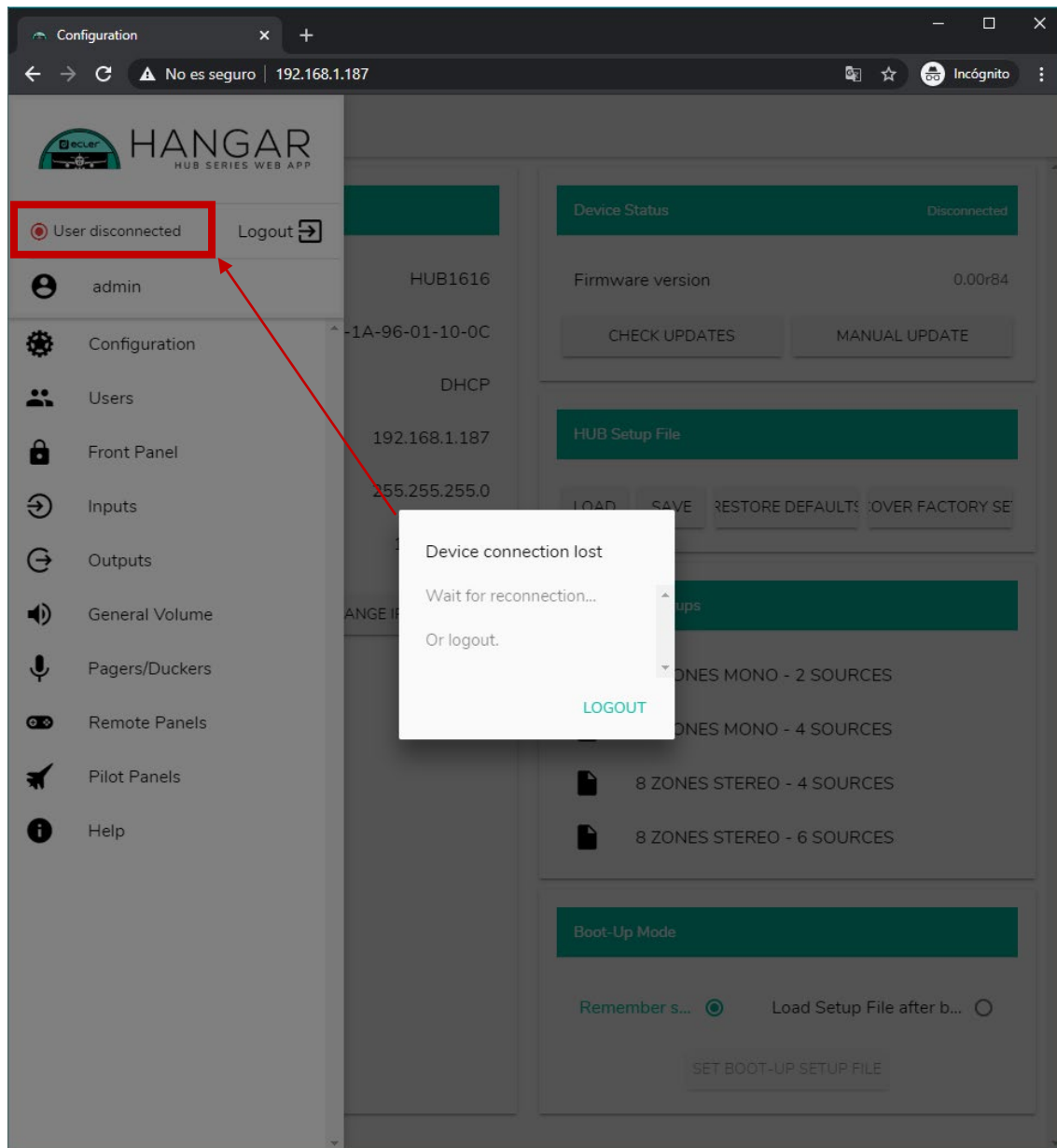

Figure 22: connected user

- **User disconnected:** This is displayed when a connection to the HUB device cannot be established. Check the network status.



Next to the connection status, you can find the logout button.

The same browser session can only keep one user session open in the HANGAR web application. So if you need to change users on the same device, you must first log out and log in again with another user.

14.1 NETWORK CONFIGURATION

In this box, you can configure the Ethernet network parameters of the HUB device, in addition to its name.

- **Name:** name of the device.
- **Ethernet MAC:** read-only parameter, unique and assigned by the manufacturer of any Ethernet device.
- **IP mode:** indicates the IP addressing mode: DHCP or STATIC.
- **IP address:** IP address.
- **IP subnet mask:** subnet mask.
- **IP gateway:** gateway.

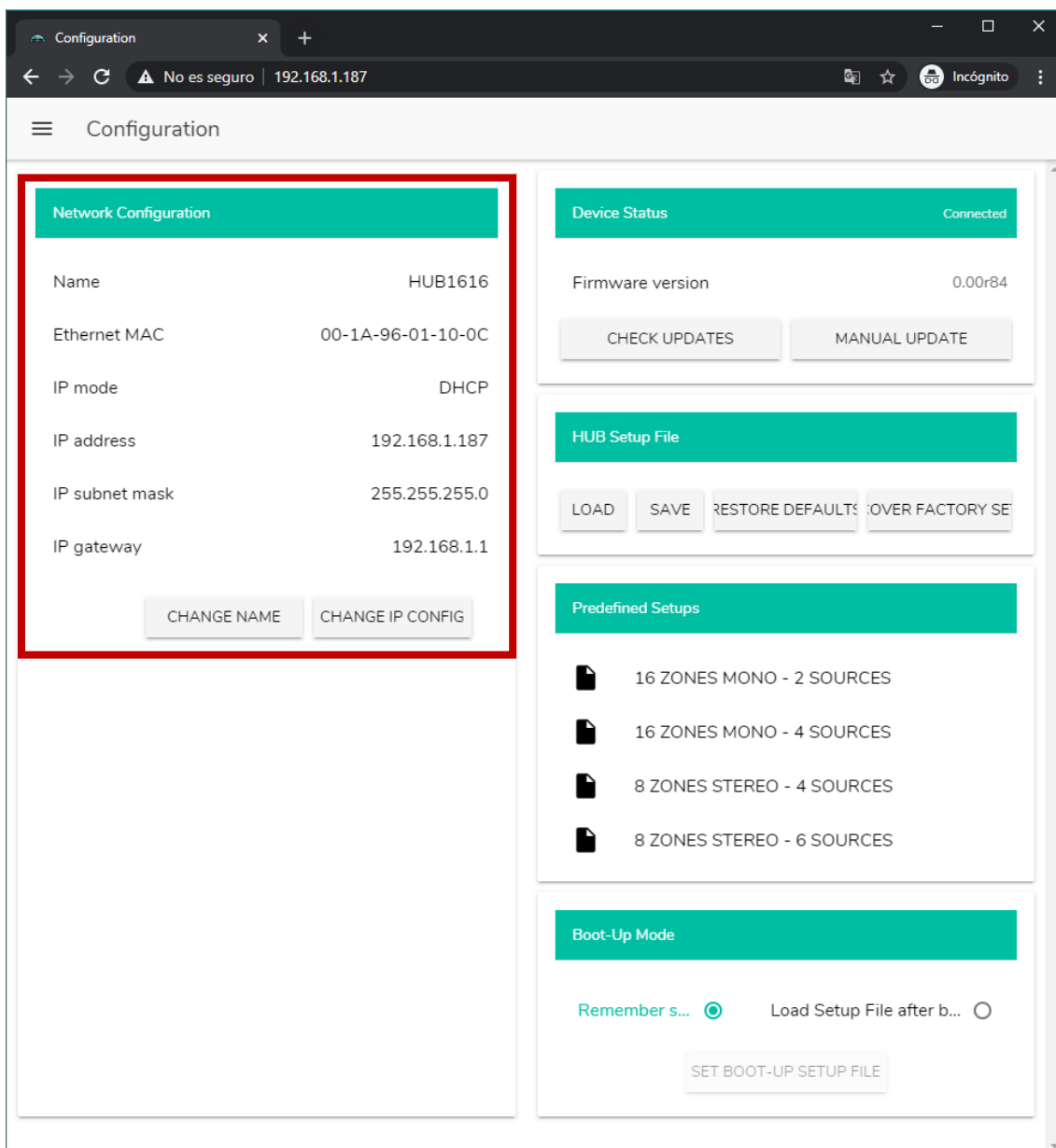

The screenshot shows a web-based configuration interface for a HUB device. The browser address bar shows the URL 192.168.1.187. The main content area is titled 'Configuration' and is divided into several sections:

- Network Configuration:** This section is highlighted with a red border and contains the following parameters:

Name	HUB1616
Ethernet MAC	00-1A-96-01-10-0C
IP mode	DHCP
IP address	192.168.1.187
IP subnet mask	255.255.255.0
IP gateway	192.168.1.1

 Below the table are two buttons: 'CHANGE NAME' and 'CHANGE IP CONFIG'.
- Device Status:** Shows the device is 'Connected' with a firmware version of '0.00r84'. It includes buttons for 'CHECK UPDATES' and 'MANUAL UPDATE'.
- HUB Setup File:** Includes buttons for 'LOAD', 'SAVE', 'RESTORE DEFAULTS', and 'OVER FACTORY SE'.
- Predefined Setups:** Lists four preset configurations:
 - 16 ZONES MONO - 2 SOURCES
 - 16 ZONES MONO - 4 SOURCES
 - 8 ZONES STEREO - 4 SOURCES
 - 8 ZONES STEREO - 6 SOURCES
- Boot-Up Mode:** Features two radio buttons: 'Remember s...' (selected) and 'Load Setup File after b...'. A 'SET BOOT-UP SETUP FILE' button is located below.

Figure 23: network configuration

To change the network parameters, press the CHANGE IP CONFIG button. A dialog box will open where you can choose the IP addressing mode: DHCP or STATIC. By default, the HUB device is set to DHCP. If static IP addressing is required, select the STATIC option and modify the network parameters according to your local network. Once the changes are applied, pressing the APPLY & REBOOT button will restart the device with the new network configuration.

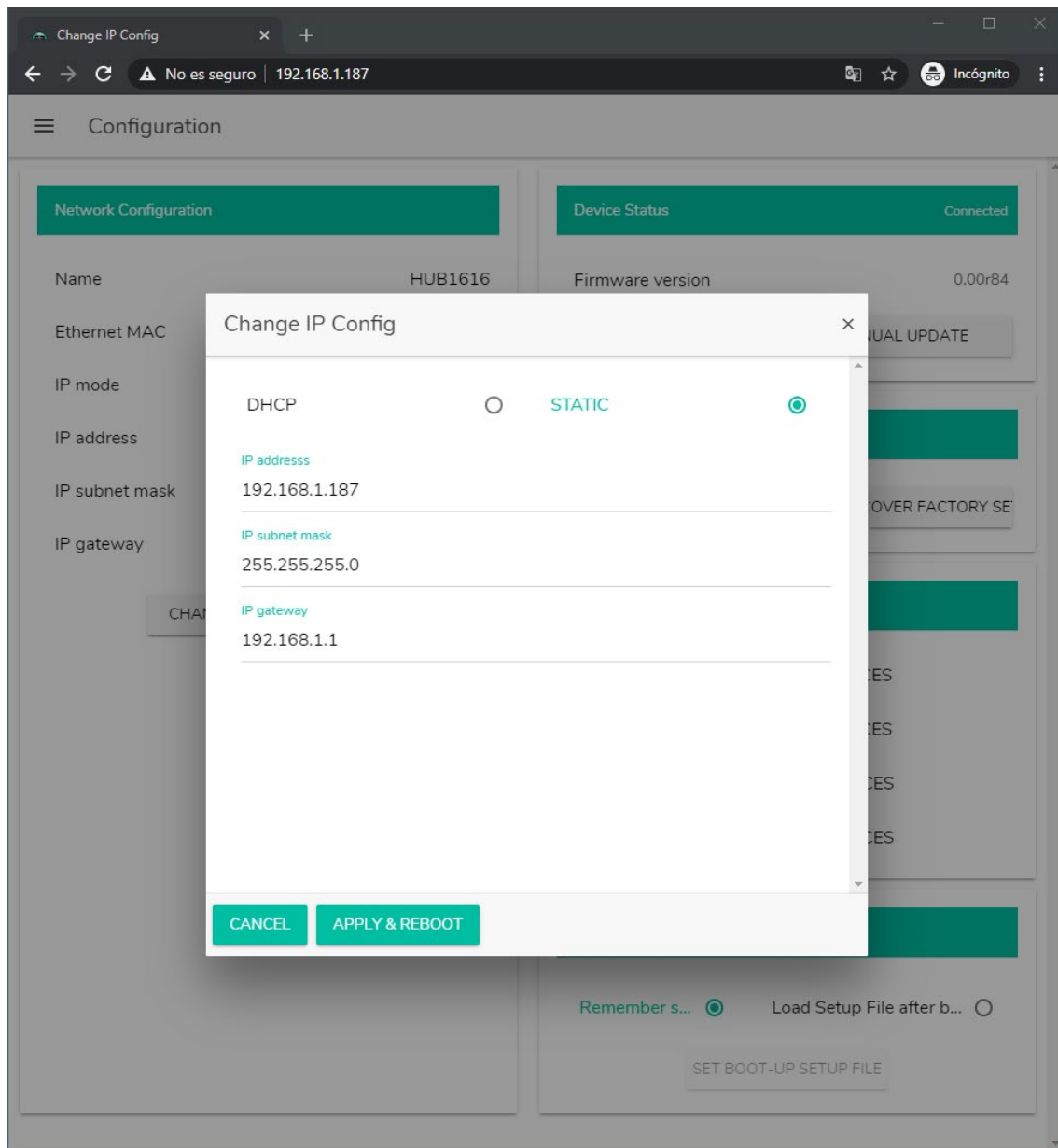

Figure 24: modification of the network configuration

14.2. DEVICE STATUS

This box shows the device connection, *connected* or *disconnected*, and the current firmware version running on the HUB unit:

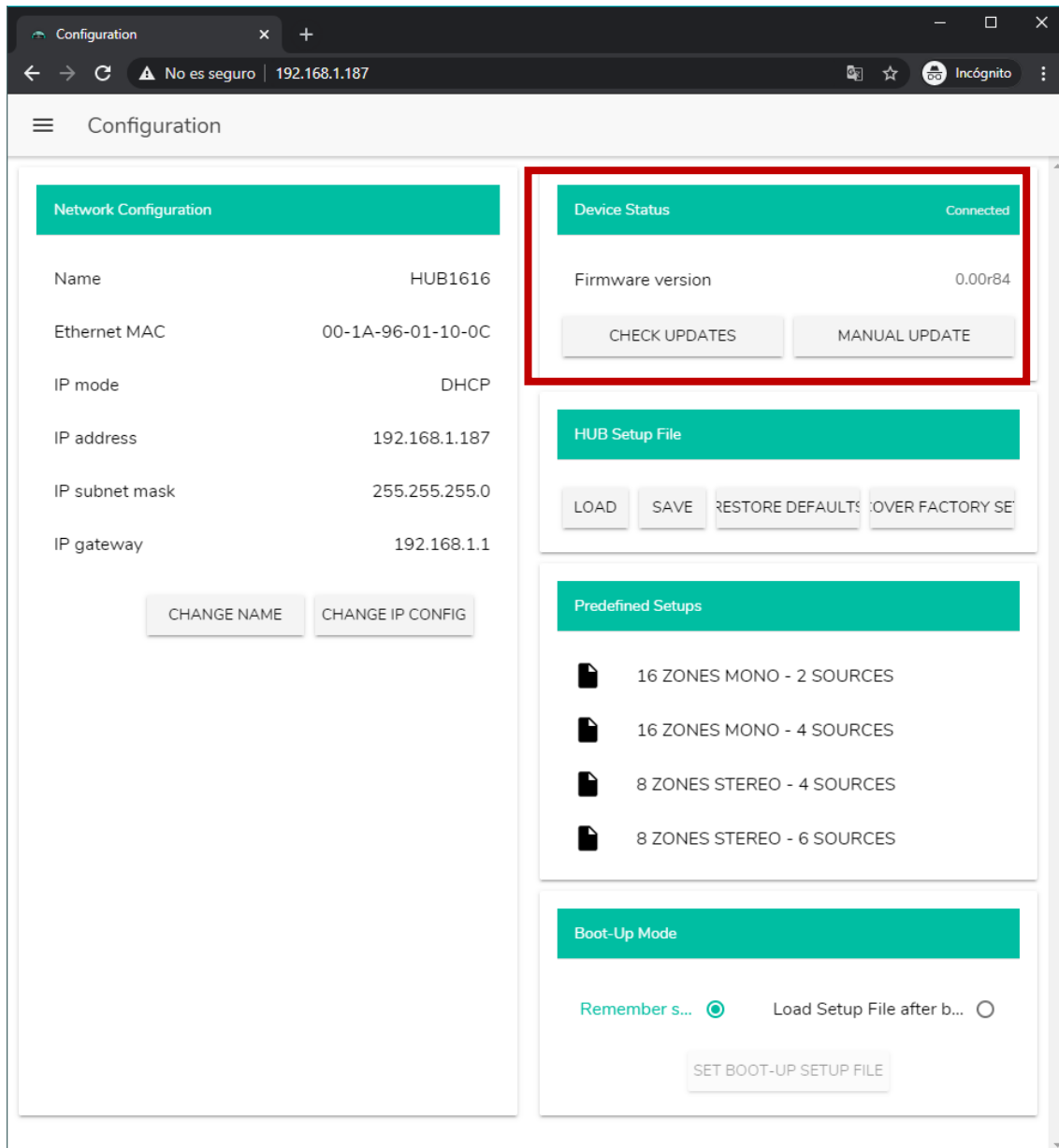

Figure 25: DEVICE STATUS

- **Check updates:** automatically searches for the latest firmware version available. If there is a more recent version, the device will be updated after confirmation. Internet connection is required to use this function.
- **Manual update:** clicking on this box opens a folder browser window, from where you must select a valid, previously downloaded firmware file on your computer (HUB_v1_01r01.bin for example).

This process, if completed successfully, should keep the previous configuration of the HUB unit complete.

IMPORTANT NOTE: The firmware upgrade operation is delicate, and if it is not successfully completed you may lose the configuration of your HUB device. **Be sure to save a copy of the project before updating the device.**

Try to always have the latest available firmware version installed on your HUB unit. The latest official version can be found on the HELP page (see chapter [HELP](#)).

14.3. HUB SETUP FILE

This box manages the HUB configuration files, as well as being able to reset the device to its factory configuration or completely reset it (without configuration, if you want to start from scratch).

Note: the configuration files are unique to each model. Thus the extension of a configuration file for a HUB1616 is “.HUB1616” while a configuration file for a HUB1408 is “.HUB1408”. They are not compatible between HUB models or with eMIMO1616 configuration files.

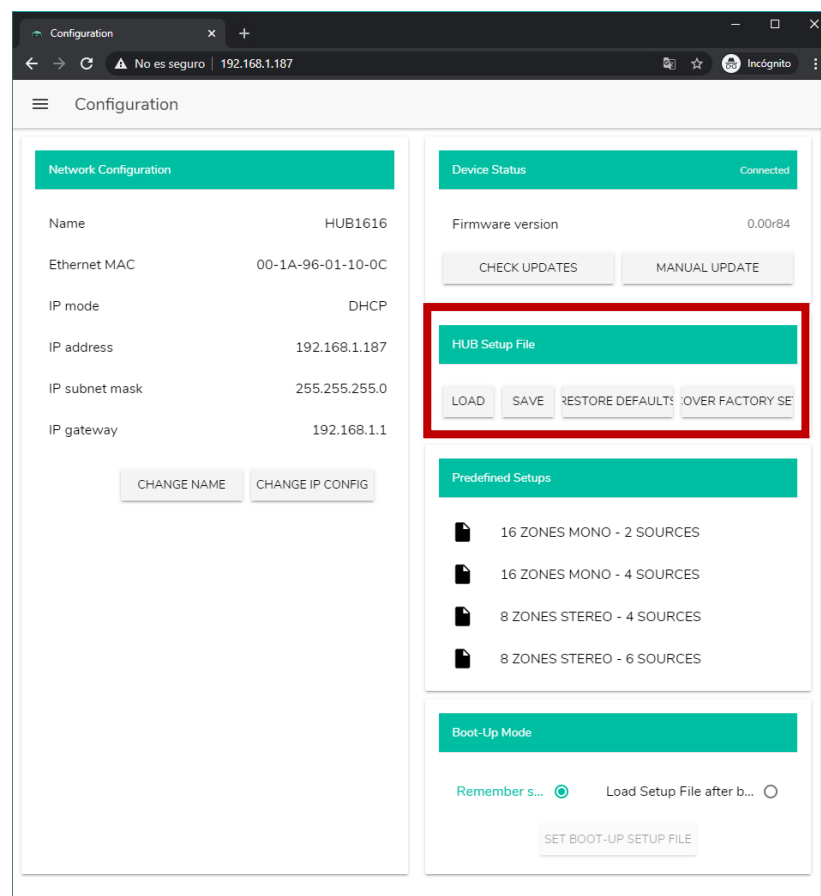

- **LOAD:** allows to load a previously saved configuration file. Clicking on LOAD opens a file browser. You must select a valid project file on your computer, for example “my_project.HUB1616”.
- **SAVE:** allows you to save the current configuration of the HUB device. Enter a name for the file: “my_project”, for example. After clicking save, a file “my_project.HUB1616” will start downloading in the download folder configured in your computer's browser.
- **RESTORE DEFAULTS:** sets the device to its default values. No Internet connection is required by the HUB device to retrieve this file. See chapter [RESTORE DEFAULTS](#) for more details about the default parameters.
- **RECOVER FACTORY SETUP:** sets the device to its factory settings. The factory setting corresponds to the first predefined setups. In the case of the HUB1616: 16 ZONES MONO - 2 SOURCES. In the case of the HUB1408: 8 ZONES MONO - 2 SOURCES. See chapter [PREDEFINED SETUPS](#) for more information. An Internet connection is required by the HUB device to retrieve this configuration file. See chapter [APPENDIX](#) for more details on the factory settings.

14.4. PREDEFINED SETUPS

This box allows the loading of predefined setups. These are quick configuration files, which will allow a quick start up, starting from a predefined configuration and pilot control panels previously created. A predefined setup, after being loaded into the HUB device, can be modified to fit the user's needs. An Internet connection is required to access these settings.

These configuration files are also available through the Ecler Pilot application for the public profile, which allows a quick configuration using only a mobile device. This option can be disabled by the administrator.

Each model of the HUB series has its own configuration files, which are not compatible with each other.

See chapter [PILOT PANELS](#) for more details about the pilot control panels. See chapter [APPENDIX](#) for more detailed information about the parameters in these quick setup files.

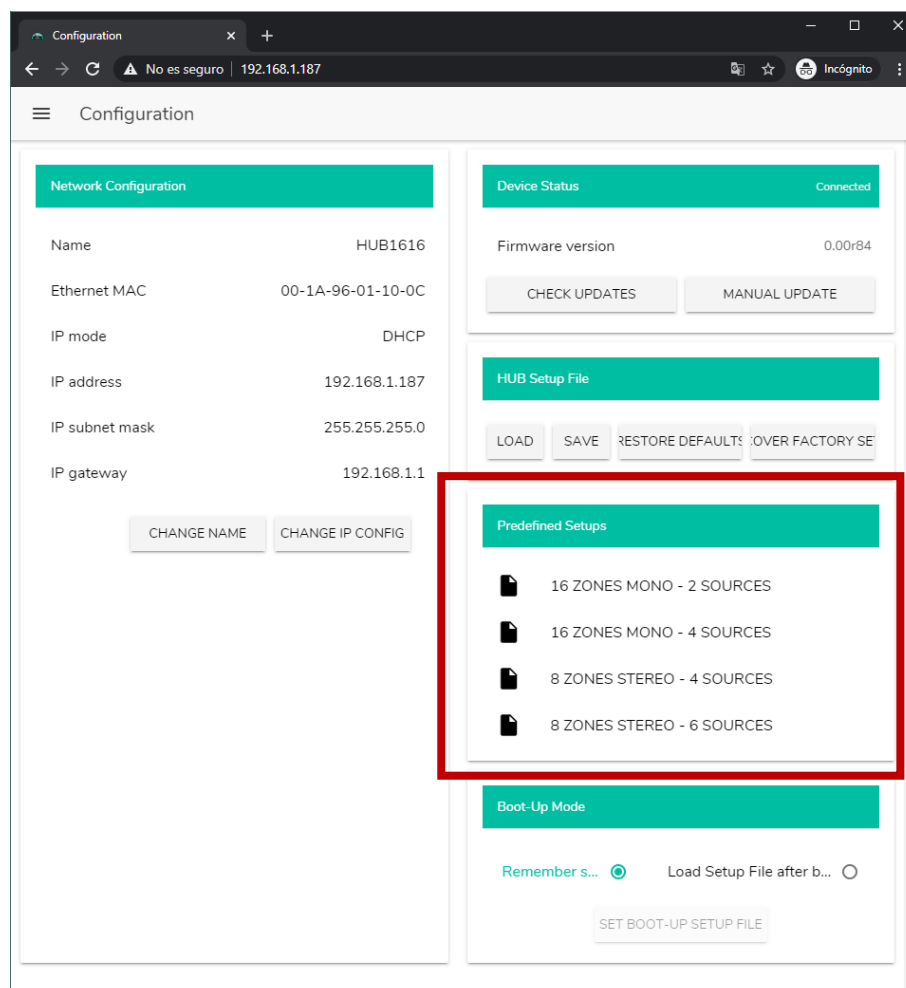

Figure 26: Predefined setups

14.5. BOOT UP MODE

This box manages the boot mode of the HUB device.

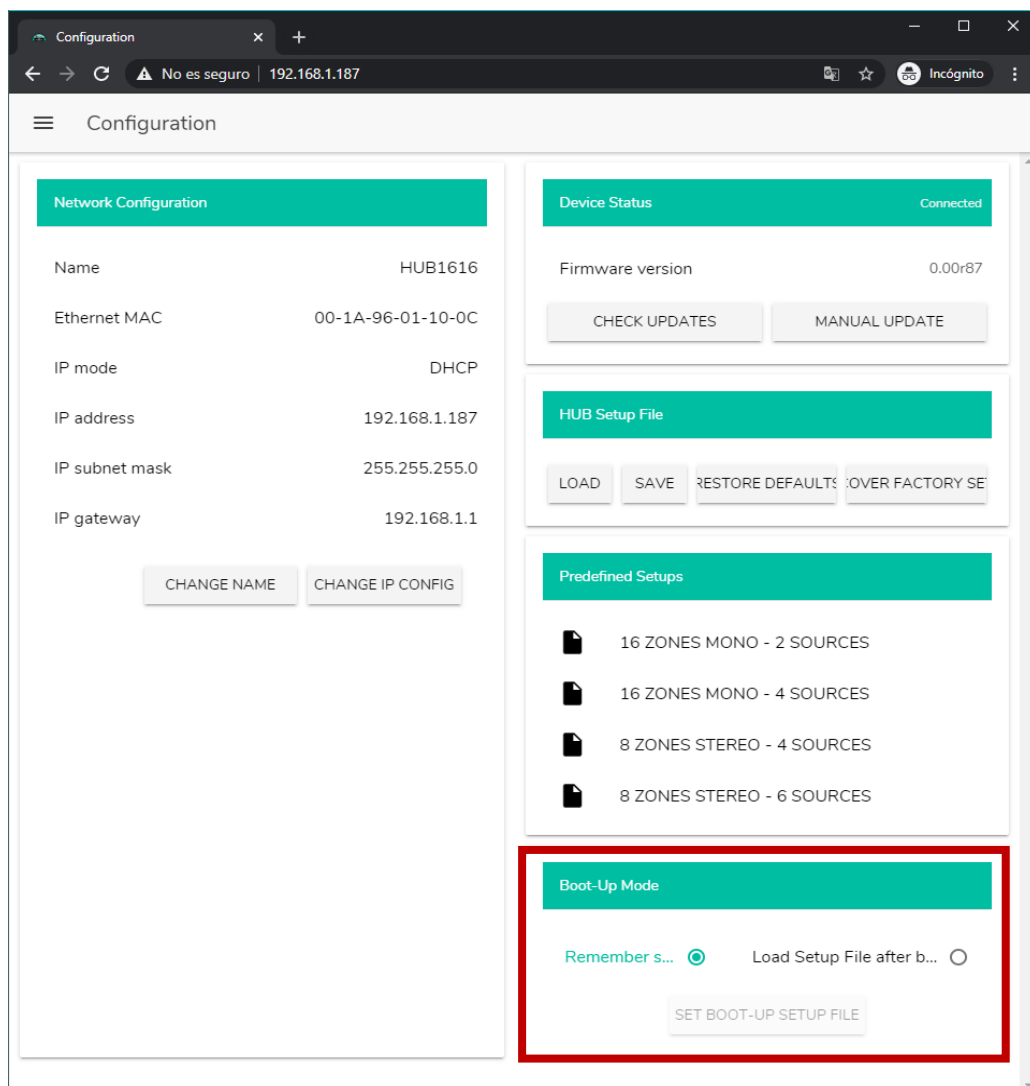

Figure 27: boot mode configuration

- **Remember status:** the device starts up with the settings it had just before it was turned off, including the status of volumes, selected sources, equalization settings, etc.
- **Load setup file after boot up:** allows you to load a configuration file right after booting, ignoring the configuration you had before shutting down. To select this project, select the "Load setup file after boot up" option and click on the "Set boot up setup file" button. The saved boot setup file will be the exact configuration of the HUB device at that time. This operation overwrites the previously configured boot project. If the "Load setup file after boot up" option is selected and no project has been configured, the device will remember the last configuration before it was shut down.

15. USERS

The USERS page allows the creation and management of the accounts of the different “client” users. Each user can access the HANGAR web application or mobile application (**Ecler Pilot**) with credentials assigned by the administrator: username and password. Access to the public profile does not require credentials.

A user, after accessing the application, will only display and manage those control panels and controls that have been assigned by the administrator on a certain zone/s. There are 3 types of control: volume, source selection and equalization. For more details on the control a user can exercise over the matrix, please refer to the chapter [PILOT PANELS](#).

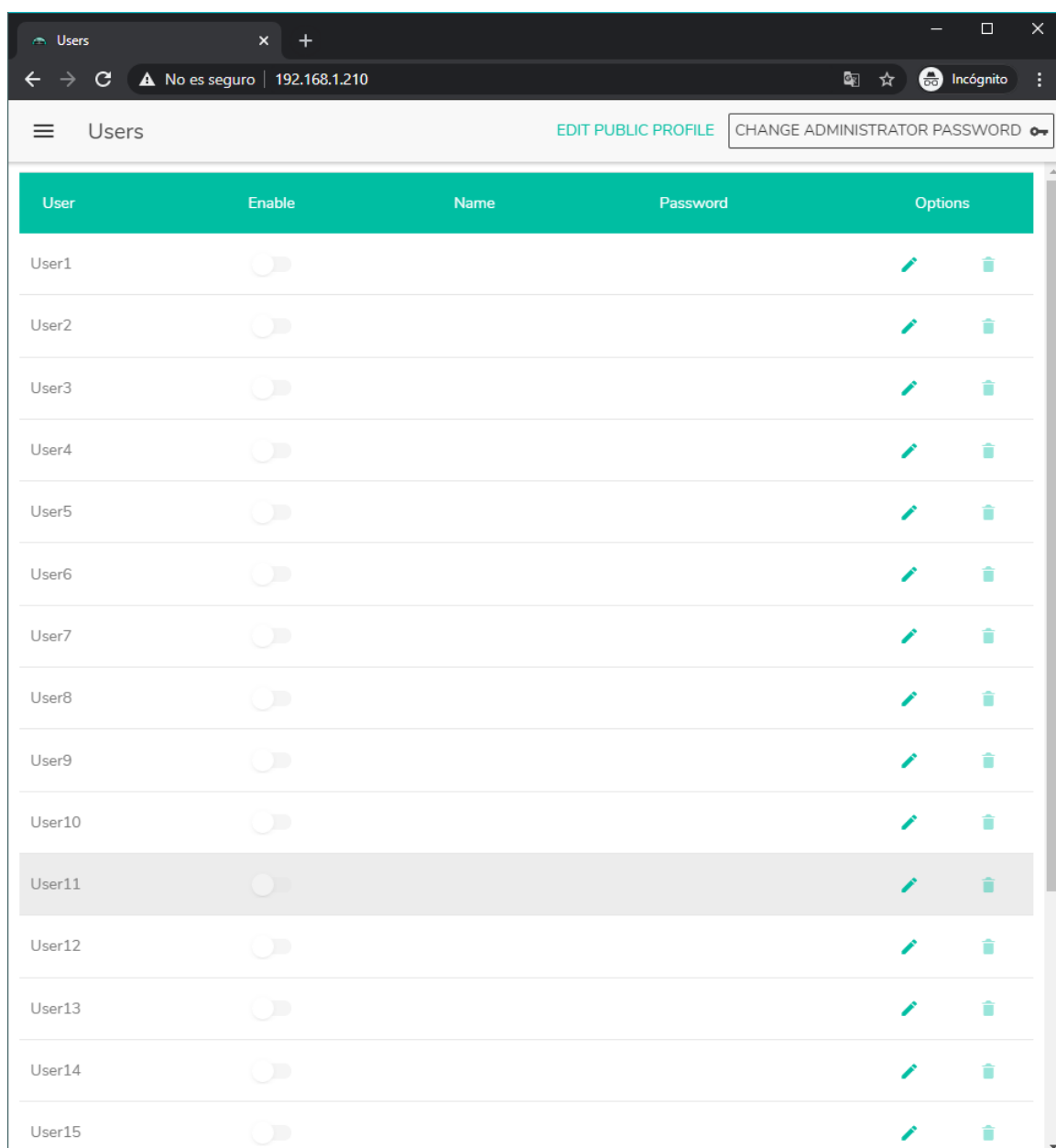

User	Enable	Name	Password	Options
User1	<input type="checkbox"/>			
User2	<input type="checkbox"/>			
User3	<input type="checkbox"/>			
User4	<input type="checkbox"/>			
User5	<input type="checkbox"/>			
User6	<input type="checkbox"/>			
User7	<input type="checkbox"/>			
User8	<input type="checkbox"/>			
User9	<input type="checkbox"/>			
User10	<input type="checkbox"/>			
User11	<input type="checkbox"/>			
User12	<input type="checkbox"/>			
User13	<input type="checkbox"/>			
User14	<input type="checkbox"/>			
User15	<input type="checkbox"/>			

Figure 28: user management page

You can edit up to 20 different users, each with their own credentials. To edit a user, click on the icon  to the right of the page. Enter the name, password, and enable it if you want to assign control panels to it (*pilot panels*, see chapter [PILOT PANELS](#) for more details).

You can enable or disable it later at any time.

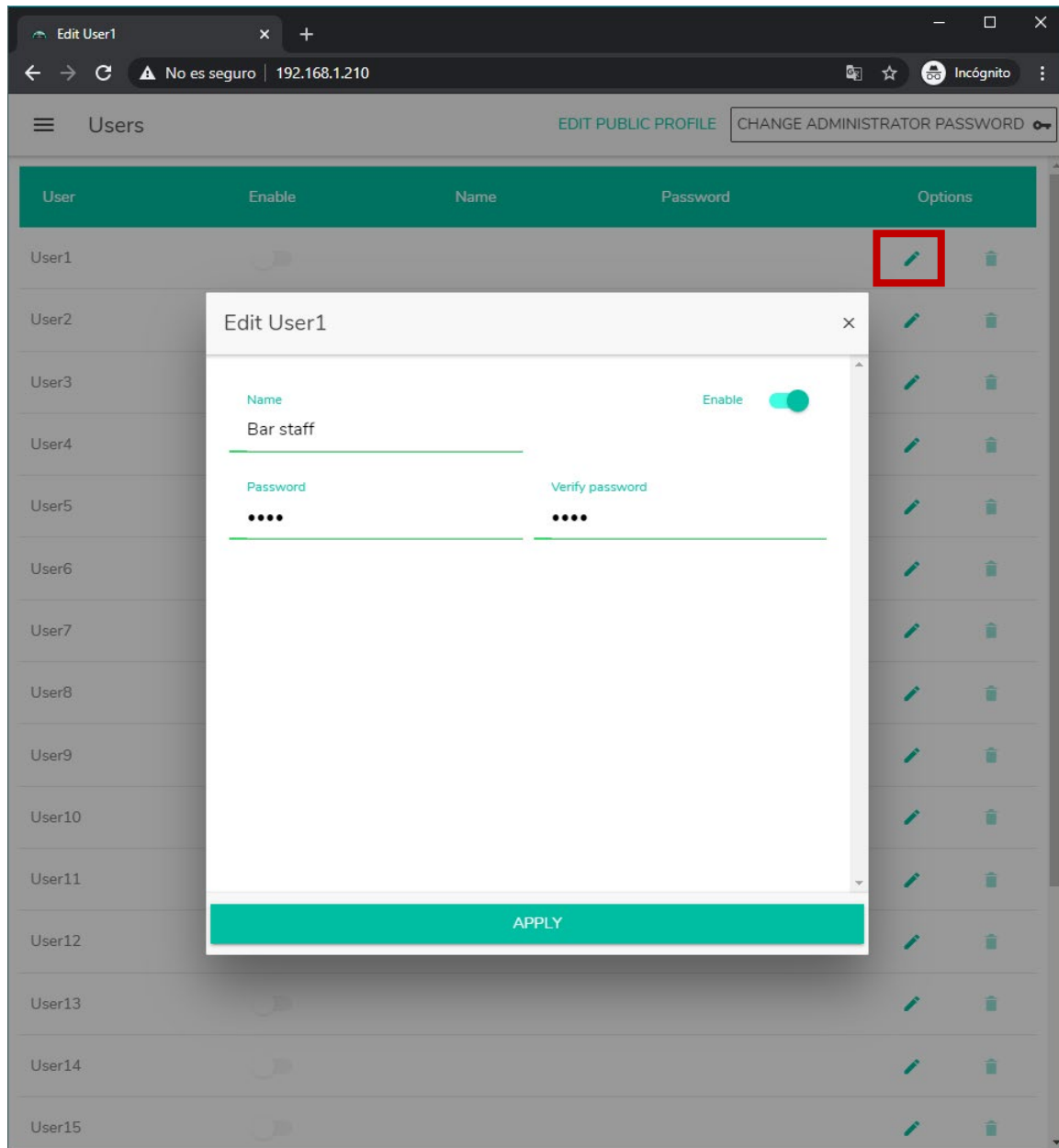



Figure 29: editing a user

To remove user credentials, select the icon  to the right.

15.1. EDIT PUBLIC PROFILE

Clicking on the “Edit public profile” button opens a dialog box with the options available for the public profile.

- **Allow loading predefined setups:** disable this option if you want that from the public profile (access without credentials) the default setups cannot be loaded and therefore, modify the device settings.

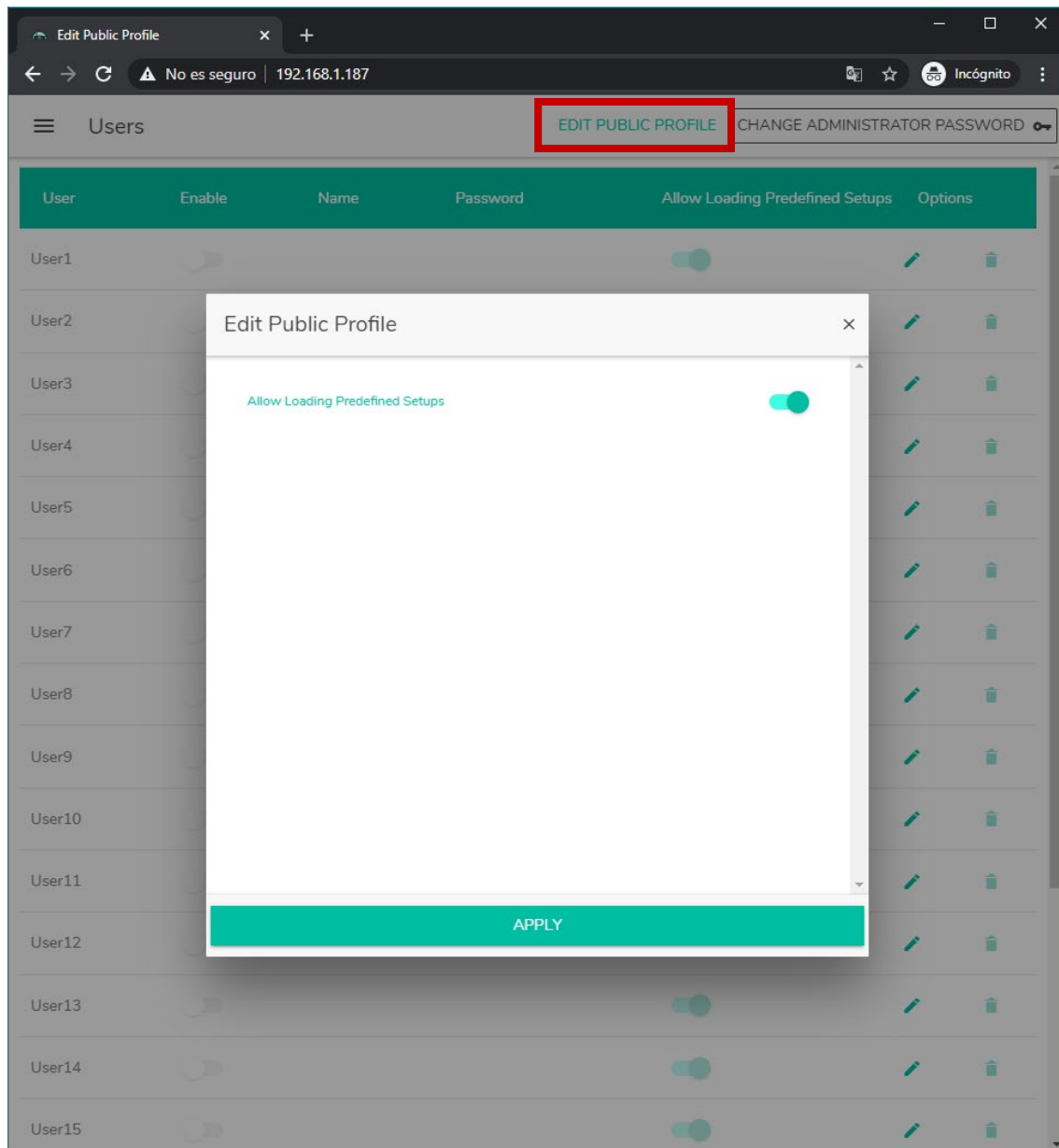

Figure 30: editing the public profile

Note: If there are enabled users, the “Allow Loading Predefined Setups” option will be disabled and will not be available until all users are disabled.

15.2. CHANGE ADMINISTRATOR PASSWORD

Under the “Change administrator password” button, you can change the access password as administrator, by default, admin.

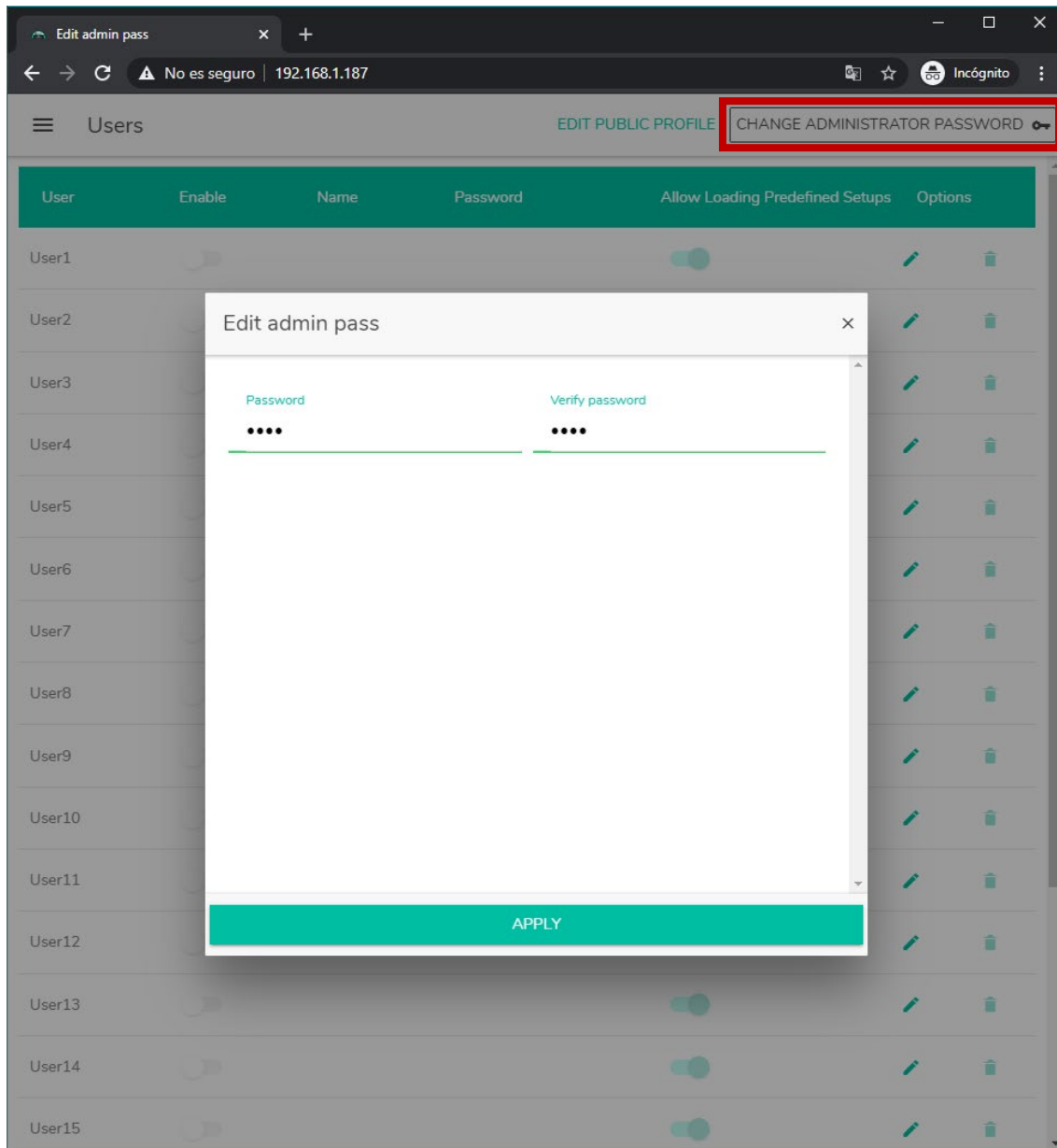

Figure 31: change administrator password

16. FRONT PANEL

On the FRONT PANEL page, you can set the lock of certain functions on the front panel of the HUB device. This allows you to be assured that the matrix configuration will not be altered by the end user, if desired. It will prevent tampering with the audio installation, making it more robust.

In addition, this page allows you to adjust the parameters and operation of the front panel LCD display.

16.1. ALLOWED CONTROLS

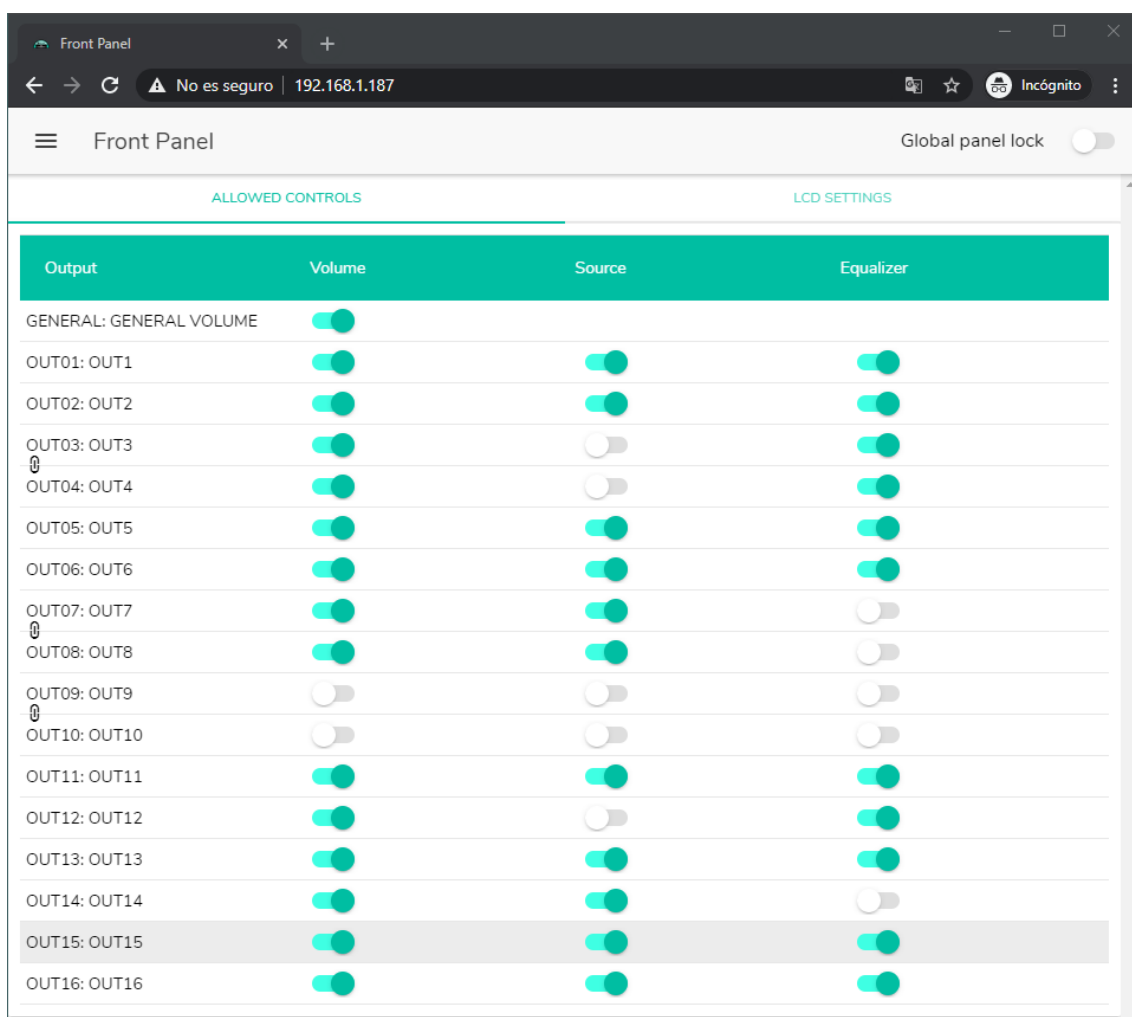

Figure 32: allowed controls on the frontal panel

The General Volume, which acts on all or selected zones, can be disabled for control from the front panel. It is accessed by a short press on the rotary **encoder** on the front panel.

For each zone, you can enable/disable manipulation from the front panel of:

- **Volume:** volume control of the audio signal in that zone

- **Source:** source selection for that area
- **Equalizer:** tone control (bass-middle-treble) of the selected signal in that area

Thus, observing the example of the Figure 32, from the front panel you cannot manipulate the equalization of zone 14 (OUT14). However, it is allowed to control the volume of the zone, as well as the selection of the audio source.

16.2. GLOBAL PANEL LOCK

By enabling the Global Panel Lock option (top-right corner), **ALL** front panel manipulation options are locked, turning the device into a “black box” facing the end user.

You can always check the device information: by holding down the CTRL + rotary encoder keys. This function is not disabled.

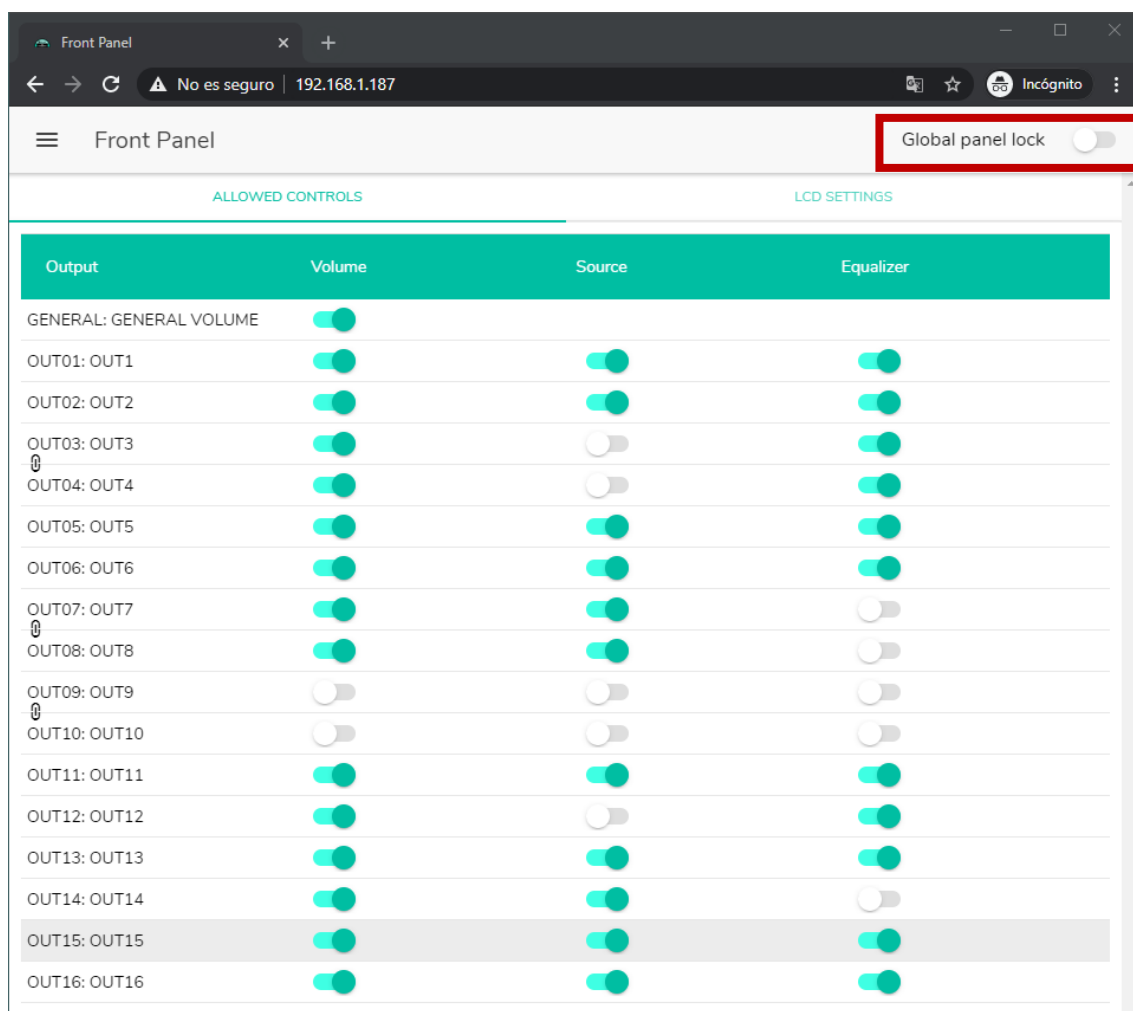

Figure 33: locking all front panel options

16.3. LCD SETTINGS

Here you can set the behavior of the LCD display:

- **NORMAL:** The display remains on at all times.
- **DIMMED:** After 30 seconds of inactivity, the display dims. It returns to its normal state as soon as some control on the front panel is manipulated.
- **OFF:** After 30 seconds of inactivity, the display turns off (minimum brightness). It returns to its normal state as soon as some control on the front panel is manipulated.

You can also adjust the display brightness (Backlight) and contrast (Contrast) in NORMAL mode.

In addition, the “Default zone selection” option allows for automatic selection, after a few seconds of inactivity (10 sec.) of:

- **LAST ZONE:** the last zone selected. It shows again on the screen the controls of the last selected zone, after modifying the general volume.
- **GENERAL VOLUME:** the general volume. It displays the general volume control again, after modifying any parameter of a zone.

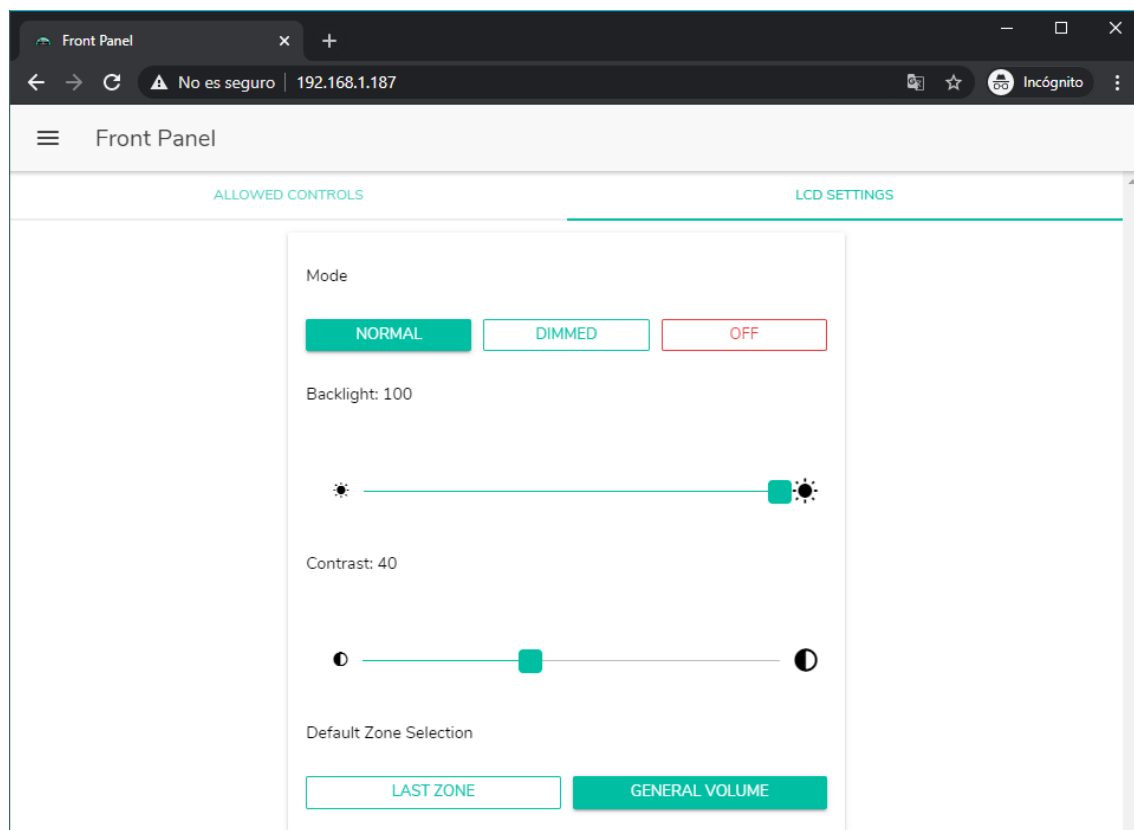

Figure 34: screen options

17. INPUTS

On the INPUTS page, the audio sources are configured, i.e. each of the audio inputs available to the HUB unit.

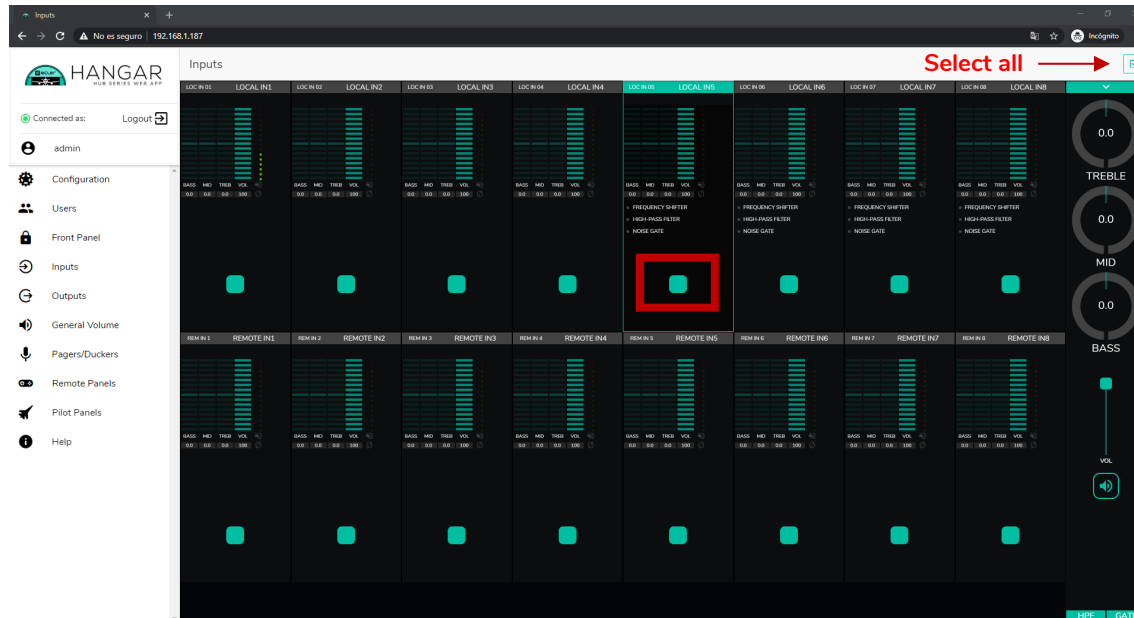



Figure 35: INPUTS HUB1616 page

To select an input, click on the central button of that input (see Figure 35). When an input is selected, it changes color, indicating that it is selected.

If you want to edit several inputs at once, you can select several by holding down your radio button for a moment. To select all inputs, click on the SELECT ALL icon in the upper right corner: 

Note: you can select several inputs using the keyboard shortcut: by pressing the CONTROL key, and without releasing it, select the inputs by clicking the left mouse button. You can also deselect an input by selecting it while holding down the CONTROL key. In addition, you can make a quick selection of several contiguous inputs by clicking from the first to the last one while holding down the SHIFT key. For example, if you want to select inputs 1 to 8: while holding down the SHIFT key, click with the mouse first on input 1 and then on input 8.

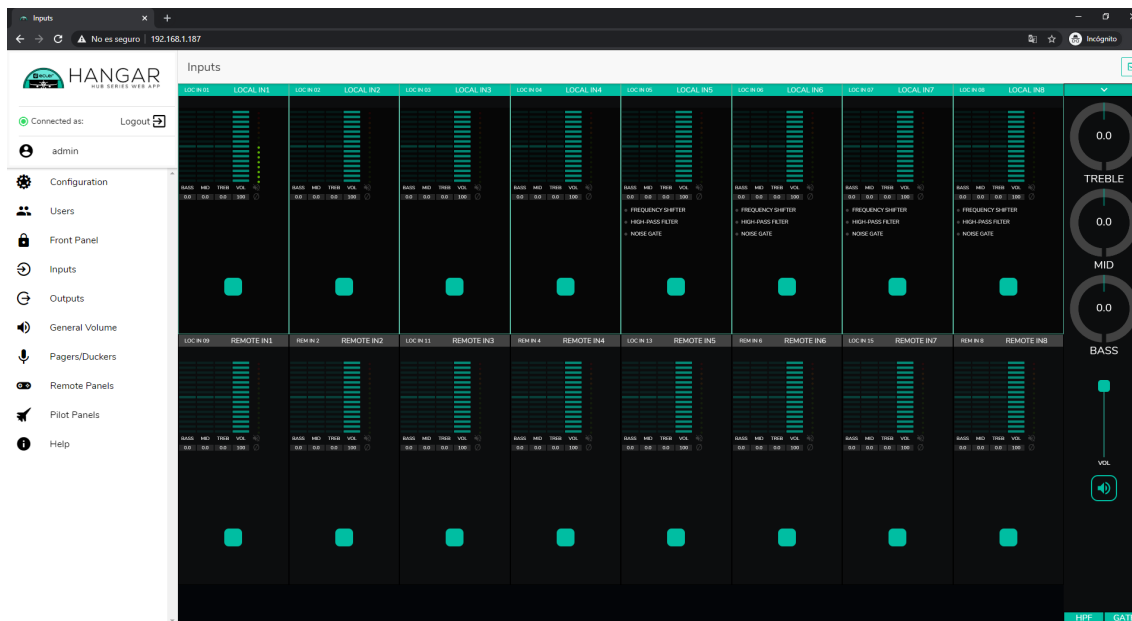
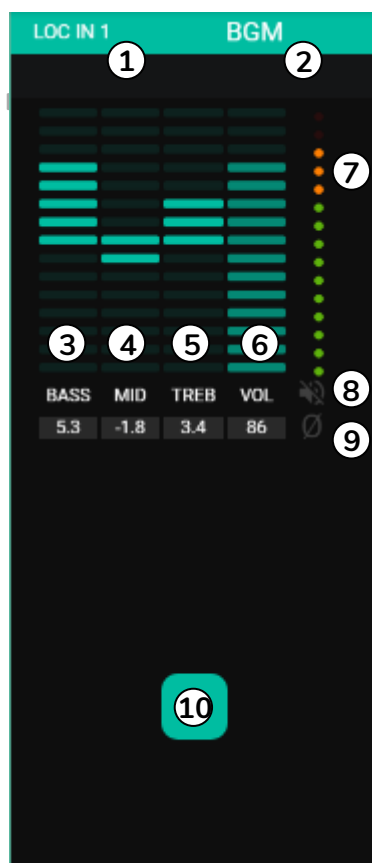

Figure 36: selection of several inputs

Each input shows a summary of its current configuration:



1. Local input indicator, connectors on the rear panel (LOC) or remote (REM), remote control panels with audio input, plus the corresponding numbering.
2. Input label (editable).
3. Graphic and numeric levels of the bass tone control. The center position corresponds to 0: no enhancement or attenuation.
4. Graphic and numerical levels of the mid-tone control. The center position corresponds to 0: no enhancement or attenuation.
5. Graphic and numeric levels of the treble tone control. The center position corresponds to 0: no enhancement or attenuation.
6. Graphical and numerical levels of the volume control.
7. Vumeter (VU) indicating the audio signal level at the input. The red LEDs indicate a saturation (CLIP) of this signal (last 2 LEDs of the VU).
8. MUTE indicator. If lit, this indicates that the input has been muted.
9. Polarity indicator. If it is illuminated it indicates that the phase of the signal has been inverted with respect to the original.
10. Input selection button.

In addition, the microphone/line inputs, local inputs from IN5 to IN8 on HUB1616 and local inputs from IN3 to IN6 on HUB1408, have active function indicators: FREQUENCY SHIFTER, HPF (high-pass filter) and GATE (noise gate). A green LED indicates that the function is enabled. The green LED indicates that the device is connected. For more information, please refer to sections [FREQUENCY SHIFTER](#), [HPF](#) and [GATE](#) of this chapter.

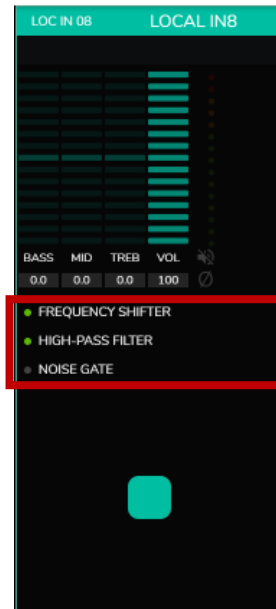

Figure 38: DSP indicators active on inputs

To edit these parameters, on the right of the INPUTS page, the necessary controls are always visible.

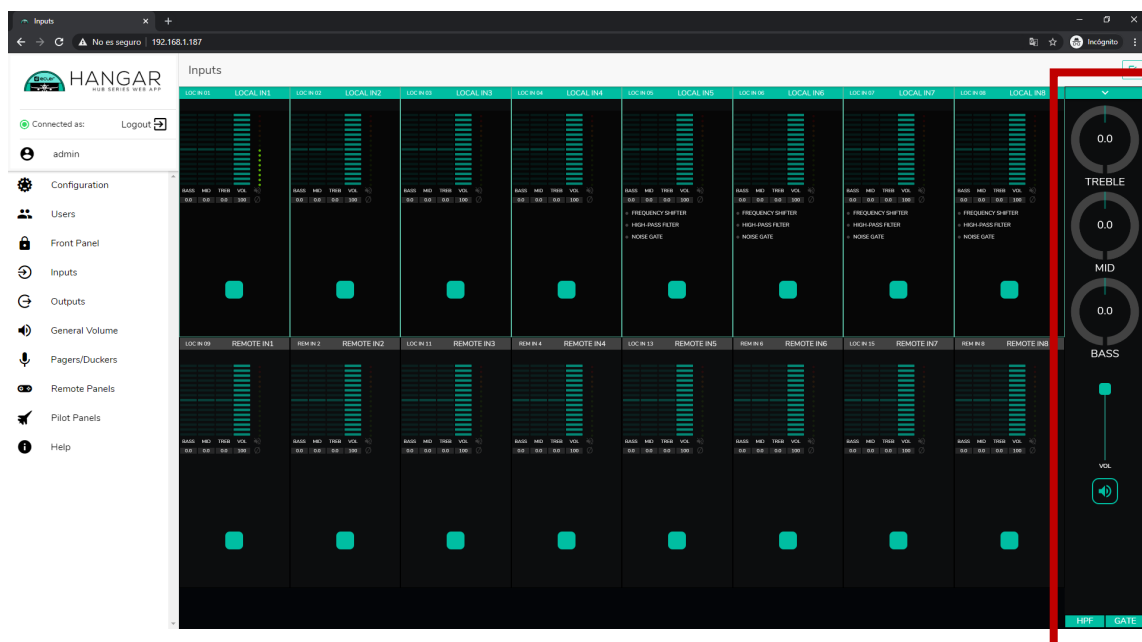
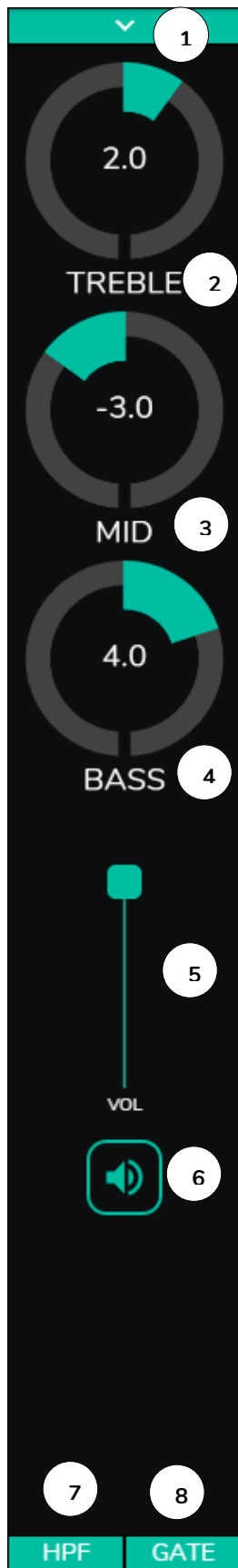

Figure 39: input control and editing



1. Drop-down menu showing the options for POLARITY, STEREO, FREQUENCY SHIFTER and LABEL edition.
2. Tone control setting: treble (6.3kHz). A long press on the control adjusts it to its central position.
3. Tone control adjustment: mid (1kHz). A long press on the control adjusts it to its central position.
4. Tone control setting: bass (200Hz). A long press on the control adjusts it to its central position.
5. Volume control adjustment.
6. MUTE: Mute the input signal.
7. Drop-down list showing the high-pass filter (HPF) setting. Only available for microphone inputs.
8. Drop-down list showing NOISE GATE settings. Only available for microphone inputs.

Note: Click to the right of any potentiometer-shaped control (rotary), or to the top of the fader-shaped control (slider), to increase its value by 0.1 (fine adjustment). Click to the left of the potentiometer knob, or to the bottom of the slider knob, to decrease its value by 0.1 (fine tune). Click on any control while holding down the CONTROL key on the keyboard, or long press the control to set its default value.

Figure 40: input controls

17.1. CHANGE LABEL

It allows to edit the name of the input signal.

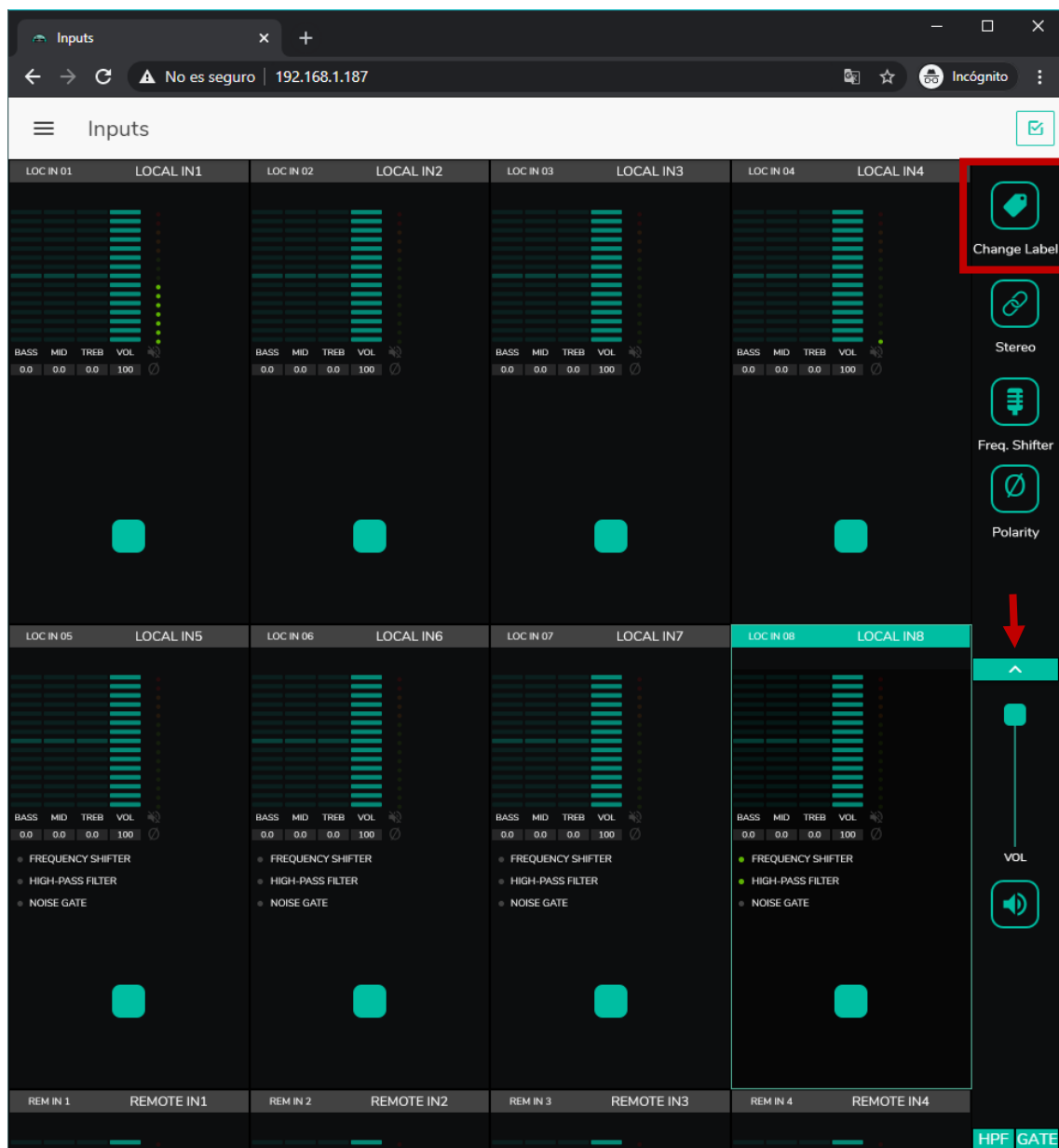

Figure 41: changing the input's name

17.2. STEREO

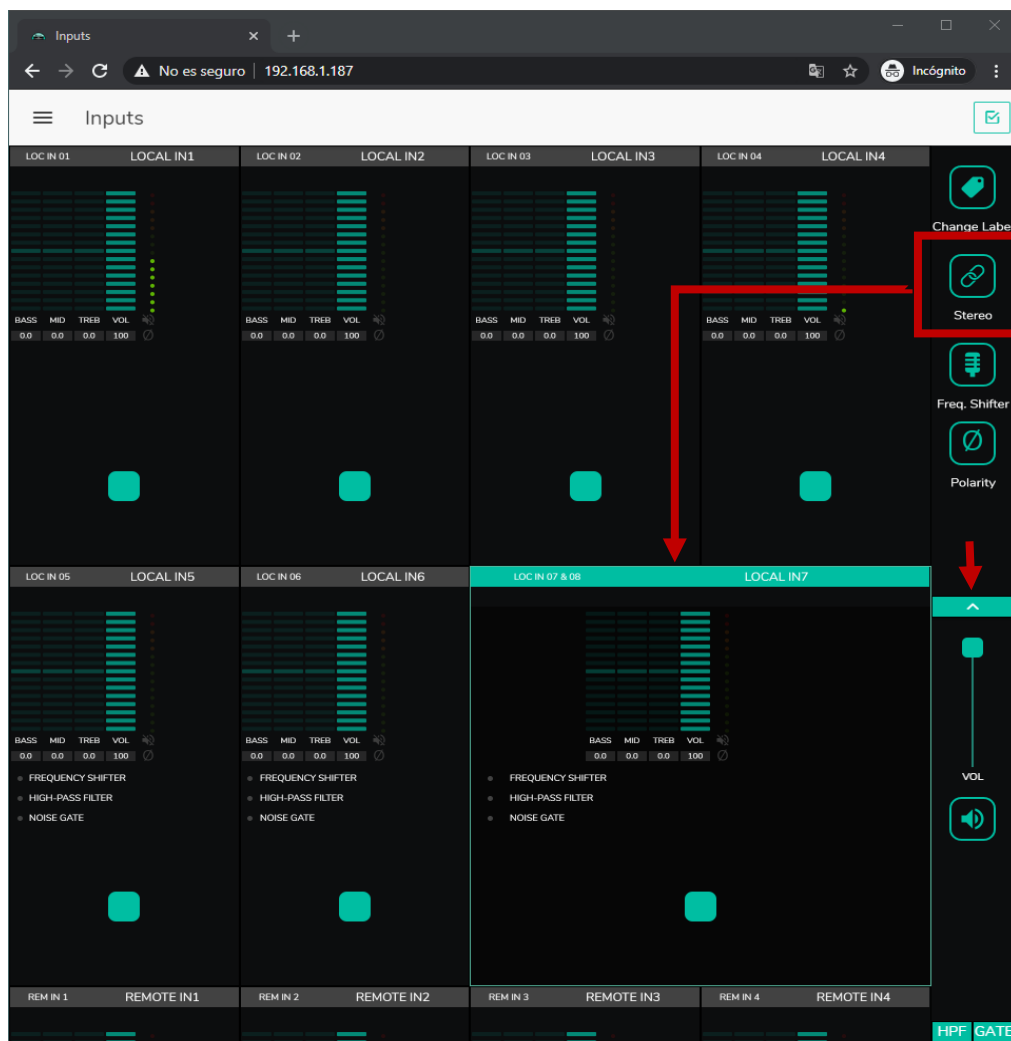

Figure 42: conversion of 2 mono inputs to a stereo one

You can convert 2 balanced mono inputs (micro/line inputs) into a stereo pair using this control. The 2 graphic representations of both mono inputs are converted into a single one, which shows the information of the pair. In addition, automatically, if assigned to an output that is also configured in stereo, the odd input is routed to the odd output, and the even input is routed to the even output (left to left and right to right). In the same way, any adjustment made to any of the 2 inputs (duckers, EQ, volume, DSP, etc.) will affect both. This option is only available for the balanced micro/line inputs of the device: local inputs from IN5 to IN8 in HUB1616 and local inputs from IN3 to IN6 in HUB1408.

Note: If a stereo input is assigned to a mono output, the HUB unit automatically performs the stereo to mono (L+R) conversion. If a stereo input is assigned to a stereo output, both outputs will contain the same audio source (double mono), but the same processing will be applied.

17.3. FREQUENCY SHIFTER

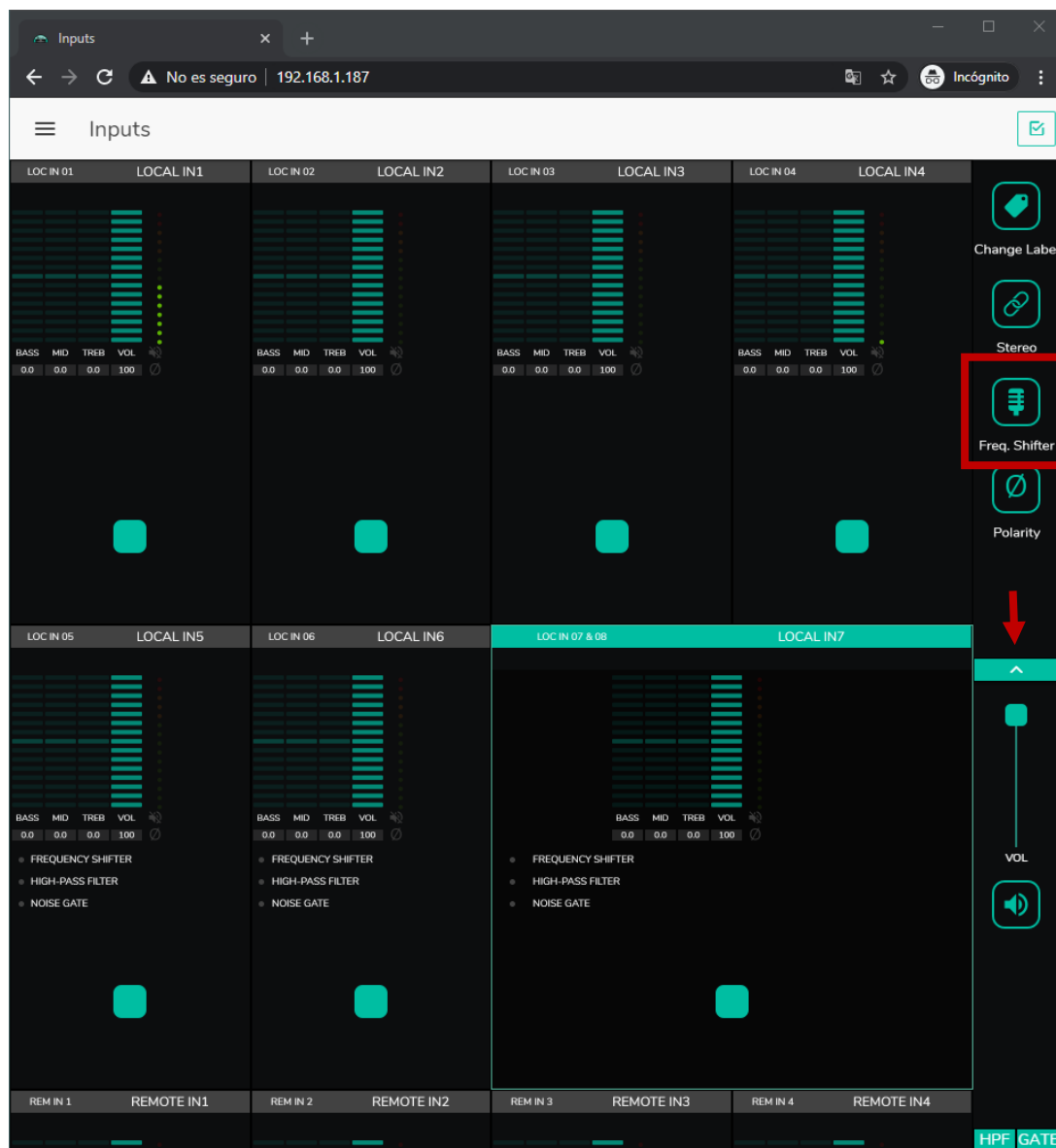

Figure 43: enabling the feedback canceller (FREQUENCY SHIFTER)

It allows to activate the feedback canceller, an efficient system to reduce the possibilities of feedback loops (couplings, Larsen effect) when a microphone source is close to the speaker or speakers that broadcast its signal, once amplified. When activated, this function performs a slight frequency shift of the incoming signal on the affected channel (Frequency Shifter), before sending it to the outputs to which it has been routed. The shifting is so slight that it becomes barely noticeable to the listener, especially when it occurs in the frequency range of the human voice. A few cycles (Hz) of shifting are sufficient to greatly increase the system's protection against feedback.

17.4. POLARITY

Polarity change of the input signal It can be useful to fix phase problems.

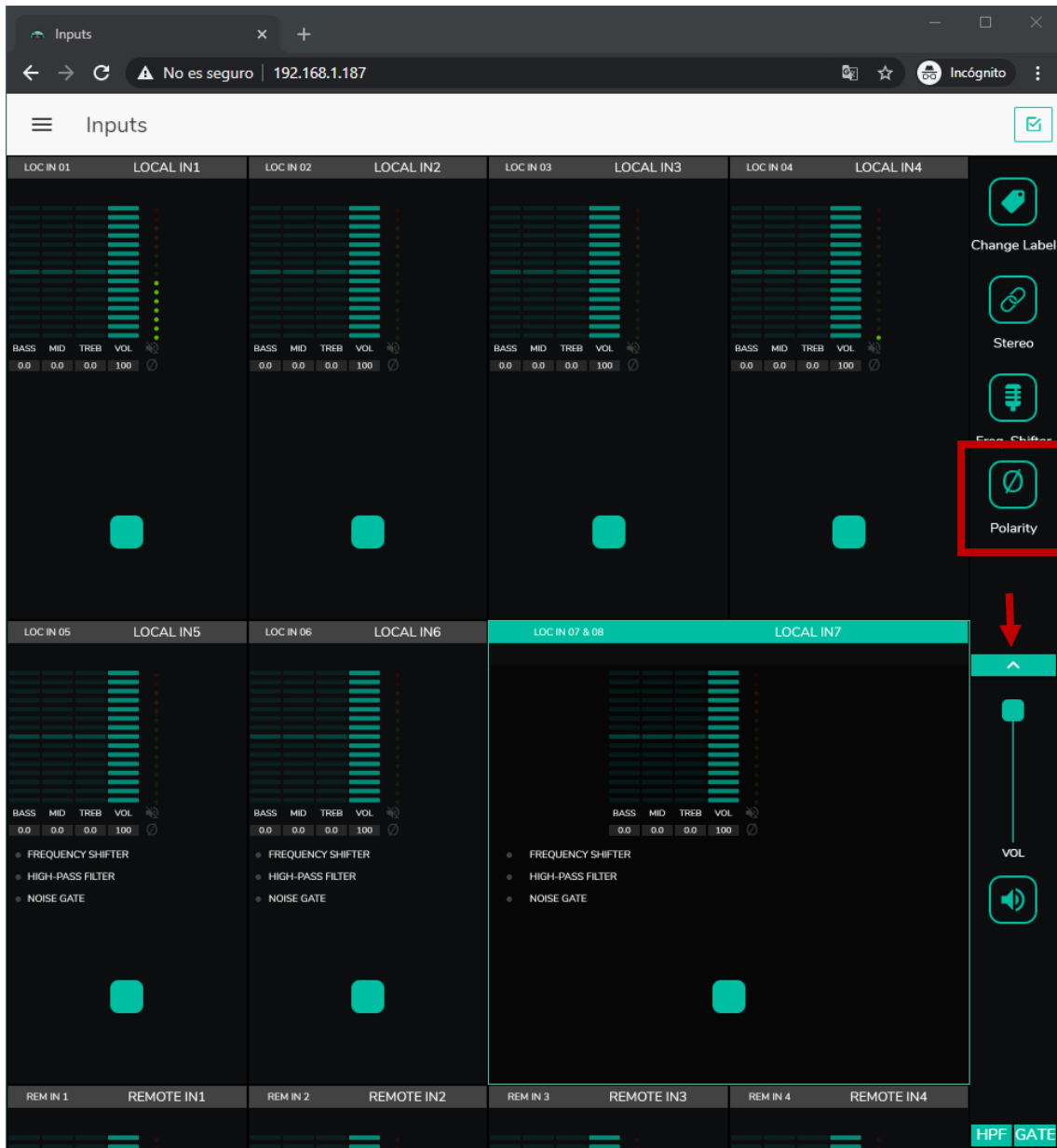
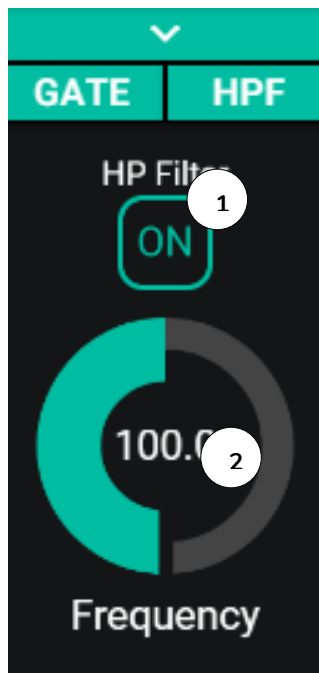

Figure 44: Polarity change of the input signal

17.5. HPF



Useful for attenuating the proximity effect of a microphone (boost at low frequencies) or eliminating/attenuating background noise, handling noise, etc:

1. ON/OFF: activates/deactivates the high-pass filter
2. Frequency: Filter cut-off frequency. Selectable from 50Hz to 150Hz.

Figure 45: high-pass filter configuration of an input

17.6. GATE

Noise gate Useful for attenuating or eliminating background noise picked up by a microphone (or other audio source particularly sensitive to noise due to interference, etc.) by discriminating between background noise and valid audio signal:

1. ON/OFF: activates/deactivates the noise gate When in OFF mode the rest of the controls in this section are disabled.
2. THRESHOLD: detection threshold. This defines the input signal level below which the signal will be affected by the attenuation marked by DEPTH (gate closed). The range of this parameter is from -80dB to +12dB.
3. DEPTH: attenuation applied to the signal when it is below the detection threshold (gate closed). The range of this parameter is from 0dB to +80dB.
4. ATTACK: attack time. It determines the time from the threshold being exceeded to the cancellation of the attenuation applied to the input signal (gate open). Adjustment range from 0.1ms to 500ms.
5. HOLD: holding time, in which the gate is still open (no attenuation) once the signal falls below the detection threshold again. Adjustment range from 10ms to 3 seconds.
6. RELAX: Relaxation time. Determines the time it takes for the door to close again after the hold time has elapsed. In this case, the range covers from 10ms to 1 second.

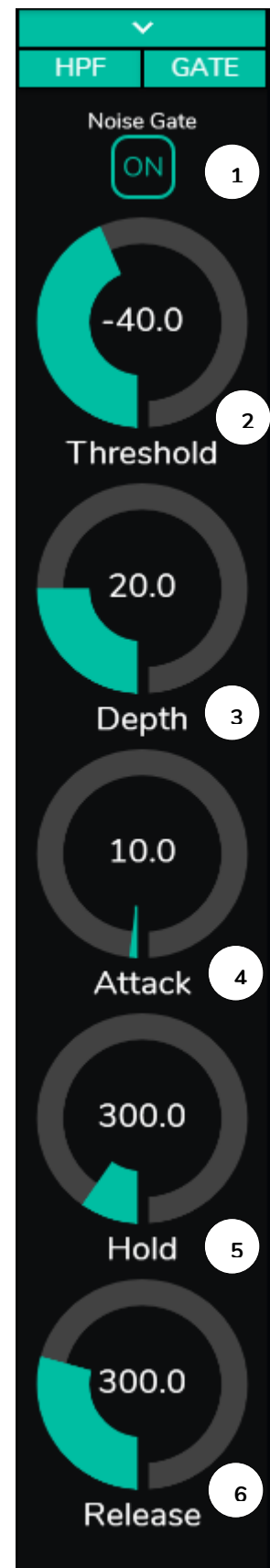

Figure 46: noise gate configuration of an input

18. OUTPUTS

The OUTPUTS page allows you to configure the audio outputs of the HUB devices. The graphical interface and operation is identical to the INPUTS page, with a few exceptions.

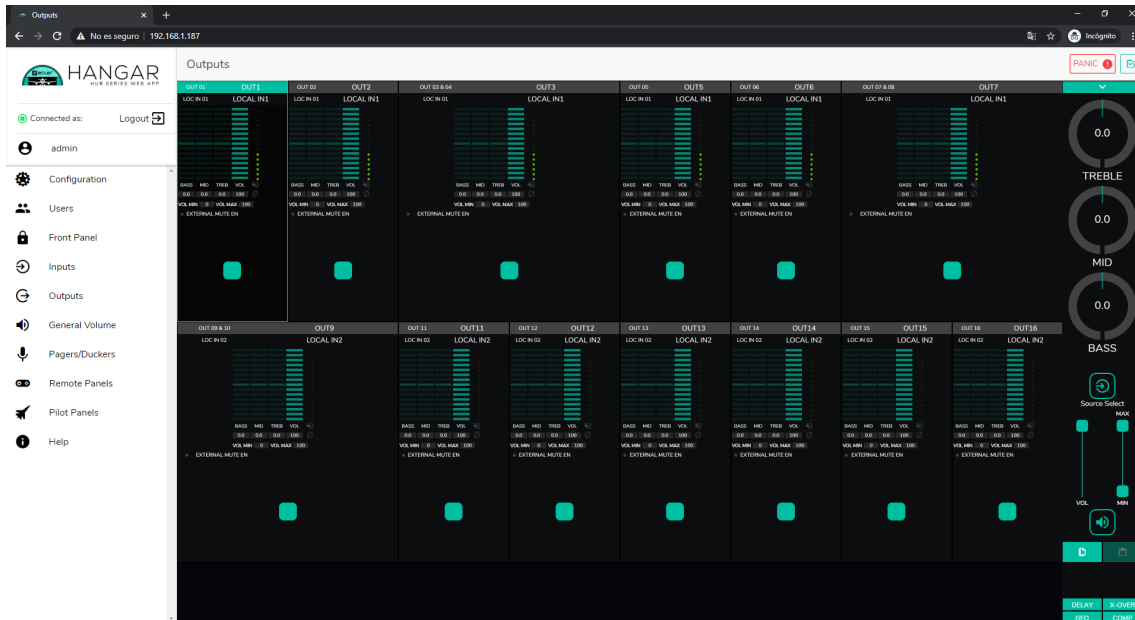

Figure 47: HUB1616 output configuration page

Each output displays a summary of its current configuration. The outputs have the same information as the inputs (except for the noise gate and the high-pass filter), plus:

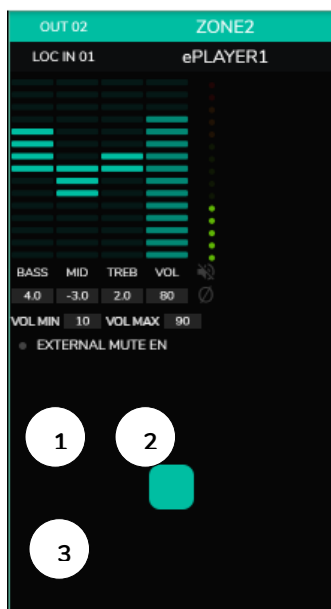
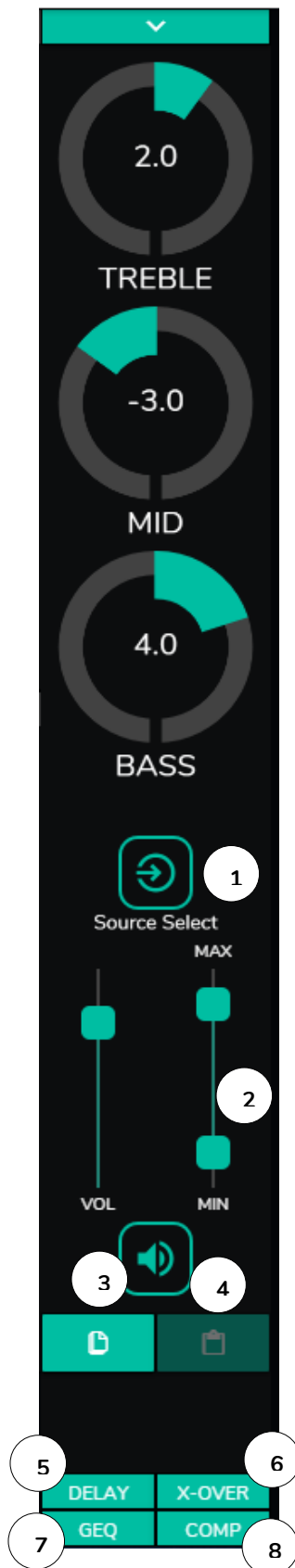

Figure 48: output representation

1. VOL MIN: minimum volume allowed for this output (adjustable).
2. VOL MAX: maximum volume allowed for this output (adjustable).
3. External contact closure MUTE function (connected to the MUTE port on the rear panel) enabled/disabled: an orange LED indicates that the function is enabled.

Note: End users can only adjust the volume of a zone (output) within the range VOL MIN - VOL MAX.

To edit these parameters, on the right of the OUTPUTS page, the necessary controls are always visible.



1. Source selection: allows you to select any of the 16 inputs available for the selected output.
2. Maximum and minimum volume: allows you to define the range between the maximum and minimum volume that can be adjusted in that zone using the corresponding volume control.
3. Copy DSP Configuration: Allows you to copy the DSP configuration (DELAY, X-OVER, GEQ and COMP) of an output.
4. Paste DSP configuration: allows you to paste the DSP configuration (DELAY, X-OVER, GEQ and COMP) previously copied from one output to another.
5. Drop-down list showing the delay configuration (DELAY). Available for outputs 1 to 8 in all HUB devices.
6. Drop-down list showing the crossover filter configuration (X-OVER). Available for outputs 1 to 8 in all HUB devices.
7. Drop-down list showing 8-band graphic equalizer (GEQ) settings. Available for all outputs.
8. Drop-down list showing compressor / limiter (COMP) settings. Available for all outputs.

Figure 49: output controls

By clicking on the drop-down list (as with the inputs), the options available for an output are displayed.

18.1. STEREO

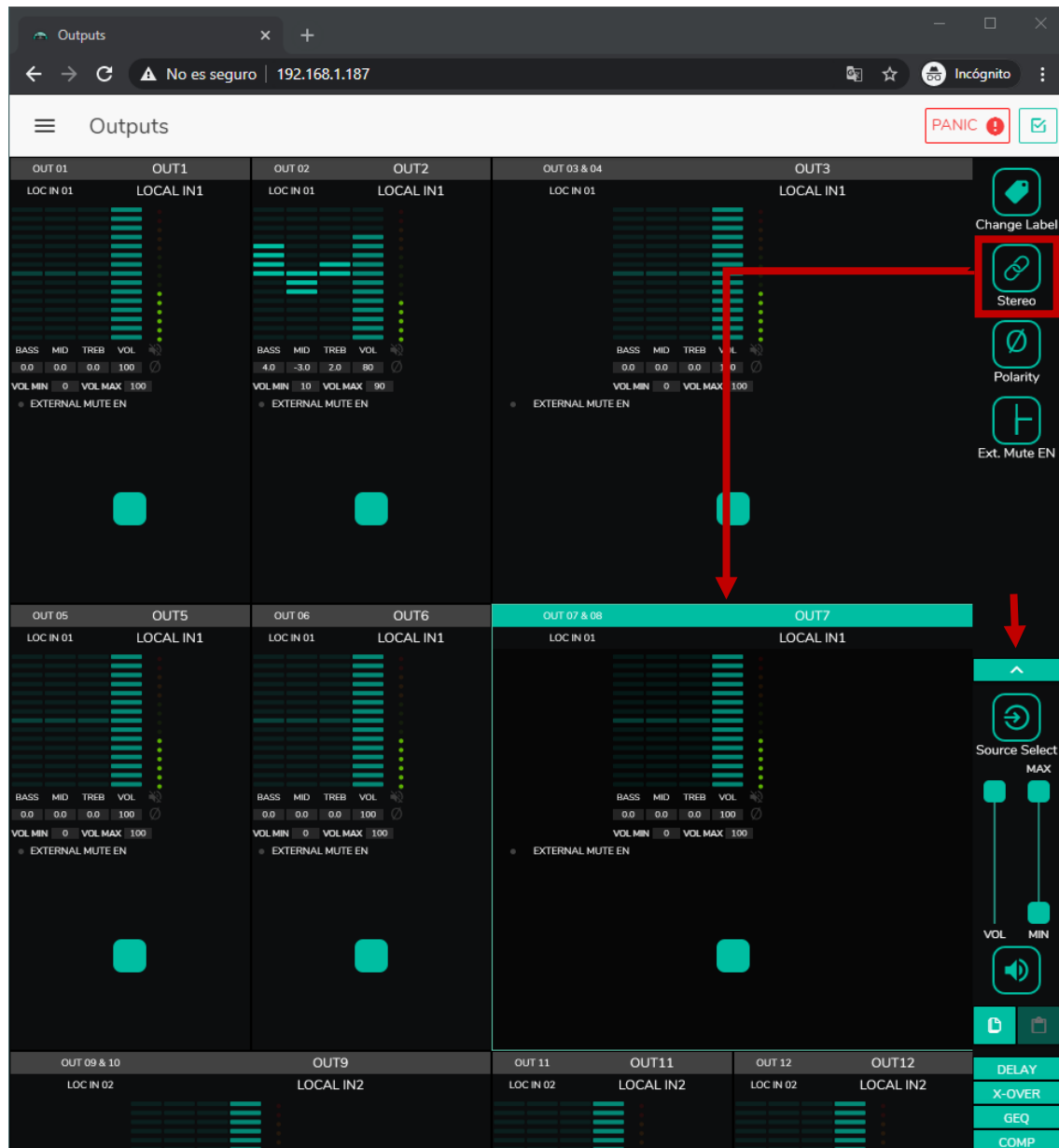

Figure 50: outputs configured as a stereo pair

You can convert 2 mono outputs into a stereo pair (natural pairs: 1-2, 3-4, etc.) using this control. The 2 graphic representations of both mono outputs are converted into a single one, which shows the information of the pair. Moreover, automatically, if you assign a stereo signal as input, the left channel is directed to the odd output, and the right channel to the even output (left to left and right to right). In the same way, any adjustment made to any of the 2 outputs (duckers, EQ, volume, DSP, etc.) will affect both.

Note: If a stereo input is assigned to a mono output, the HUB device automatically performs the stereo to mono (L+R) conversion. If a stereo input is assigned to a stereo output, both outputs will contain the same audio source (double mono), but the same processing will be applied.

18.2. EXTERNAL MUTE EN

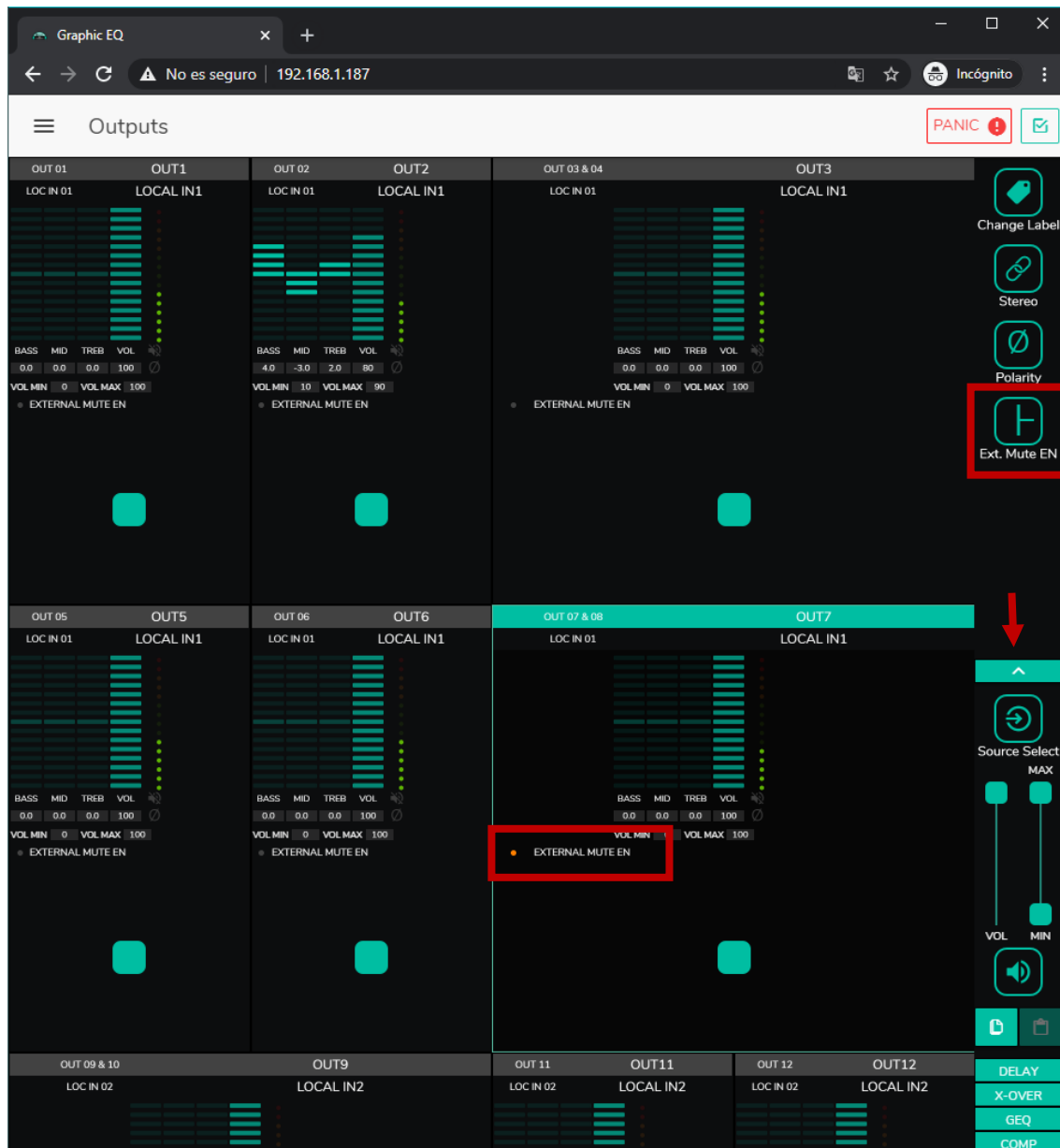
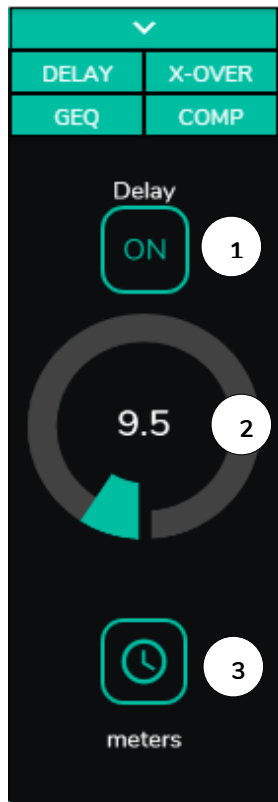

Figure 51: activation of external mute by contact closure on one output

Enables or disables muting (MUTE) of the output by external dry contact closure (NO, normally open), connected to the rear panel MUTE port. Useful for connection to fire detection systems, emergencies, alarms, etc. The priority modules that send messages to this area will also be muted in this area, while the contact closure is active.

18.3. DELAY



It allows the adjustment of a delay in milliseconds, meters or feet, to be applied between its input and output. It is independent for each output. Useful to adjust sound reinforcement systems that use reinforcement speakers far from the main system and avoid delaying signals to the audience. Available for outputs 1 to 8 in all HUB devices.

1. ON/OFF: activates/deactivates the delay
2. Adjusting the amount of delay
3. Selection of the delay parameter:
 - Milliseconds: 0 to 300ms
 - Meters: from 0 to 103m
 - Feet: 0 to 338 feet

Figure 52: setting the delay

18.4. X-OVER



Allows you to insert a crossover filter (low pass or high pass) on the selected output. It is independent for each output. Useful if you connect a sub-bass to this output, for example. Available for outputs 1 to 8 in all HUB devices.

1. ON/OFF: activates/deactivates the filter
2. Filter type selection: low pass (LPF) or high pass (HPF)
3. Selecting the filter cut-off frequency

Figure 53: setting a crossover filter

18.5. GEQ

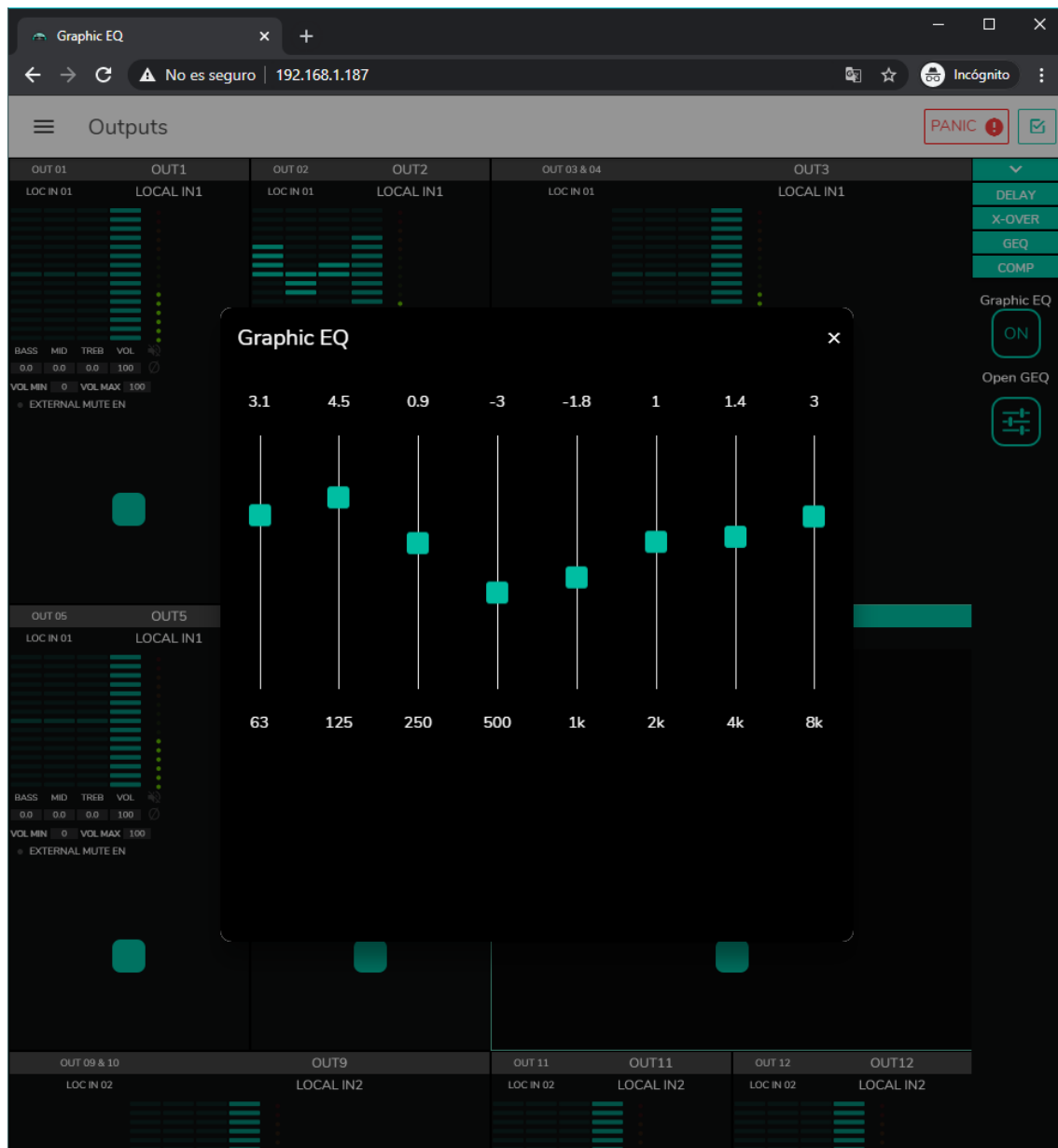

Figure 54: setting the graphic equalizer on an output

Allows you to set up an 8-band graphic equalizer at the output. Each band allows a ± 10 dB adjustment.

It is independent for each output and available in all of them.

Note: when the graphic equalizer is activated on an output, the tone control will be disabled for that output. If a pilot panel has been created with the tone control for the zone, it will be inactive. This is also true for the wall panels and the front panel, indicating that the graphic equalizer is active.

18.6. COMP

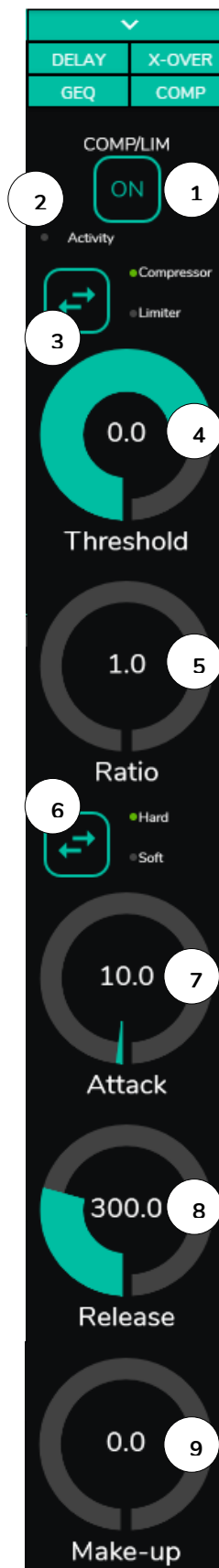

Figure 55: setting an output compressor

It offers a treatment on the dynamic behavior of the output signal, allowing to control the output intensity to avoid that it exceeds certain levels. Useful for limiting the output level in an area, for example. It is independent for each output and available in all of them.

1. ON/OFF: activates/deactivates the compressor
2. Activity LED: The activity LED lights up when the output signal exceeds the set threshold. It indicates that the compressor is running. Adjust the threshold so that the Activity LED lights up occasionally, coinciding with the peaks of the output signal.
3. Compressor/limiter mode selection. When selecting the limiter mode, reset the compressor parameters to act as a limiter (Ratio = inf., for example).
4. THRESHOLD: Compression threshold used to specify the input signal level at which compression begins to occur. The range of this parameter is +12dB to - 36dB
5. RATIO: compression ratio. It specifies in what proportion the output signal volume is reduced by increasing the input signal level above the threshold. The value 1:1 states that the signal level will remain unchanged, while the extreme value inf:1 represents a signal limiter, in which any signal above the threshold will be contained at that threshold level.
6. KNEE: determines how compression will be applied in the transition zone or "bend", once the compression threshold is exceeded, in a progressive (soft) or more direct (hard) way.
7. ATTACK: attack time. It determines the time elapsed from the threshold being exceeded to the compressor coming into operation. The range covers from 0.1 ms. to 500 ms.
8. RELAY: determines the time it takes for the compressor to stop acting once the input signal level falls below the threshold. In this case, the range covers from 10ms. to 1s.
9. MAKE-UP: additional gain applied to the channel signal once it has been compressed, with the aim of recovering the lost decibels for the maximums of the signal, as an effect of the compression applied. The range covers from 0 to 10dB.

18.7. PANIC

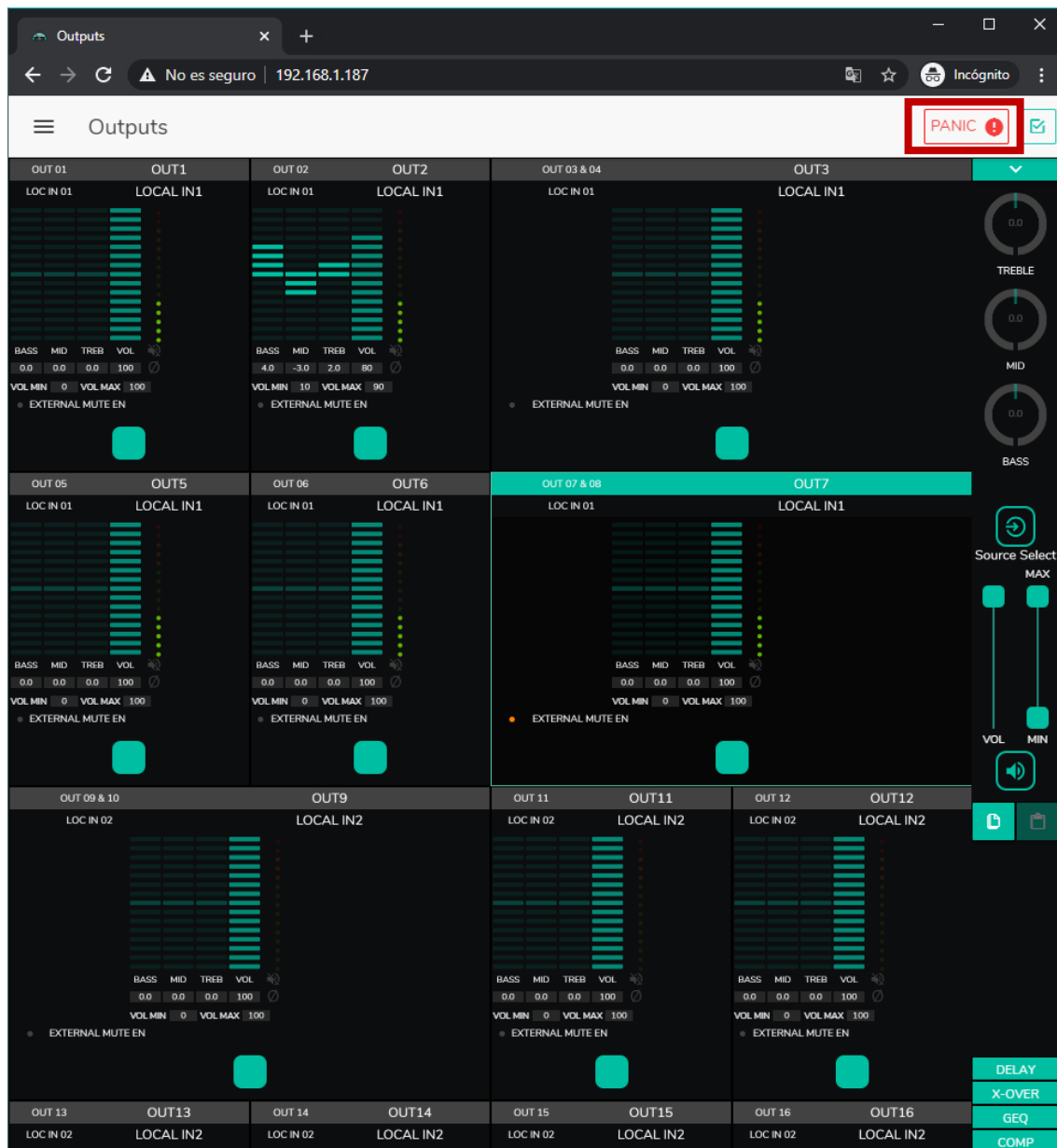



Figure 56: PANIC button on a HUB1616

Finally, the exits have a panic button (PANIC) located in the upper right corner of the OUTPUTS page.

When activated, all the output channels of the HUB device are muted (absolute silence of the system), including the priority modules. Deactivating it restores the MUTES ON or OFF setting prior to activation. The icon  corresponding to each output will flash after activating the PANIC button, if it was not previously muted.

19. GENERAL VOLUME

The general volume is configured in the GENERAL VOLUME page.

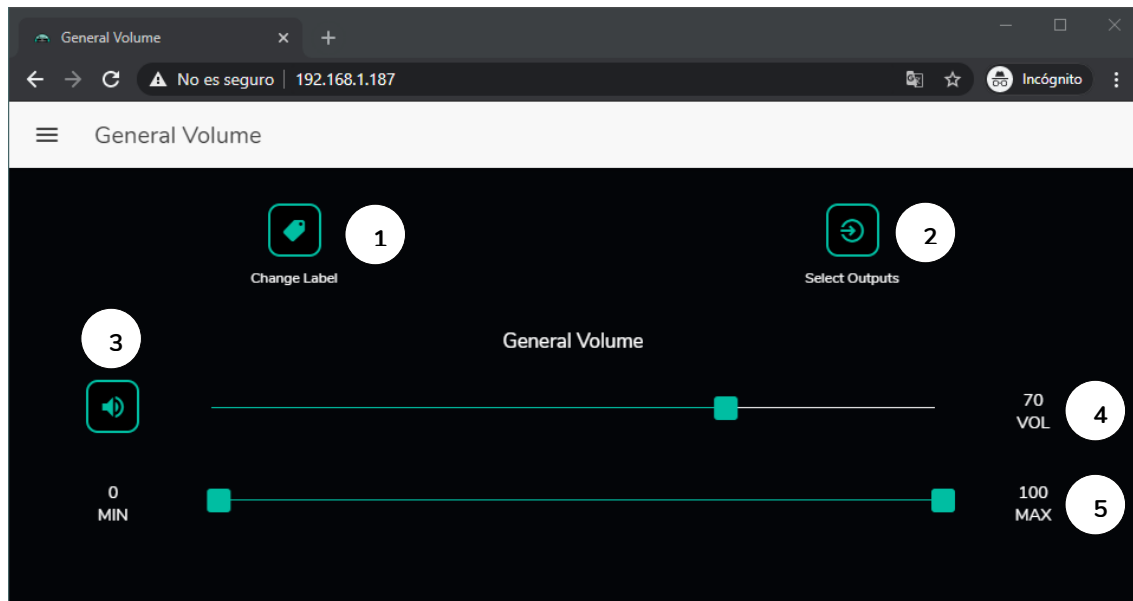

Figure 57: general volume configuration page

The overall volume affects all outputs assigned to this control (by default, all outputs). It is a volume control proportional to the individual volumes of each outlet, so that if the general volume is set to 70, but a certain outlet (OUT1 e.g.) has the volume at 100, the effective volume in the zone will be 70. If another zone has the volume set to 50 (OUT2 e.g.), the volume in that zone will be reduced by 30%, as the overall volume is set to 70. Similarly, if the general volume is set to MUTE or volume 0, all outputs assigned to that volume will be muted.

It can be controlled from the front panel and from the pilot panels.

It has the following configurable options:

1. **CHANGE LABEL:** allows you to modify the name of the general volume control
2. **SELECT OUTPUTS:** allows you to select those outputs that will be affected by the overall volume.
3. **MUTE:** mutes the overall volume. Pressing this button will mute all zones that are affected by the overall volume, and the zone LEDs on the front panel of the device will illuminate.
4. **Adjusting the overall volume.**
5. **Maximum and Minimum Volume:** allows you to define the range between the maximum and minimum volume that can be adjusted using the appropriate volume control.

20. PAGERS/DUCKERS

In the PAGERS/DUCKERS page, up to 4 priority modules can be configured, two of them in DUCKER mode only (automatic priority triggering by audio signal detection), and the other two in PAGER mode (manual management by means of warning console, eMPAGE) or DUCKER.

20.1. DUCKERS

Ducker function (priority): an input can be configured with priority over another/s, being able to attenuate and replace the audio content of certain pre-selected zones, when it exceeds the detection threshold. This function is vital in emergency/evacuation systems, where a certain alarm and/or evacuation message must be played instead of the usual audio program when an emergency scenario is detected.

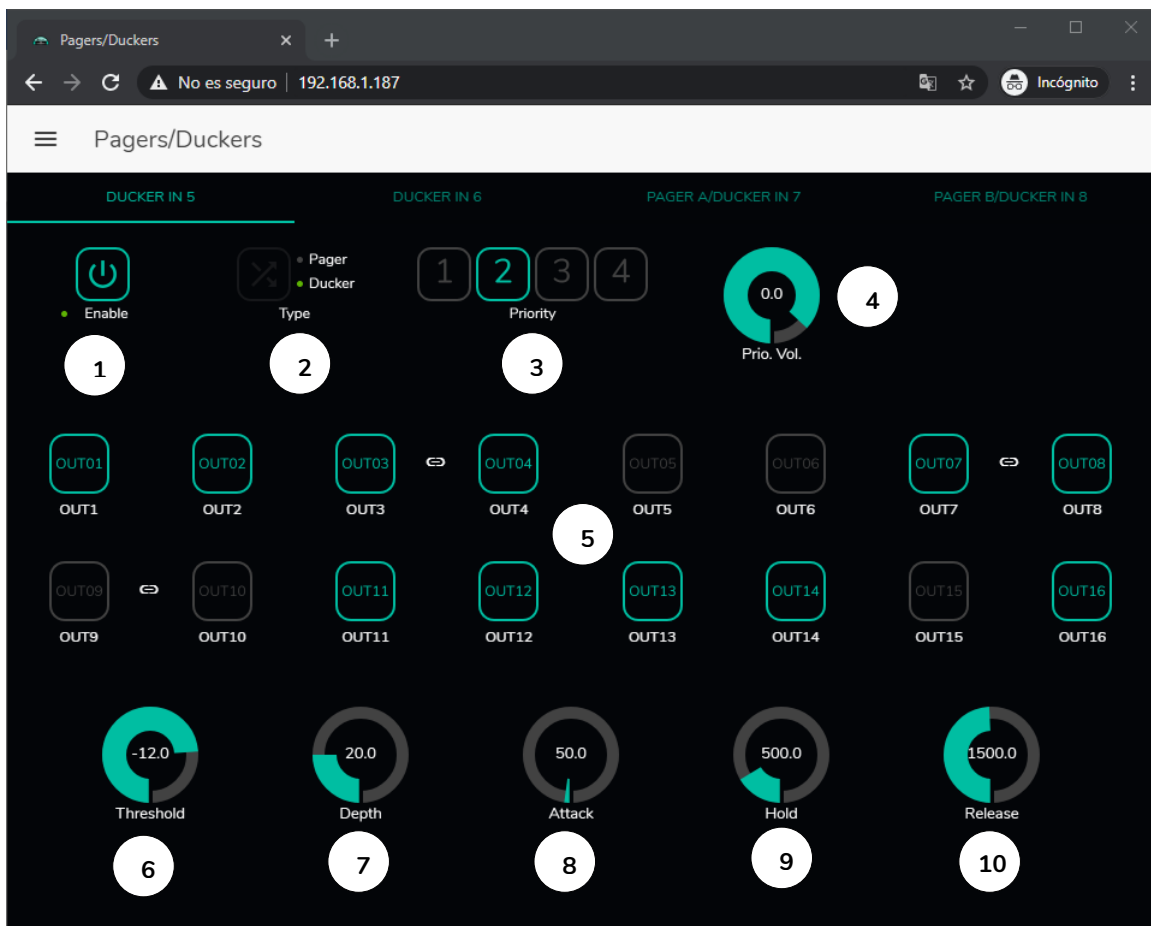

Figure 58:pagers/duckersZZ page

The microphone inputs can be configured to behave like a *ducker*. For each *ducker*, the following parameters can be set:

- **Enable:** Enables or disables the *ducker* function for that input.
- **Pager/Ducker:** only available for the pager inputs, all other microphone inputs have this function disabled. Switches between pager and *ducker* function, indicating with a green LED the selected option.
- **Priority:** There are 4 priority levels, 1 being the maximum priority level and 4 the minimum.
 - A signal with higher priority inhibits the rest, with lower priority, as long as it keeps the priority module active
 - A signal with a higher priority, if it appears when a signal with a lower priority has triggered the priority module, will “eject” it from that module, taking control over it, and as long as it keeps the priority module active
 - If two or more signals with the same priority coincide in time, the first one to exceed the detection threshold will have priority, the others being ignored as long as the first one keeps the module active.
- **Prio. Vol:** volume of the priority module. The priority module volume setting is independent of the zone volume and overall volume, so if any of the zones are muted (MUTE) or very low in volume, priority voice messages are guaranteed to reach that zone at an appropriate volume. It allows a setting that covers from -40dB to +6dB.
- **Zone Pre-Select Buttons:** Allows you to select those zones to which priority messages will be sent.

Ducker parameters adjustment:

- **THRESHOLD:** activation threshold. When the input signal exceeds this threshold, the *ducker* function is activated, sending the signal to the target zones (-80 to 12dB).
- **DEPTH:** attenuation applied to the rest of the signals sent to the target zone(s) during the range in which the *ducker* function is active (0 to 80 dB)
- **ATTACK:** Attack time. It determines the time elapsed from the detection threshold being exceeded until the *ducker* starts working (the attenuation of the rest of the signals in the target zones is activated). The range covers from 5 ms to 2 seconds
- **HOLD:** Holding time, in which the *ducker* function is still active once the signal drops below the detection threshold again. Adjustment range from 10 ms to 3 seconds
- **RELEASE:** determines the time it takes for the attenuation to disappear after the period determined by HOLD. In this case, the range is from 50 ms to 3 seconds.

20.1. PAGERS

On the same PAGERS/DUCKERS page, two priority modules can be configured in PAGER mode, A and B (management by means of the alert console, eMPAGE), assignable to the pager inputs.

Pager function (priority): sending voice warnings in real time to certain destination zones, selected by means of an eMPAGE console.

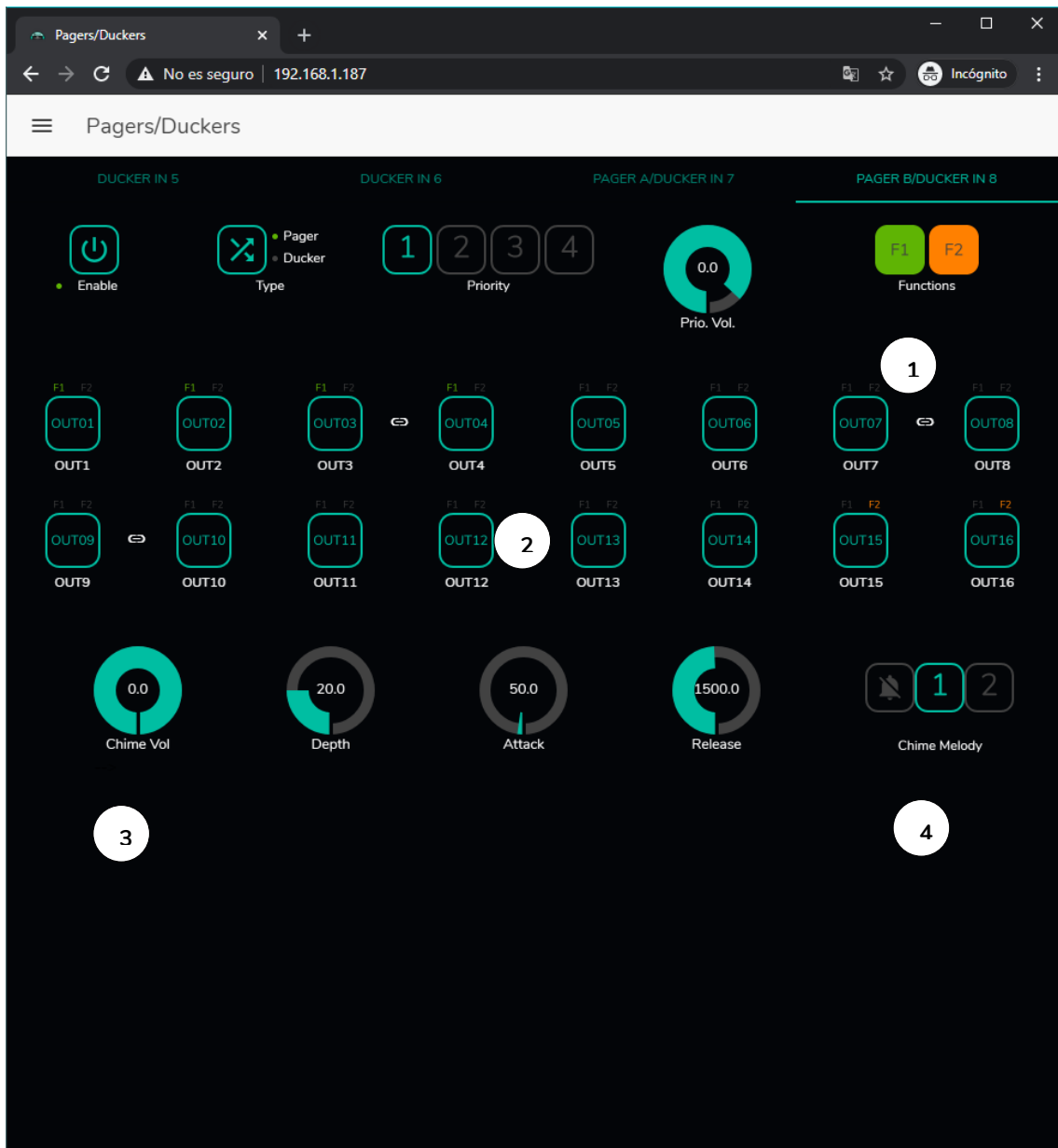

Figure 59: pager configuration page

A pager is configured in the same way as a ducker, with the exception of a few features:

- Special function keys **F1** and **F2**: they allow to group several zones, so that when one of these keys is pressed on the console, all those zones that have been grouped under that key will be selected.

To select the grouped zones by pressing the F1 or F2 key on the console, it is necessary to press on their representation in the web application and select the desired options from the drop-down menu that will appear.

A miniature F1 / F2 icon will appear over each zone indicator, indicating which zones are grouped using these keys. In the Figure 59, the F1 key groups the selection of zones 1, 2 and 3-4 (stereo zone) and the F2 key groups the selection of zones 15 and 16.

- **Zone enable buttons**: allow you to decide which zones a console can select as the destination of its messages. Pressing them enables them (in green) or disables them (in grey) for later selection from the front panel of the console.
- **Chime Vol**: playback volume of the carillon melody (-12 to 0dB). This melody is mixed with the microphone signal of a PAGER (RJ-45) input, its effective volume being affected by the general volume of the input channel.
- **Chime melody selector**: allows you to select two possible chimes (MELODY 1, MELODY 2) or none at all. Every time a console starts sending a message by means of the PAGE key, first the selected melody will be heard in the destination zones, so that the console user can then give way to the voice message.

Note: there is no HOLD setting. The HOLD time for an eMPAGE console corresponds to the time the user holds the PAGE button down

21. REMOTE CONTROL PANELS

The eMCONTROL1 remote control wall panels, connected to the REMOTE ports on the rear panel of the HUB device, are configured on the REMOTE PANELS page, so that they can be either completely disabled or enabled to act as user control for an area of the installation, including some or all of the following functions:

- Sound source selection, from a custom list for each panel that includes some local sources and/or the **remote source itself***
- Volume adjustment (with maximum and minimum operating range) and mute control
- Equalization adjustment, with 3-tone control (BASS-MID-TREBLE)

***Remote source:** Signal entered into a WPa patch panel, adjacent and complementary to an eMCONTROL1 remote control, providing the WPa panel with a mono and balanced (line level) audio signal to the eMCONTROL1 panel. This audio signal will be routed from the eMCONTROL1 panel to the REMOTE port of the HUB unit via a single CAT5 cable or better, together with the necessary control data and DC power. Please refer to the user manual of the WPaMIX-T and eMCONTROL1 devices at www.ecler.com for more information about the connection.



Figure 60: WPaMIX-T in combination with eMCONTROL1

The REMOTE PANELS page shows the status of the 8 panels that can be connected to a HUB unit.

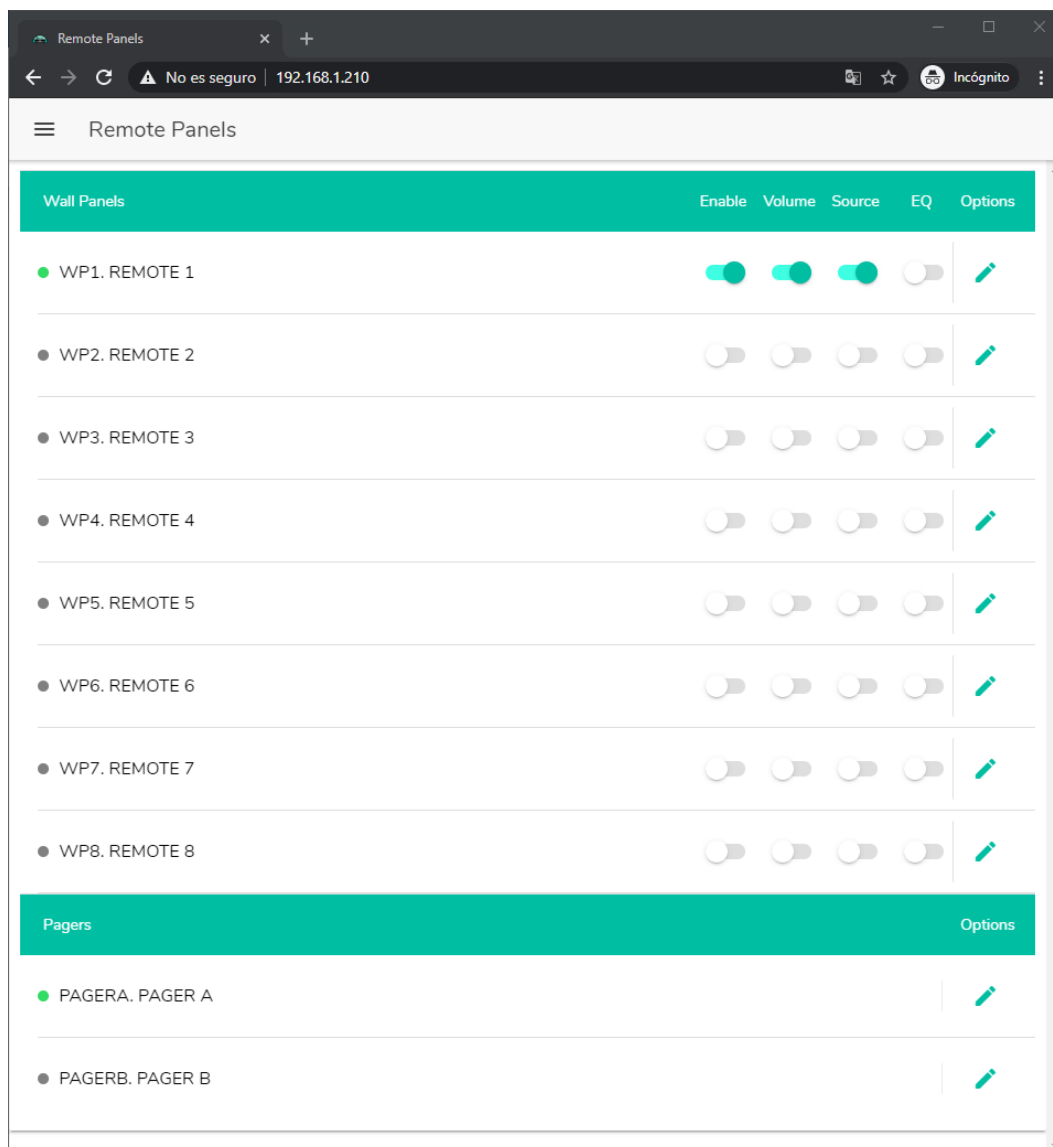

Figure 61: remote control wall panels configuration page

The circular indicator on the left side of the remote panel indicates its status: disconnected (grey) or physically connected (green) to the HUB unit.

The eMCONTROL1 remote controls have the following options:

- **Enable:** enabled or disabled status of the unit
- **Volume:** Volume adjustment function enabled or disabled for the unit
- **Source:** source selection function enabled or disabled for the unit
- **EQ:** equalization adjustment function, tone control, unit enabled or disabled

Clicking on the edit icon under the Options column takes you to the next configuration window.

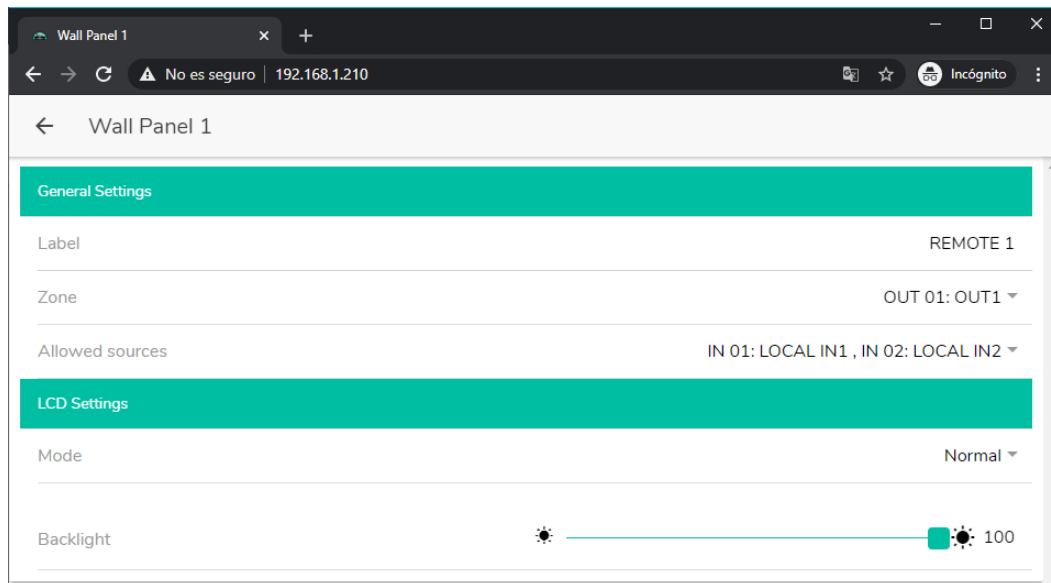

Figure 62: eMCONTROL1 setting parameters

The options available in this window, for each eMCONTROL1 remote control panel, are:

- **Label:** name assigned to the panel. Editable
- **Zone:** zone (output of the HUB unit) under control from the remote panel Selectable from a drop-down menu. One panel can manage only one zone.
- **Allowed sources:** list of music sources (inputs from the HUB unit) that can be selected by the remote panel to be played in the area under your control. Selectable from a drop-down menu. More than one source can be selected.
- **Mode:** behaviour of the remote panel backlighting after a period of 20 seconds with no activity on its physical controls. The options are, selectable from a drop-down menu:
 - Normal: remains unchanged
 - Dimmed: the backlight is dimmed)
 - Off: The backlight is completely turned off.
- **Backlight:** intensity of the remote panel backlighting in use. Sliding adjustment, with values from 0 to 100

On the same page it is possible to display the status of the eMPAGE message consoles connected (or not) to the HUB unit.

The circular indicator on the left of each station indicates its status: disconnected (grey) or physically connected (green) to the HUB unit.

By clicking on the edit icon under the Options column, you can access the station configuration window, where you can edit the name of each station.

22. PILOT PANELS

On the PILOT PANELS page, the administrator configures the control panels that users can operate through external devices by running the **Ecler pilot** application (see chapter [ECLER_PILOT](#) for more information) or standard web browsers, after identifying themselves with their credentials. Up to 32 pilot panels can be created, each with its own configuration.

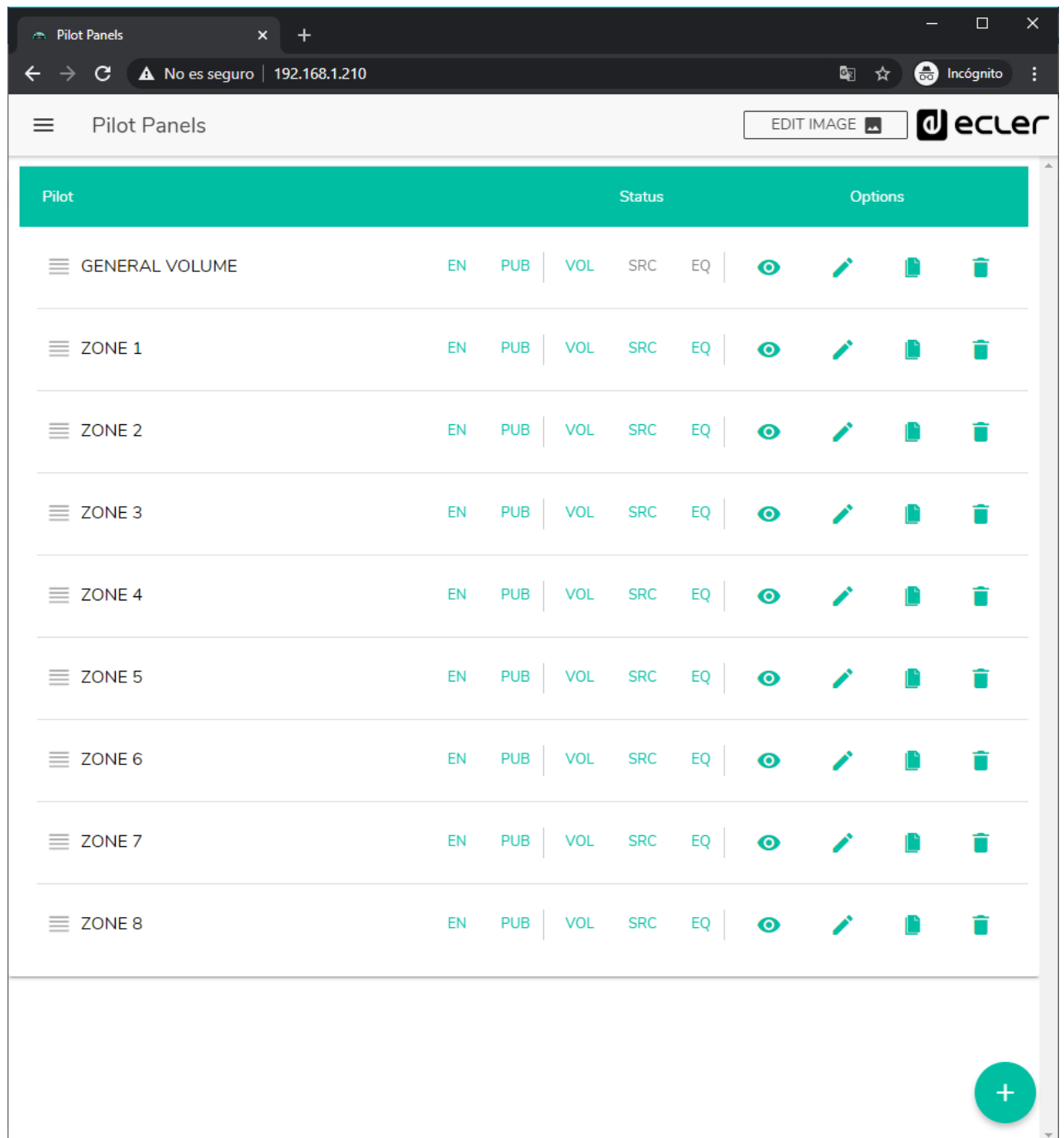

Figure 63: pilot panels configuration page

A *pilot panel* is a set of controls for a zone (or audio output from a HUB device), which can be manipulated by one or more users. The controls that can be accessed on a *pilot panel* are: **volume, source selection and equalization**. Each of these 3 controls can be enabled or disabled within the *pilot panel*.

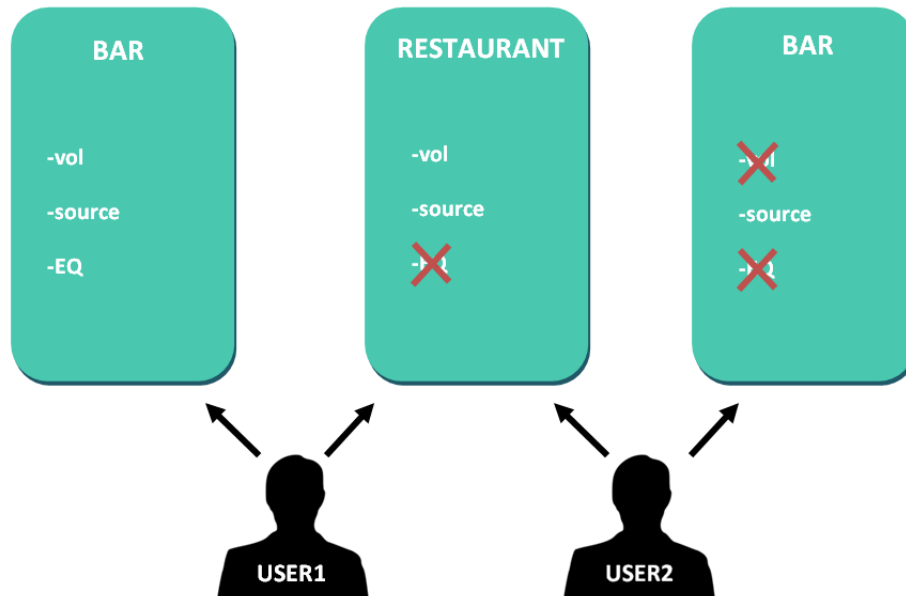

Figure 64: example of pilot panels configuration

In this way, the same user can control different zones (or *pilot panels*), in each of them, he will have control over the functions he is allowed (volume, source selection, EQ). On the other hand, the same zone can be controlled by different users, but with different permissions (two *pilot panels*): in the Figure 64, user 1 has access to all bar controls, however, user 2 can only manipulate the source selection.

Each user displays in his application (web/iOS/Android) only those *pilot panels* to which he has access. Similarly, it only displays the controls it has enabled on those *pilot panels*. You can change the order in which the list of *pilot panels* is displayed by dragging one of them to the desired position while holding down the icon to the left of the name (☰).

Application for Android and iOS, to control available *pilot panels*: **Ecler pilot** (see chapter [ECLER PILOT](#) for more information).

In the PILOT PANELS page is shown a summary of the panels created (see Figure 63). To the right of the *pilot panel* name, the available options are displayed.





22.1. STATUS

Status of the panel options. Displays a summary of the panel settings:

- **EN:** enabled/disabled. A *pilot panel* can be enabled or disabled by accessing the panel editing page.
- **PUB:** if it is green, it indicates that the *pilot panel* belongs to the public profile, i.e. all users have access to the *pilot panel* (no credentials required).
- **VOL:** if it is green, the volume control (and MUTE) is enabled in the *pilot panel*.
- **SRC:** if it is green, the source selection is enabled in the *pilot panel*.
- **EQ:** if it is green, equalisation is enabled on the *pilot panel*.

22.2. OPTIONS

Editing options of a previously created panel. To create a new *pilot panel*, click on the button  in the lower-right corner. On the *pilot panel* configuration page, the following options are available:

- : preview of the *pilot panel*.
- : edit page of the *pilot panel*.
- : duplicates the *pilot panel*.
- : deletes the *pilot panel*.

Clicking on the edit icon accesses the *pilot panel* configuration page. It is also accessible when creating one for the first time.

Once the *pilot panel* is configured, press the SAVE button to save and apply the changes. Press the CANCEL button to cancel any modification in the panel.

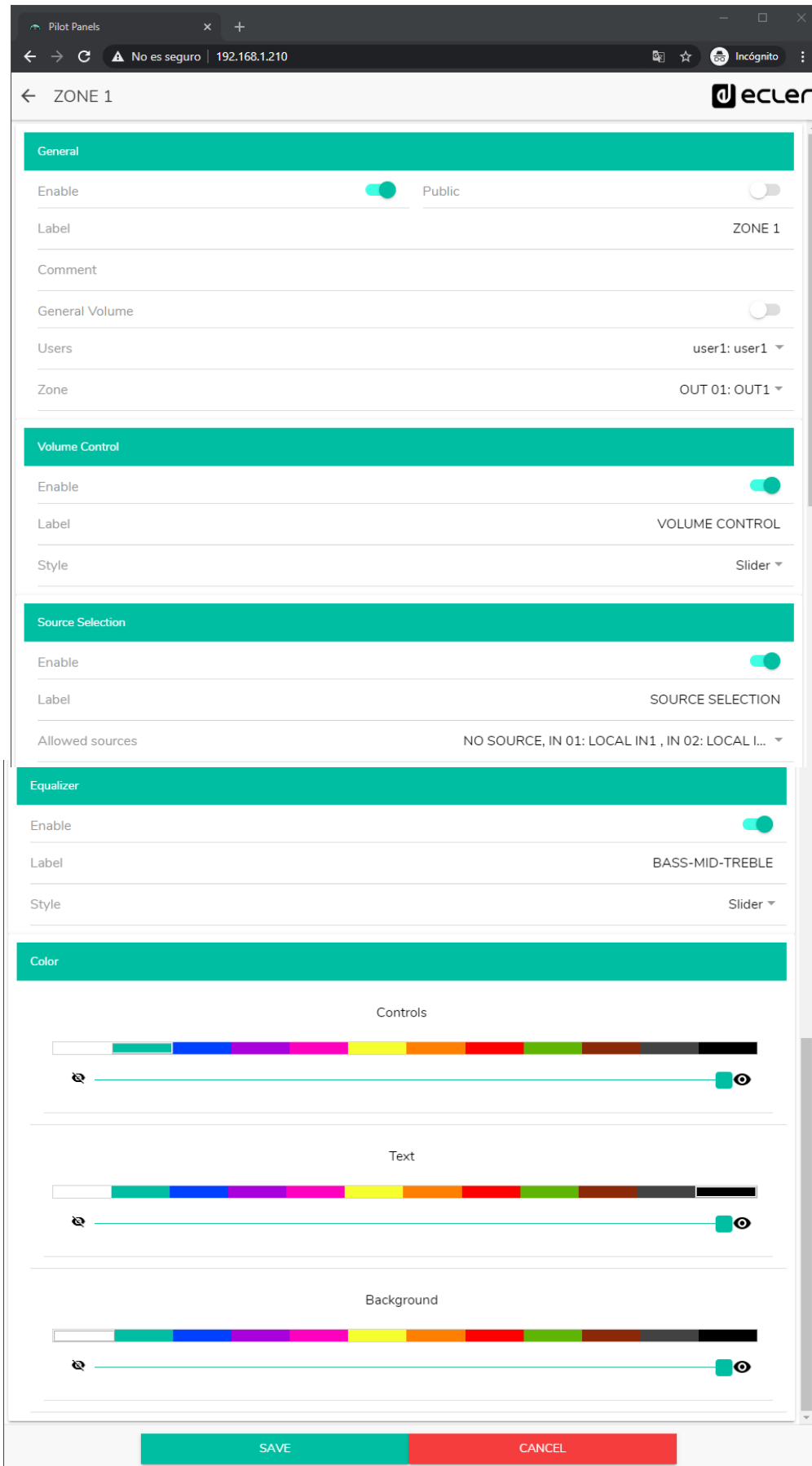

ZONE 1

General

- Enable: Public
- Label: ZONE 1
- Comment:
- General Volume:
- Users: user1: user1
- Zone: OUT 01: OUT1

Volume Control

- Enable:
- Label: VOLUME CONTROL
- Style: Slider

Source Selection

- Enable:
- Label: SOURCE SELECTION
- Allowed sources: NO SOURCE, IN 01: LOCAL IN1, IN 02: LOCAL I...

Equalizer

- Enable:
- Label: BASS-MID-TREBLE
- Style: Slider

Color

Controls

Text

Background

SAVE CANCEL

Figure 65: Pilot panel configuration page

22.3. GENERAL

- **Enable:** enable/disable *pilot panel*.
- **Public:** determines if the panel belongs to the public profile or not. If it belongs to the public profile, any user has access to the *pilot panels* of this profile (no login credentials required). If selected, the user selection option (*Users*) will be disabled.
- **Label:** you can give this pilot panel a name, for example, the name of the area under control.
- **Comment:** allows you to add a comment.
- **General Volume:** you can create *pilot panels* of the general volume. If you select this option, the zone selection, source selection and equalization options will be disabled.
- **Users:** selection of users with access to the *pilot panel*. You can select one, several or all users.
- **Zone:** zone (audio output) under control.

22.4. VOLUME CONTROL

- **Enable:** Enable/disable the volume control for the selected zone.
- **Label:** you can name this volume control, which will be displayed in the control panel
- **Style:** you can select type of control for the volume.

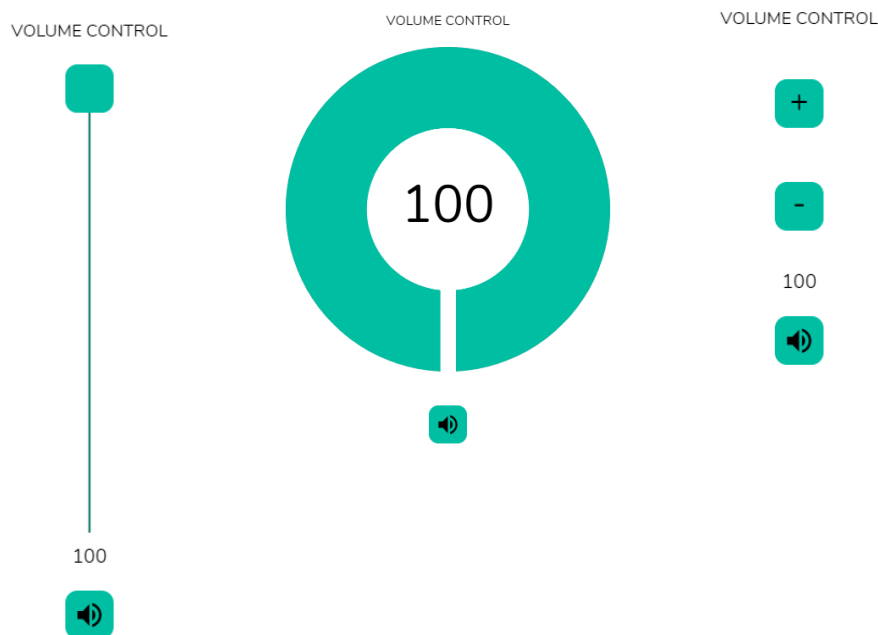

Figure 66: different types of volume control

22.5. SOURCE SELECTION

- **Enable:** enable/disable source selection for the selected zone.
- **Label:** you can name the source selection control, which will be displayed on the control panel.
- **Allowed sources:** allowed sources. Select the audio sources that will be available for selection in that zone. You can limit the number of sources available in a zone, or leave all of them accessible. The application will automatically draw the zone selection control.

Note: The end user can only select one source from the list above at a time.

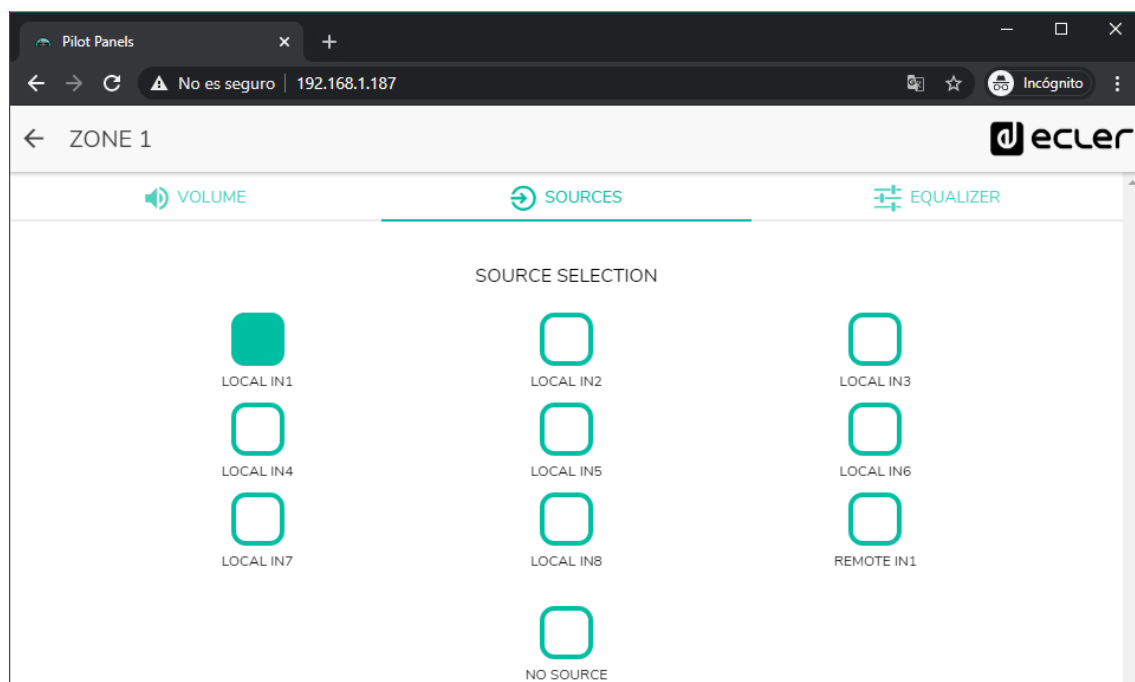

Figure 67: selecting sources from a pilot panel

22.6. EQUALIZER

- **Enable:** Enable/disable the EQ for the selected zone.
- **Label:** you can give a name to this equalization control, which will be displayed in the control panel.
- **Style:** you can select the type of control the EQ will have.

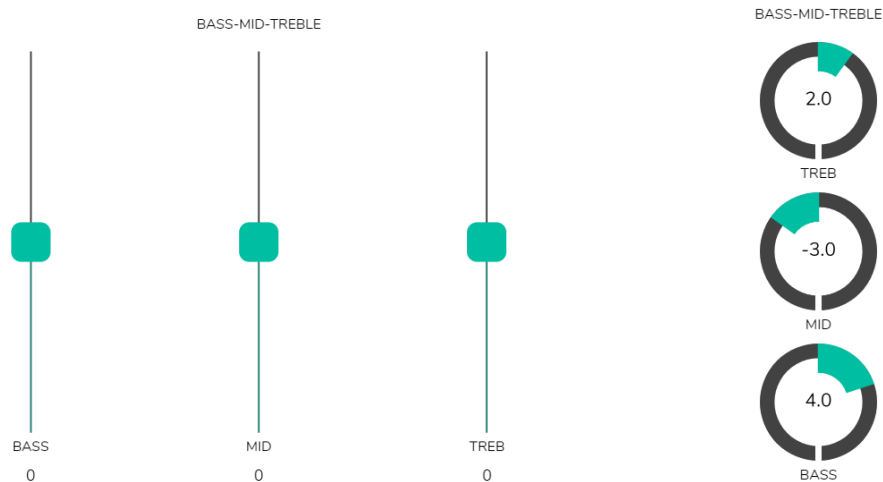

Figure 68: different types of tone control

22.7. COLOR

You can customize the user controls in terms of colors. Throughout the color range, you can adjust the transparency to achieve other shades.

- **Controls:** main colour of the controls.
- **Text:** Text colour.
- **Background:** Background colour.

Below are some examples of *pilot panels*.

22.8. IMAGE

The *pilot panels* can be customized by adding a small image or a corporate logo in the upper right corner of the panel. This image or logo will be the same for all users including the public profile.

To do this, click on the EDIT IMAGE button in the upper right corner to open the image editing dialog.

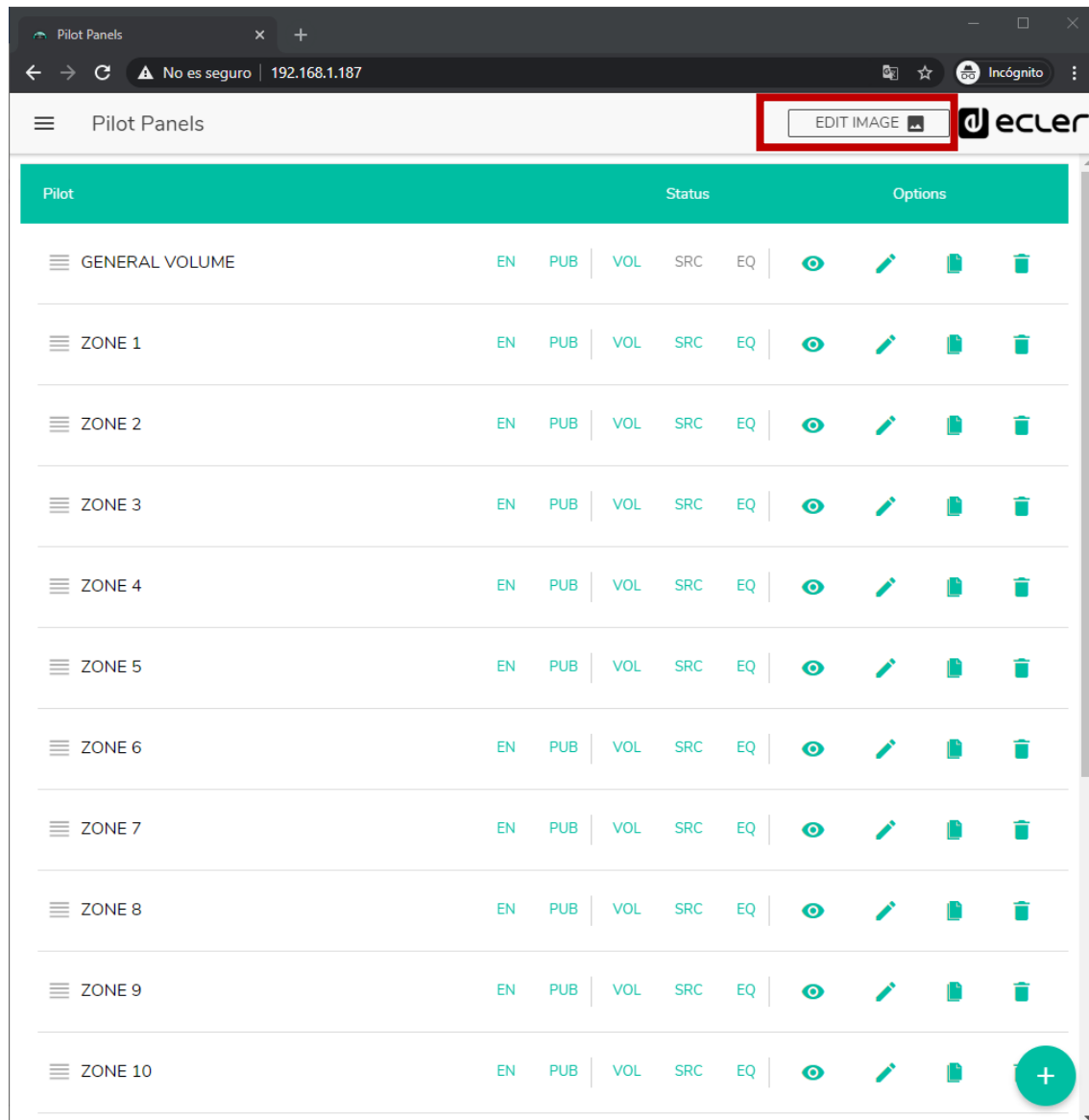

Figure 69: edit image button

To modify the image, once the dialog box is open, click on the “add” button (green “+” sign) in the upper right corner. Your file browser will open. Select the desired image and adjust the mask to it. The selected image cannot exceed 50KB. Press the save button to apply the changes.

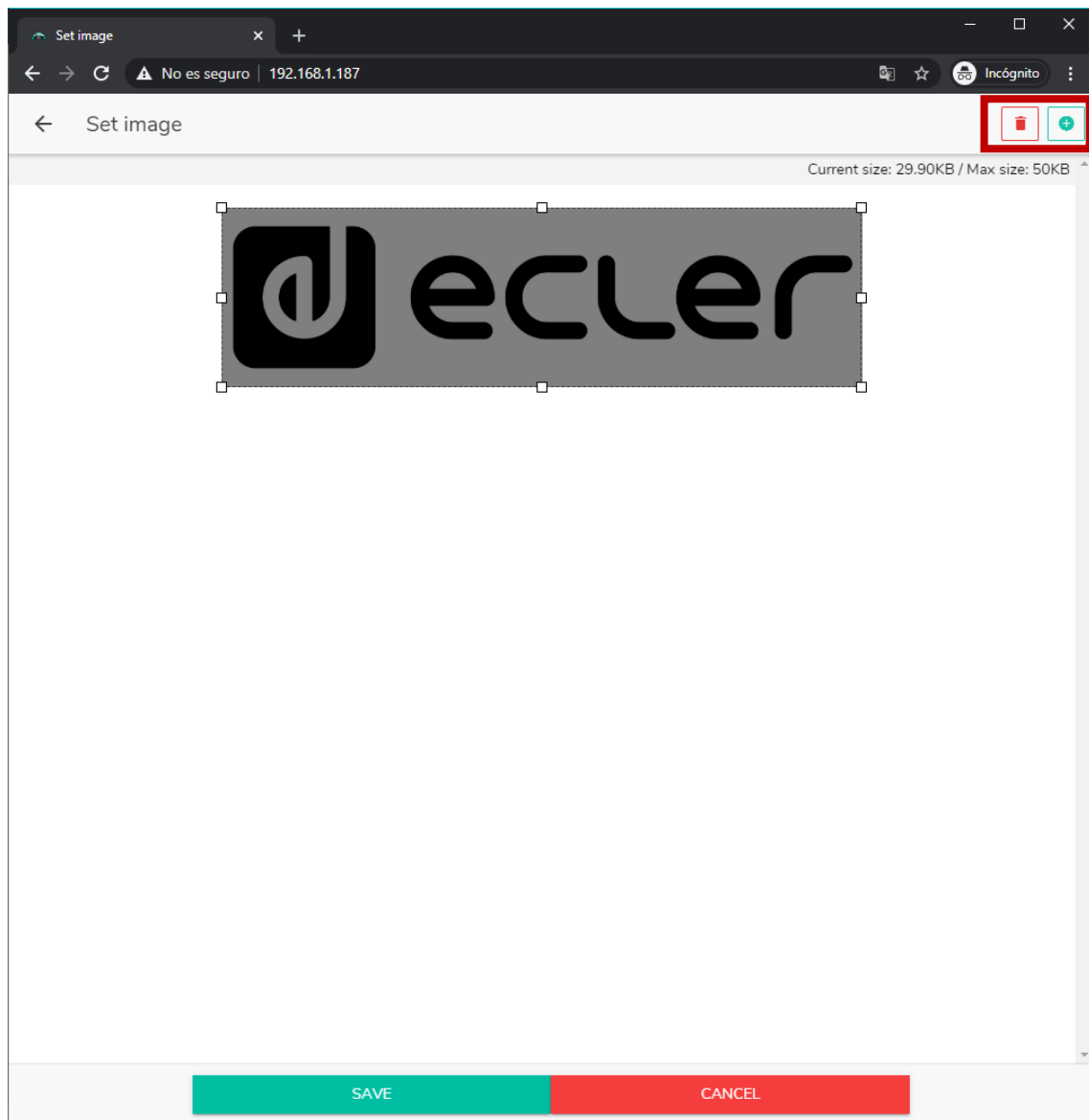

Figure 70: editing an image or logo

If you want to delete the image or logo (nothing will be displayed), click on the button represented by a trash can in the upper right corner.

22.9. PILOT PANELS EXAMPLES

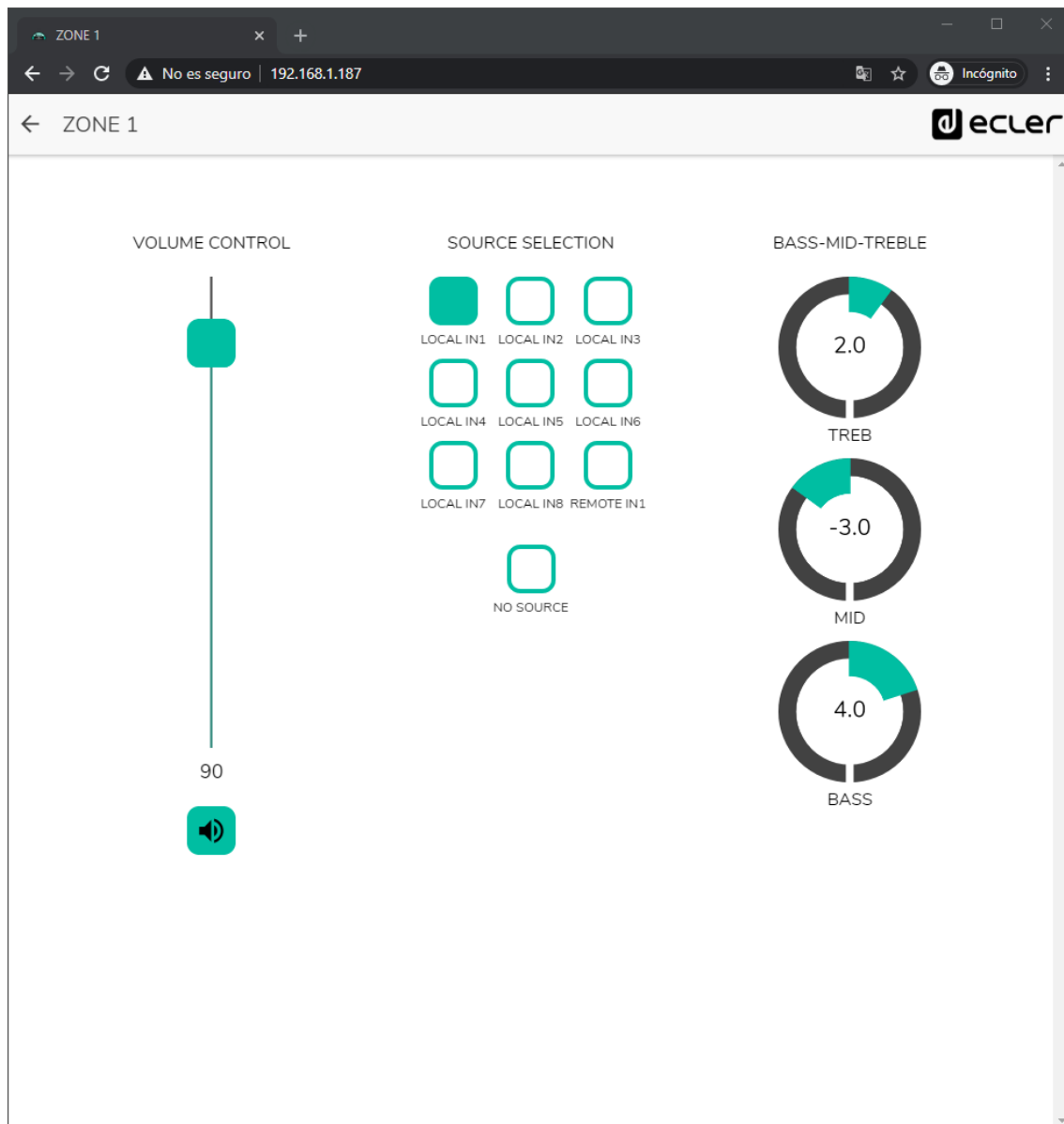

Figure 71: pilot panel with volume control, source selector and tone control

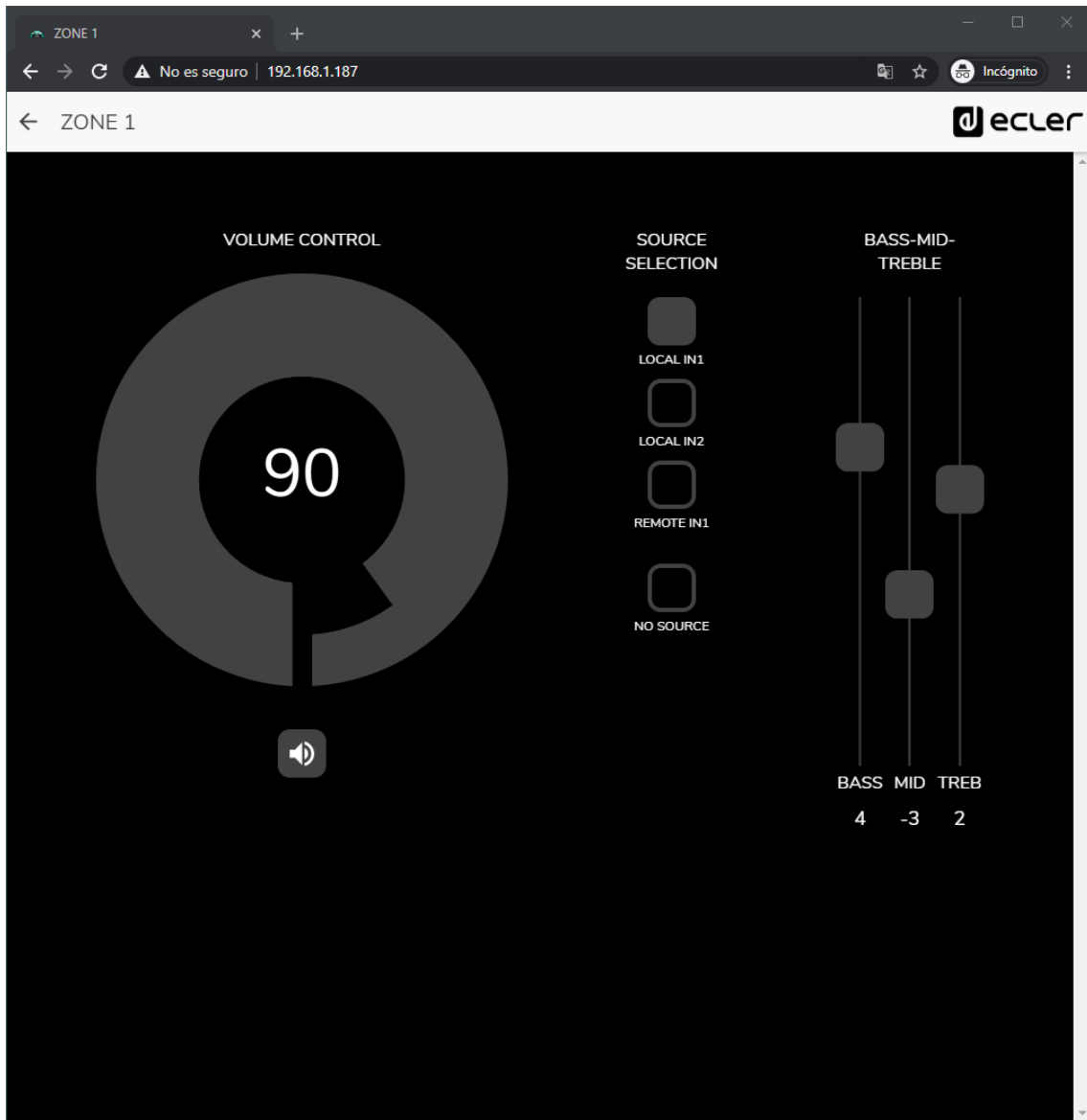

Figure 72: same pilot panel with different sources available and different color palette

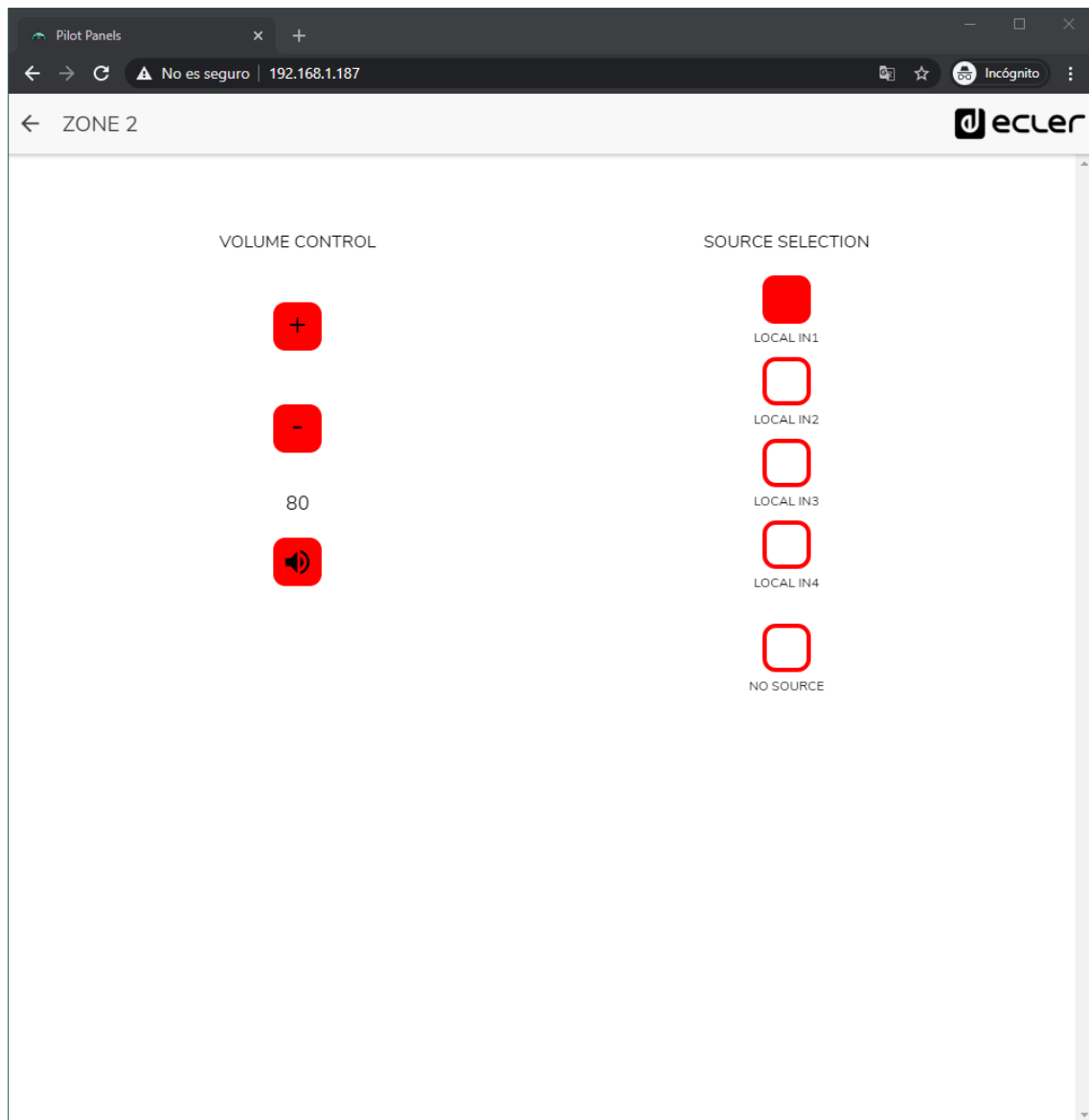

Figure 73: pilot panel with volume control and source selector

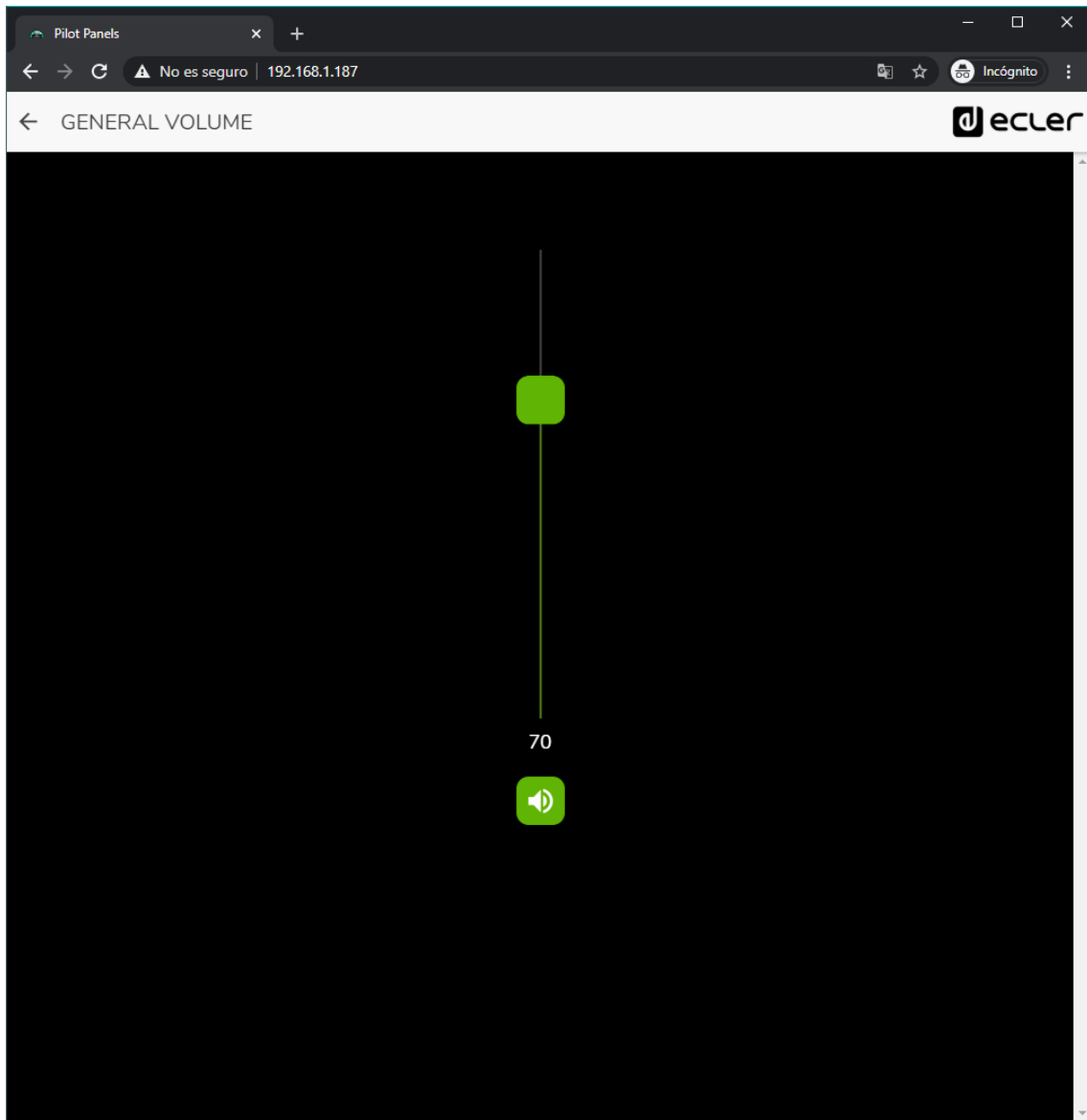

Figure 74: pilot panel of the general volume control

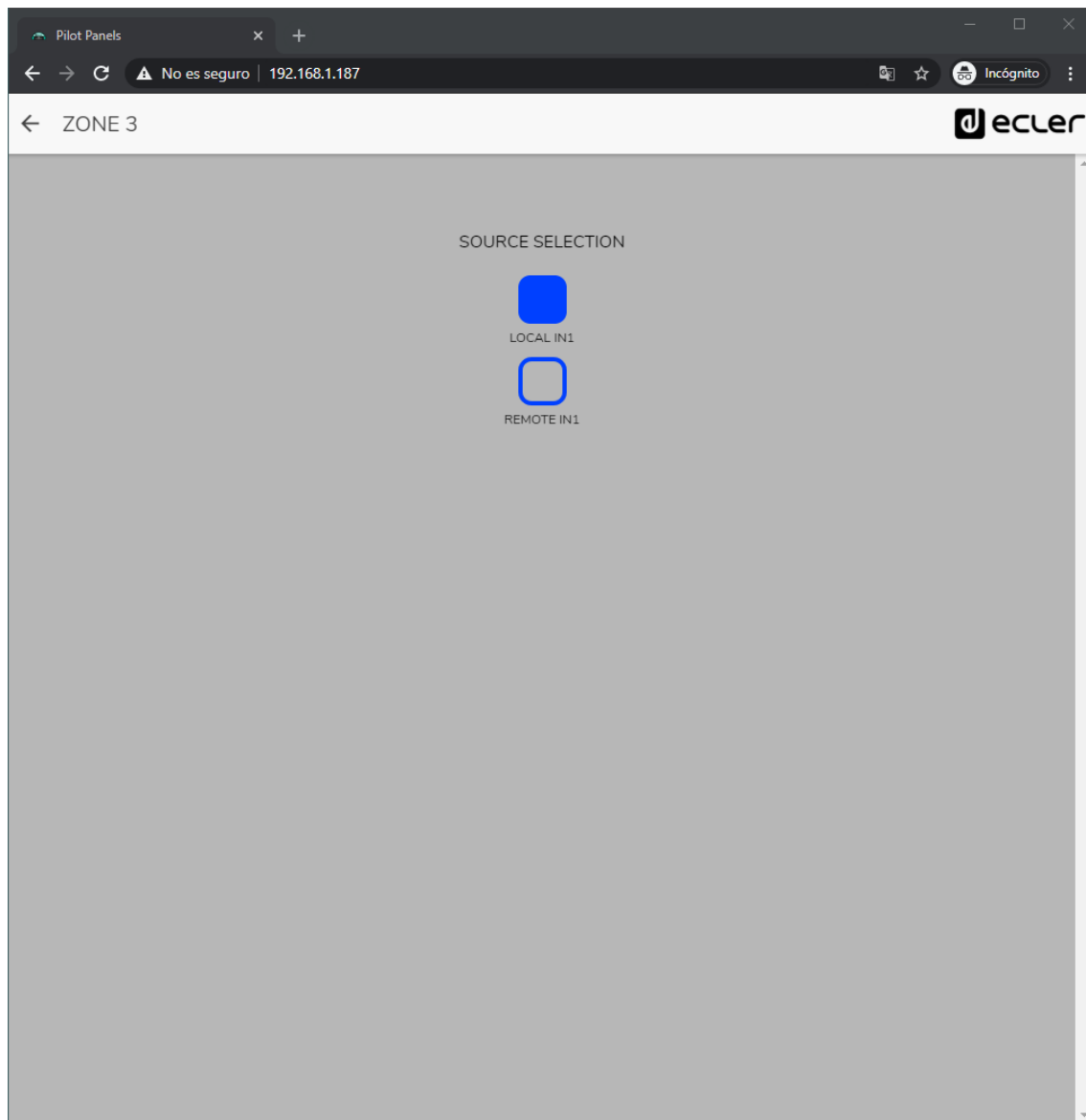

Figure 75: pilot panel with just local source selection (HUB) and remote (eMCONTROL + WPaMIX-T)

23. HELP

The help page contains useful information about the HUB device and is easily accessible. This information is only accessible when the device is connected to the Internet.

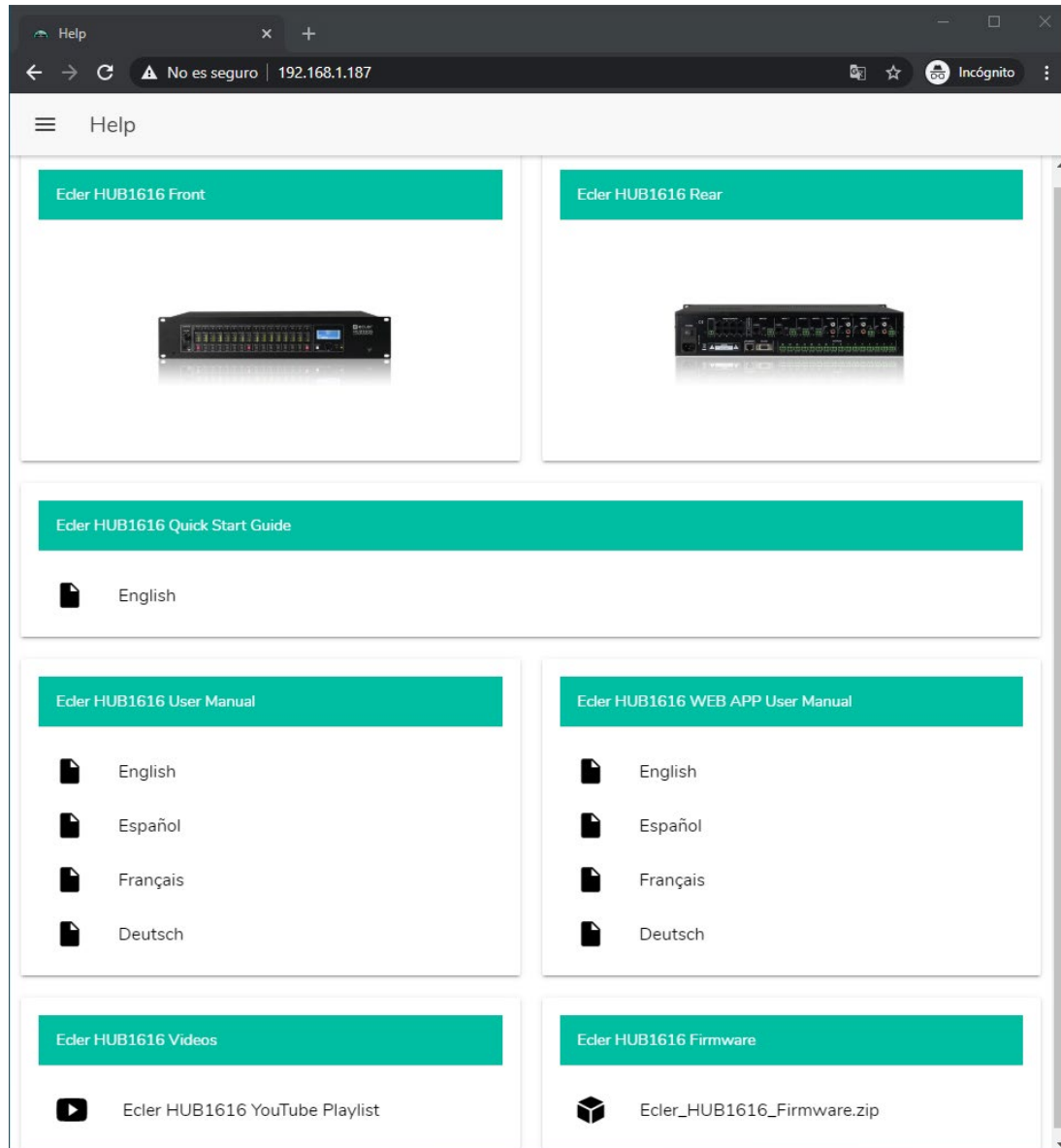

Figure 76: help/information page

- **Front and back panel:** links to high-resolution images of the device's front and back panels
- **Quick Start Guide:** link to the quick start guide for the device.
- **Manuals:** links to the manuals for the HUB device and the HANGAR web application itself
- **Videos:** links to device-related videos, such as installation and start-up video tutorials
- **Firmware:** link to the latest firmware version of the device.

24. ACCESS TO PUBLIC PILOT PANELS

A user can control his *pilot panels* from his smart device, by pre-installing the Ecler pilot application available in Google Store and Apple Store (see chapter [ECLER PILOT](#)). However, it is also possible to access these *pilot panels* from any web browser, using the HANGAR web application. In the latter case, simply open your browser and type the IP in the navigation bar of the HUB unit you want to control.

To access the public profile, click on the PUBLIC PILOT PANELS button. No login credentials are required. The *pilot panels*, created by the administrator, available in the public profile will be displayed.

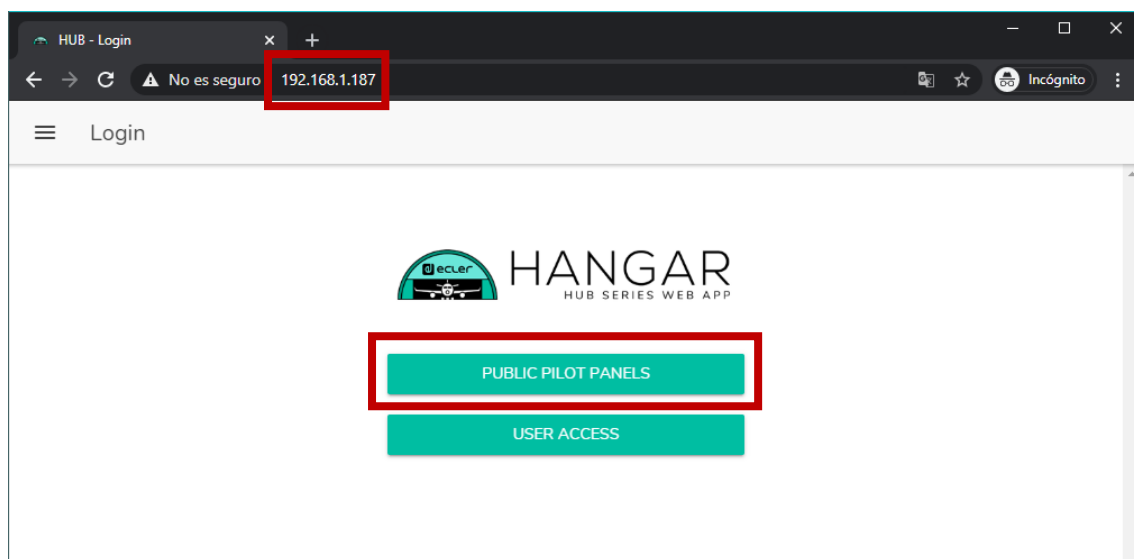

Figure 77: access to the public profile

Note: the client device (computer, Tablet, Smartphone, etc.) that runs the Ecler pilot application (or a web browser) to access the *pilot panels*, must be connected to the same local network as the HUB unit it is targeting, and that acts as a server for the *pilot panels*, in the same IP range as this one.

25. ACCESS TO THE WEB APP AS A USER

To access the panels assigned to a User from the HANGAR web application, open your browser, type the IP in the navigation bar of the HUB unit you want to control, enter your credentials for access (they must be provided by the administrator) and press the access button (SIGN IN).

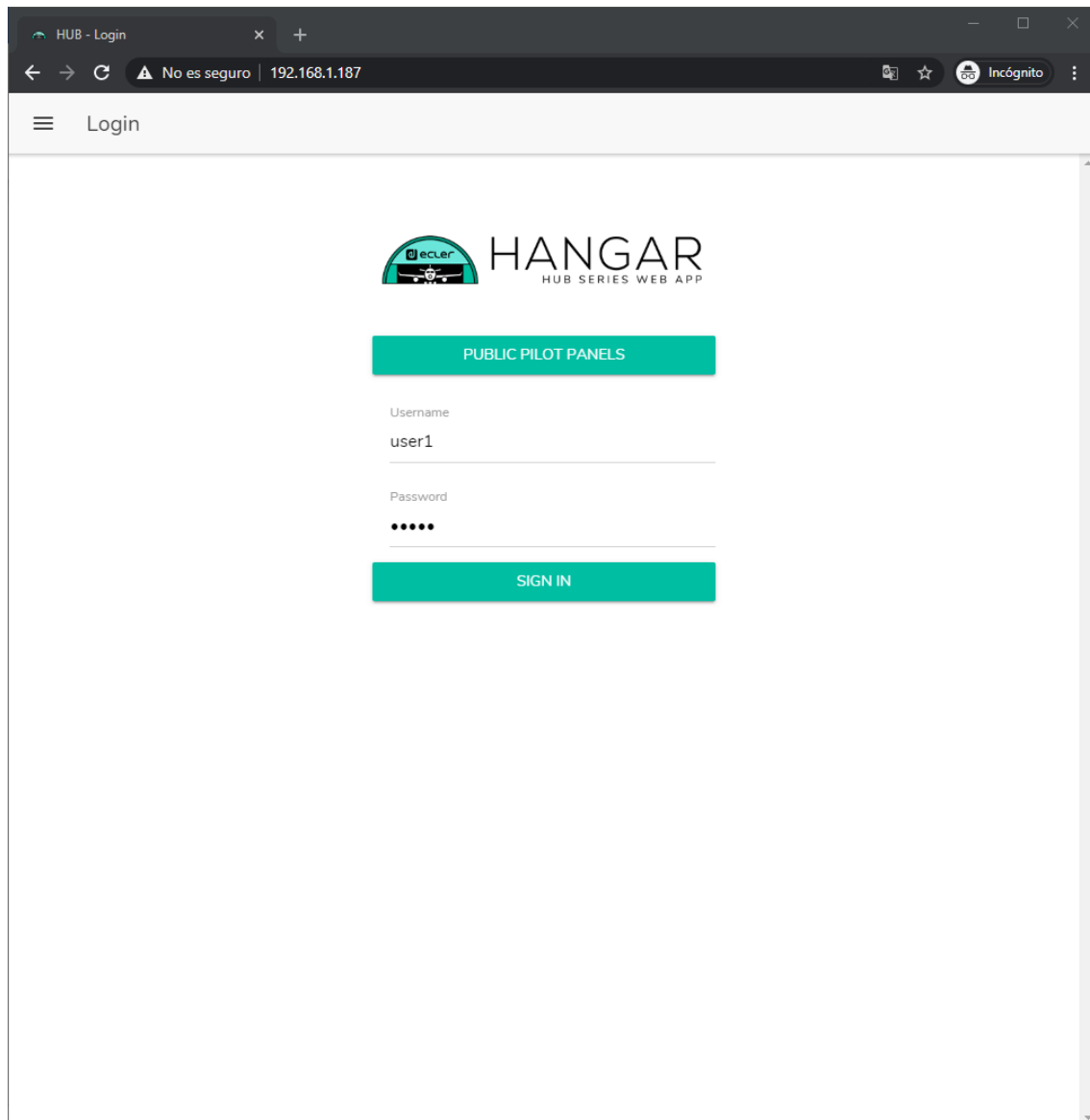

Figure 78: user access

You will then see a list of the panels assigned to that user.

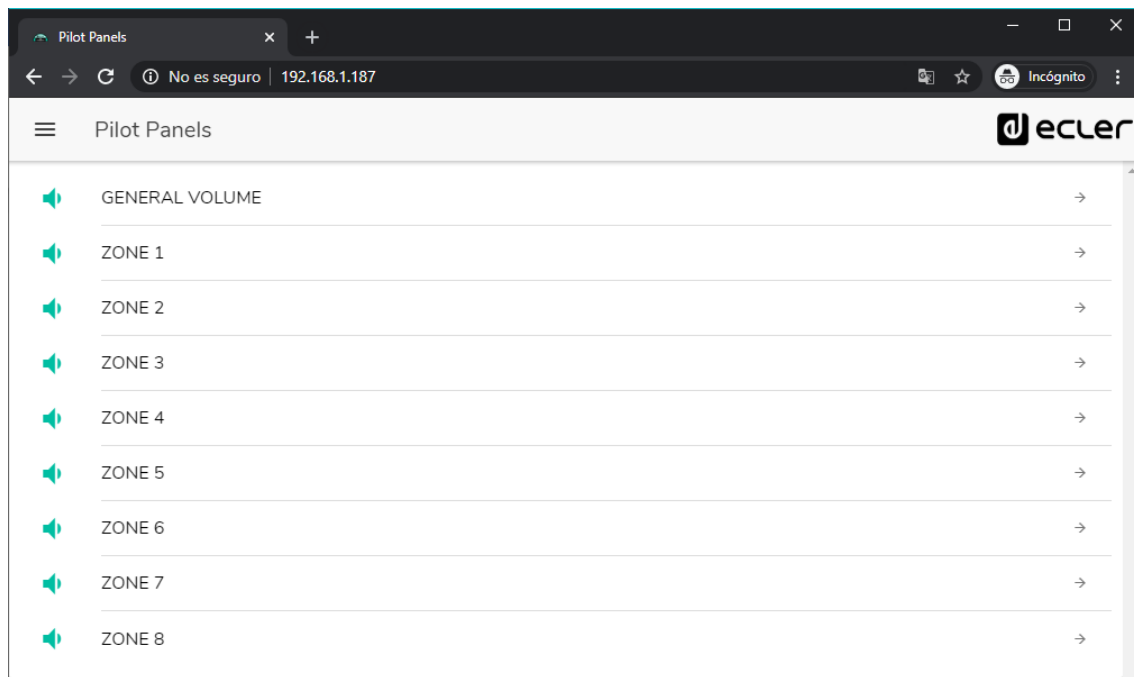

Figure 79: pilot panels assigned to a user

You can start flying your HUB device now!

26. ECLER PILOT

Ecler pilot is an application for remote control by the end user over one or more zones of an installation managed by a HUB device. It is available for iOS and Android. The application can be downloaded for free from the shops:



1. Ecler pilot logo for iOS

Before opening the application, make sure that the HUB and the control device (Smartphone, Tablet, etc.) are on the same local network. This network must have a WiFi access point to connect the Smartphone or Tablet.

Note: The Ecler pilot application replaces the eMIMO pilot application. The new Ecler pilot application is also compatible with Ecler eMIMO1616 devices. No eMIMO1616 device firmware update is required to use the application with eMIMO1616 devices.

26.1. ADDING A DEVICE

Open the application. If you open it for the first time, you will need to link a HUB device to control. To do this, press the “DISCOVER DEVICES” button to search for available HUB devices in your local network.

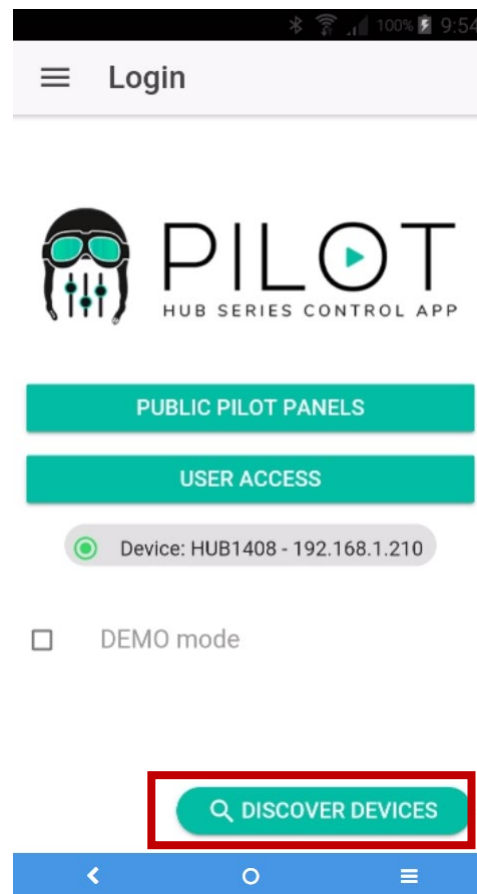

Figure 80: Ecler pilot application login page

A list of available devices (name and IP address) is then displayed. A green LED on the left side of the device indicates that the device is connected and ready to use. If the LED is grey, it is a device that was previously linked but is not currently available on the same network as the mobile device. Drag the list down to update it.

Tap on the device you want to connect to. The application will remember the devices you have previously connected to. So once linked, when you access it again from the application, it will not need to be linked again, and will automatically connect to the last device you accessed.

You can delete unavailable devices by clicking on the icon represented by a trash can.

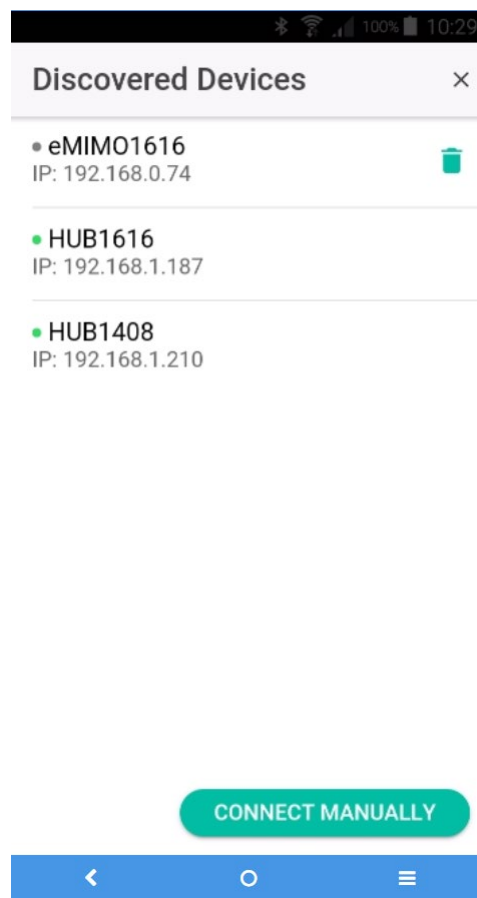

Figure 81: list of automatically discovered devices

If the device is not listed, a **manual connection** may be required. Use the following procedure:

1. Press the CONNECT MANUALLY button.
2. Check the IP address of the HUB device. You can do this by accessing the configuration screen (CONFIG) on the front panel by pressing and holding the CTRL and encoder keys simultaneously for 3 seconds.
3. Enter the IP address of the device in the application.

If connection problems persist, check the network settings.

Pressing the device to which you want to connect will take you back to the main page, where the connection status with the HUB unit is indicated.

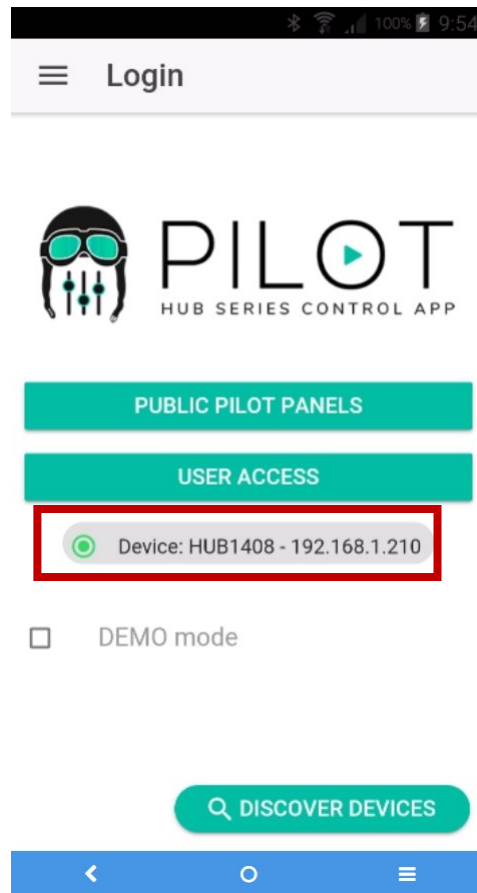

Figure 82: HUB device connection status

A green LED next to the device indicates that it is connected. If the LED is grey, it means it is not connected. The device name and IP address are also indicated.

26.2. ACCESSING THE CONTROL PANELS

Each user accesses the control panels assigned to them by clicking on the USER ACCESS button with their account credentials. The privileges of this account are previously configured by the HUB unit Administrator.

To access the public profile, click on the PUBLIC PILOT PANELS button. No credentials are required.

The user can then start piloting his HUB. The user will see the *pilot panels* assigned to him by the HUB administrator.

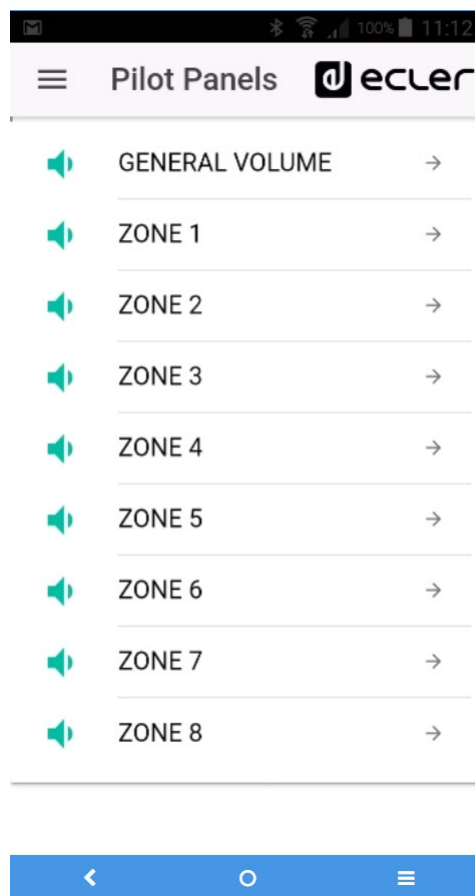

Figure 83: list of pilot panels configured for a user

By clicking on any *pilot panel* in the list, you can modify those controls to which you have access.

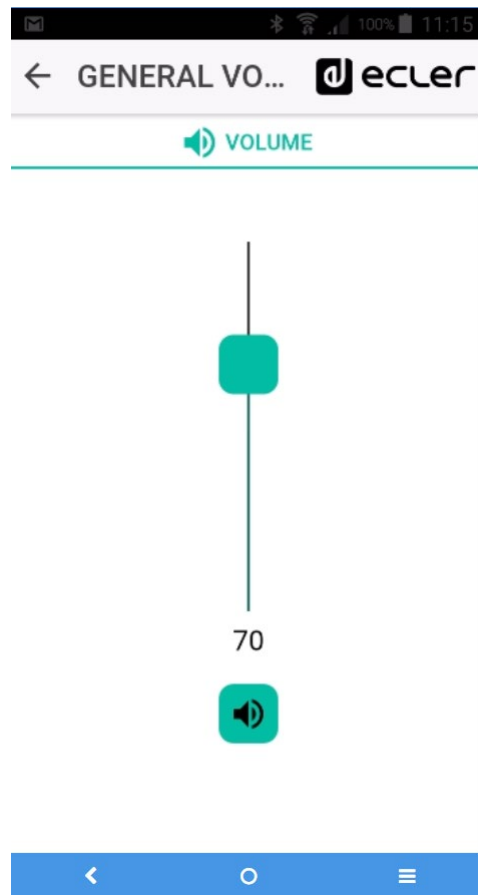

Figure 84: general volume control assigned to a given user

26.3. LOADING DEFAULT SETTINGS

By displaying the menu (button ≡ in the upper left corner), a drop-down menu opens where you can select the Predefined setups sub-menu, provided that the administrator has enabled this option for the public profile.

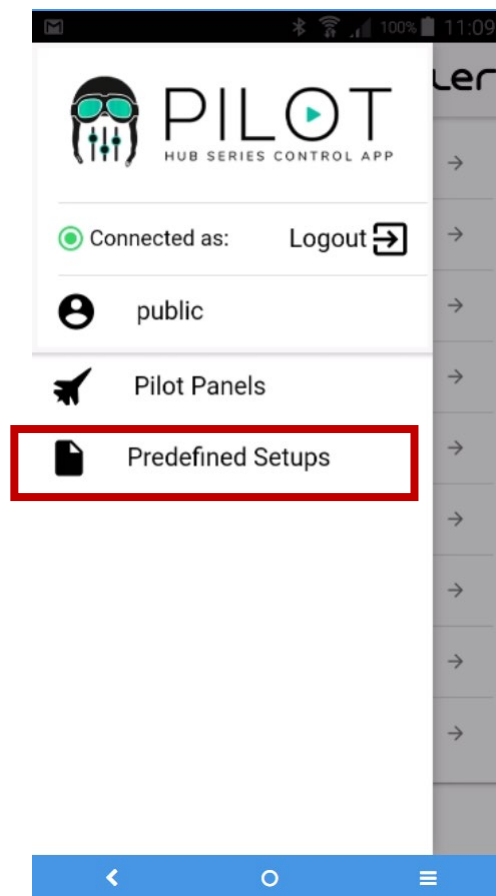

Figure 85: Predefined setups menu

Clicking on *Predefined setups* will display the list of available configurations. Clicking on one of them will load it into the device, overwriting the current configuration, and it will be restarted.

See chapter [APPENDIX](#) to learn more about these default settings.

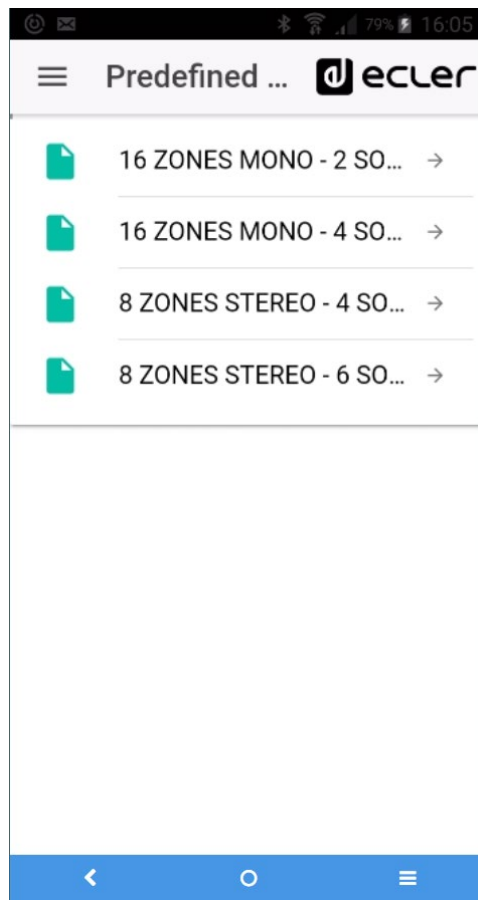

Figure 86: list of default settings for a user

26.4. DEMO MODE

If you do not yet have a HUB device, you can start your pilot training using the demonstration mode. Simply select the “DEMO mode” option on the home page, choose the HUB device you wish to pilot and enter a username (any), or access the public profile. No connection to a HUB device is required in this mode. eMIMO1616 demo mode is also available.

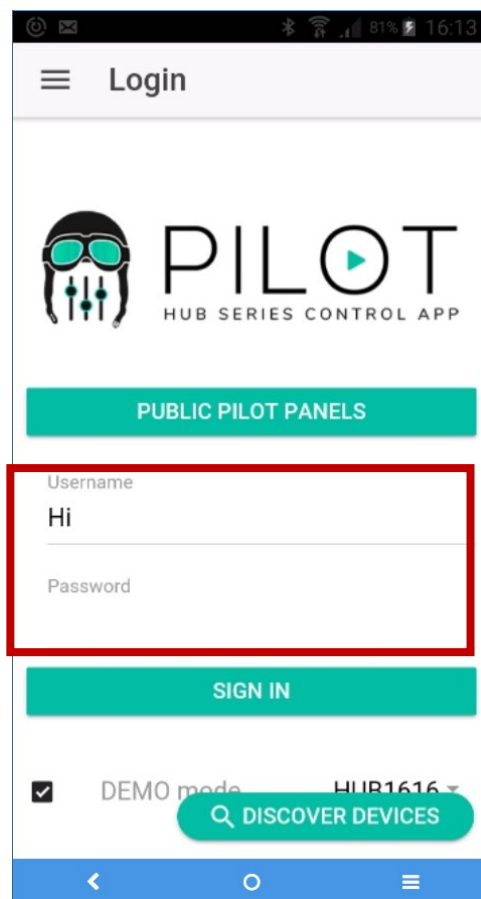

Figure 87: demo mode does not require credentials, just enter any user name

27. APPENDIX

27.1. PREDEFINED SETUPS HUB1616

General parameters:

- Network: DHCP mode
- Name: HUB1616
- Boot-up mode: remember status.
- Public profile: allow loading predefined setups.
- Users: no users
- DSP: all disabled.
- General Volume: pilot panel. Vol = 70%
- Pagers / duckers: disabled.
- Remote panels: no remote panels

27.1.1. Factory setup / 16 ZONES MONO – 2 SOURCES

PRESELECTED INPUT	OUTPUT	PILOT PANELS			
		ZONE	SOURCE	VOL	EQ
INPUT 1	OUTPUT 1	ZONE 1	OFF / 1 / 2	✓	✓
INPUT 1	OUTPUT 2	ZONE 2	OFF / 1 / 2	✓	✓
INPUT 1	OUTPUT 3	ZONE 3	OFF / 1 / 2	✓	✓
INPUT 1	OUTPUT 4	ZONE 4	OFF / 1 / 2	✓	✓
INPUT 1	OUTPUT 5	ZONE 5	OFF / 1 / 2	✓	✓
INPUT 1	OUTPUT 6	ZONE 6	OFF / 1 / 2	✓	✓
INPUT 1	OUTPUT 7	ZONE 7	OFF / 1 / 2	✓	✓
INPUT 1	OUTPUT 8	ZONE 8	OFF / 1 / 2	✓	✓
INPUT 2	OUTPUT 9	ZONE 9	OFF / 1 / 2	✓	✓
INPUT 2	OUTPUT 10	ZONE 10	OFF / 1 / 2	✓	✓
INPUT 2	OUTPUT 11	ZONE 11	OFF / 1 / 2	✓	✓
INPUT 2	OUTPUT 12	ZONE 12	OFF / 1 / 2	✓	✓
INPUT 2	OUTPUT 13	ZONE 13	OFF / 1 / 2	✓	✓
INPUT 2	OUTPUT 14	ZONE 14	OFF / 1 / 2	✓	✓
INPUT 2	OUTPUT 15	ZONE 15	OFF / 1 / 2	✓	✓
INPUT 2	OUTPUT 16	ZONE 16	OFF / 1 / 2	✓	✓
PAGERS / DUCKERS	PRESELECTED OUTPUTS	CONFIGURATION	PRIORITY		
INPUT 5	ALL OUTPUTS	LINE MONO	4		
INPUT 6	ALL OUTPUTS	LINE MONO	3		
INPUT 7	ALL OUTPUTS	LINE MONO	2		
INPUT 8	ALL OUTPUTS	MICRO	1		

27.1.2. 16 ZONES MONO – 4 SOURCES

PRESELECTED INPUT	OUTPUT	PILOT PANELS			
		ZONE	SOURCE	VOL	EQ
INPUT 1	OUTPUT 1	ZONE 1	OFF / 1 / 2 / 3 / 4	✓	✓
INPUT 1	OUTPUT 2	ZONE 2	OFF / 1 / 2 / 3 / 4	✓	✓
INPUT 1	OUTPUT 3	ZONE 3	OFF / 1 / 2 / 3 / 4	✓	✓
INPUT 1	OUTPUT 4	ZONE 4	OFF / 1 / 2 / 3 / 4	✓	✓
INPUT 1	OUTPUT 5	ZONE 5	OFF / 1 / 2 / 3 / 4	✓	✓
INPUT 1	OUTPUT 6	ZONE 6	OFF / 1 / 2 / 3 / 4	✓	✓
INPUT 1	OUTPUT 7	ZONE 7	OFF / 1 / 2 / 3 / 4	✓	✓
INPUT 1	OUTPUT 8	ZONE 8	OFF / 1 / 2 / 3 / 4	✓	✓
INPUT 1	OUTPUT 9	ZONE 9	OFF / 1 / 2 / 3 / 4	✓	✓
INPUT 1	OUTPUT 10	ZONE 10	OFF / 1 / 2 / 3 / 4	✓	✓
INPUT 1	OUTPUT 11	ZONE 11	OFF / 1 / 2 / 3 / 4	✓	✓
INPUT 1	OUTPUT 12	ZONE 12	OFF / 1 / 2 / 3 / 4	✓	✓
INPUT 1	OUTPUT 13	ZONE 13	OFF / 1 / 2 / 3 / 4	✓	✓
INPUT 1	OUTPUT 14	ZONE 14	OFF / 1 / 2 / 3 / 4	✓	✓
INPUT 1	OUTPUT 15	ZONE 15	OFF / 1 / 2 / 3 / 4	✓	✓
INPUT 1	OUTPUT 16	ZONE 16	OFF / 1 / 2 / 3 / 4	✓	✓
PAGERS / DUCKERS	PRESELECTED OUTPUTS	CONFIGURATION	PRIORITY		
INPUT 5	ALL OUTPUTS	LINE MONO	4		
INPUT 6	ALL OUTPUTS	LINE MONO	3		
INPUT 7	ALL OUTPUTS	LINE MONO	2		
INPUT 8	ALL OUTPUTS	MICRO	1		

27.1.3. 8 ZONES STEREO – 4 SOURCES

PRESELECTED INPUT	OUTPUT	PILOT PANELS			
		ZONE	SOURCE	VOL	EQ
INPUT 1	OUTPUT 1 (L)	ZONE 1 (ST)	OFF / 1 / 2 / 3 / 4	✓	✓
	OUTPUT 2 (R)				
INPUT 1	OUTPUT 3 (L)	ZONE 2 (ST)	OFF / 1 / 2 / 3 / 4	✓	✓
	OUTPUT 4 (R)				
INPUT 2	OUTPUT 5 (L)	ZONE 3 (ST)	OFF / 1 / 2 / 3 / 4	✓	✓
	OUTPUT 6 (R)				
INPUT 2	OUTPUT 7 (L)	ZONE 4 (ST)	OFF / 1 / 2 / 3 / 4	✓	✓
	OUTPUT 8 (R)				
INPUT 3	OUTPUT 9 (L)	ZONE 5 (ST)	OFF / 1 / 2 / 3 / 4	✓	✓
	OUTPUT 10 (R)				
INPUT 3	OUTPUT 11 (L)	ZONE 6 (ST)	OFF / 1 / 2 / 3 / 4	✓	✓
	OUTPUT 12 (R)				
INPUT 4	OUTPUT 13 (L)	ZONE 7 (ST)	OFF / 1 / 2 / 3 / 4	✓	✓
	OUTPUT 14 (R)				
INPUT 4	OUTPUT 15 (L)	ZONE 8 (ST)	OFF / 1 / 2 / 3 / 4	✓	✓
	OUTPUT 16 (R)				
PAGERS / DUCKERS	PRESELECTED OUTPUTS	CONFIGURATION	PRIORITY		
INPUT 5	ALL OUTPUTS	LINE MONO	4		
INPUT 6	ALL OUTPUTS	LINE MONO	3		
INPUT 7	ALL OUTPUTS	LINE MONO	2		
INPUT 8	ALL OUTPUTS	MICRO	1		

27.1.4. 8 ZONES STEREO – 6 SOURCES

PRESELECTED INPUT	OUTPUT	PILOT PANELS			
		ZONE	SOURCE	VOL	EQ
INPUT 1	OUTPUT 1 (L)	ZONE 1 (ST)	OFF / 1 / 2 / 3 / 4 / 5-6 (ST) / 7-8 (ST)	✓	✓
	OUTPUT 2 (R)				
INPUT 1	OUTPUT 3 (L)	ZONE 2 (ST)	OFF / 1 / 2 / 3 / 4 / 5-6 (ST) / 7-8 (ST)	✓	✓
	OUTPUT 4 (R)				
INPUT 1	OUTPUT 5 (L)	ZONE 3 (ST)	OFF / 1 / 2 / 3 / 4 / 5-6 (ST) / 7-8 (ST)	✓	✓
	OUTPUT 6 (R)				
INPUT 1	OUTPUT 7 (L)	ZONE 4 (ST)	OFF / 1 / 2 / 3 / 4 / 5-6 (ST) / 7-8 (ST)	✓	✓
	OUTPUT 8 (R)				
INPUT 1	OUTPUT 9 (L)	ZONE 5 (ST)	OFF / 1 / 2 / 3 / 4 / 5-6 (ST) / 7-8 (ST)	✓	✓
	OUTPUT 10 (R)				
INPUT 1	OUTPUT 11 (L)	ZONE 6 (ST)	OFF / 1 / 2 / 3 / 4 / 5-6 (ST) / 7-8 (ST)	✓	✓
	OUTPUT 12 (R)				
INPUT 1	OUTPUT 13 (L)	ZONE 7 (ST)	OFF / 1 / 2 / 3 / 4 / 5-6 (ST) / 7-8 (ST)	✓	✓
	OUTPUT 14 (R)				
INPUT 1	OUTPUT 15 (L)	ZONE 8 (ST)	OFF / 1 / 2 / 3 / 4 / 5-6 (ST) / 7-8 (ST)	✓	✓
	OUTPUT 16 (R)				
PAGERS / DUCKERS	PRESELECTED OUTPUTS	CONFIGURATION	PRIORITY		
INPUT 5 (L)	ALL OUTPUTS	LINE STEREO	2		
INPUT 6 (R)	ALL OUTPUTS				
INPUT 7 (L)	ALL OUTPUTS	LINE STEREO	1		
INPUT 8 (R)	ALL OUTPUTS				

27.2. PREDEFINED SETUPS HUB1408

General parameters:

- Network: DHCP mode
- Name: HUB1408
- Boot-up mode: remember status.
- Public profile: allow loading predefined setups.
- Users: no users
- DSP: all disabled.
- General Volume: pilot panel. Vol = 70%
- Pagers / duckers: disabled.
- Remote panels: no remote panels

27.2.1. Factory setup / 8 ZONES MONO – 2 SOURCES

PRESELECTED INPUT	OUTPUT	PILOT PANELS			
		ZONE	SOURCE	VOL	EQ
INPUT 1	OUTPUT 1	ZONE 1	OFF / 1 / 2	✓	✓
INPUT 1	OUTPUT 2	ZONE 2	OFF / 1 / 2	✓	✓
INPUT 1	OUTPUT 3	ZONE 3	OFF / 1 / 2	✓	✓
INPUT 1	OUTPUT 4	ZONE 4	OFF / 1 / 2	✓	✓
INPUT 2	OUTPUT 5	ZONE 5	OFF / 1 / 2	✓	✓
INPUT 2	OUTPUT 6	ZONE 6	OFF / 1 / 2	✓	✓
INPUT 2	OUTPUT 7	ZONE 7	OFF / 1 / 2	✓	✓
INPUT 2	OUTPUT 8	ZONE 8	OFF / 1 / 2	✓	✓
PAGERS / DUCKERS	PRESELECTED OUTPUTS	CONFIGURATION	PRIORITY		
INPUT 3 (L)	ALL OUTPUTS	LINE STEREO	3		
INPUT 4 (R)	ALL OUTPUTS				
INPUT 5	ALL OUTPUTS	LINE MONO	2		
INPUT 6	ALL OUTPUTS	MICRO	1		

27.2.2. 8 ZONES MONO – 3 SOURCES

PRESELECTED INPUT	OUTPUT	PILOT PANELS			
		ZONE	SOURCE	VOL	EQ
INPUT 1	OUTPUT 1	ZONE 1	OFF / 1 / 2 / 3	✓	✓
INPUT 1	OUTPUT 2	ZONE 2	OFF / 1 / 2 / 3	✓	✓
INPUT 1	OUTPUT 3	ZONE 3	OFF / 1 / 2 / 3	✓	✓
INPUT 1	OUTPUT 4	ZONE 4	OFF / 1 / 2 / 3	✓	✓
INPUT 1	OUTPUT 5	ZONE 5	OFF / 1 / 2 / 3	✓	✓
INPUT 1	OUTPUT 6	ZONE 6	OFF / 1 / 2 / 3	✓	✓
INPUT 1	OUTPUT 7	ZONE 7	OFF / 1 / 2 / 3	✓	✓
INPUT 1	OUTPUT 8	ZONE 8	OFF / 1 / 2 / 3	✓	✓
PAGERS / DUCKERS	PRESELECTED OUTPUTS	CONFIGURATION	PRIORITY		
INPUT 3 (L)	ALL OUTPUTS	LINE STEREO	3		
INPUT 4 (R)	ALL OUTPUTS				
INPUT 5	ALL OUTPUTS	LINE MONO	2		
INPUT 6	ALL OUTPUTS	MICRO	1		

27.2.3. 8 ZONES MONO – 4 SOURCES

PRESELECTED INPUT	OUTPUT	PILOT PANELS			
		ZONE	SOURCE	VOL	EQ
INPUT 1	OUTPUT 1	ZONE 1	OFF / 1 / 2 / 3 / 4	✓	✓
INPUT 1	OUTPUT 2	ZONE 2	OFF / 1 / 2 / 3 / 4	✓	✓
INPUT 1	OUTPUT 3	ZONE 3	OFF / 1 / 2 / 3 / 4	✓	✓
INPUT 1	OUTPUT 4	ZONE 4	OFF / 1 / 2 / 3 / 4	✓	✓
INPUT 2	OUTPUT 5	ZONE 5	OFF / 1 / 2 / 3 / 4	✓	✓
INPUT 2	OUTPUT 6	ZONE 6	OFF / 1 / 2 / 3 / 4	✓	✓
INPUT 3	OUTPUT 7	ZONE 7	OFF / 1 / 2 / 3 / 4	✓	✓
INPUT 4	OUTPUT 8	ZONE 8	OFF / 1 / 2 / 3 / 4	✓	✓
PAGERS / DUCKERS	PRESELECTED OUTPUTS	CONFIGURATION	PRIORITY		
INPUT 3	ALL OUTPUTS	LINE MONO	4		
INPUT 4	ALL OUTPUTS	LINE MONO	3		
INPUT 5	ALL OUTPUTS	LINE MONO	2		
INPUT 6	ALL OUTPUTS	MICRO	1		

27.2.4. 4 ZONES STEREO – 3 SOURCES

PRESELECTED INPUT	OUTPUT	PILOT PANELS			
		ZONE	SOURCE	VOL	EQ
INPUT 1	OUTPUT 1 (L)	ZONE 1 (ST)	OFF / 1 / 2 / 3-4 (ST)	✓	✓
	OUTPUT 2 (R)			✓	✓
INPUT 1	OUTPUT 3 (L)	ZONE 2 (ST)	OFF / 1 / 2 / 3-4 (ST)	✓	✓
	OUTPUT 4 (R)			✓	✓
INPUT 2	OUTPUT 5 (L)	ZONE 3 (ST)	OFF / 1 / 2 / 3-4 (ST)	✓	✓
	OUTPUT 6 (R)			✓	✓
INPUT 3 (L)	OUTPUT 7 (L)	ZONE 4 (ST)	OFF / 1 / 2 / 3-4 (ST)	✓	✓
INPUT 4 (R)	OUTPUT 8 (R)			✓	✓
PAGERS / DUCKERS	PRESELECTED OUTPUTS	CONFIGURATION	PRIORITY		
INPUT 3 (L)	ALL OUTPUTS	LINE STEREO	3		
INPUT 4 (R)	ALL OUTPUTS				
INPUT 5	ALL OUTPUTS	LINE MONO	2		
INPUT 6	ALL OUTPUTS	MICRO	1		

27.3. RESTORE DEFAULTS

General parameters:

- Network: DHCP mode
- Name: HUB1616 / HUB1408 (depending on model)
- Boot-up mode: remember status.
- Public profile: allow loading predefined setups.
- Users: no users
- Input 1 pre-selected in All Outputs
- DSP: all disabled.
- General Volume: Vol = 100%
- Pagers / duckers: disabled.
- Remote panels: no remote panels
- Pilot panels: no pilot panels

TP-NET PROTOCOL

SOFTWARE

Third-Party NET

USER MANUAL

28. TP-NET PROTOCOL INTRODUCTION

The TP-NET protocol lets a client device (control device) get and/or set the values of several parameters of the **EclerNet compatible devices** (MIMO and MIMO SG series digital matrices, DUO-NET PLAYER, NXA digital audio manager series, NZA amplifier series, NPA amplifier series, etc.), like volumes, mutes, alarms, etc. It's **as well available for** eMIMO1616 digital matrix, **HUB series digital zoner**, MIMO7272DN and MIMO4040CDN digital matrix.

The communication with these digital audio devices can be established using Ethernet and the UDP/IP transport protocol, always by means of the **5800** UDP port.

A second option for this communication is using the RS-232 interface that some of these compatible devices do also have (MIMO series, DUO-NET PLAYER, NXA series, etc.). In this case, the serial connection must fulfil the following specifications:

- Baud rate: **57600** (fixed, no autonegotiation) for all the devices, except for DUO-NET PLAYER, eMIMO1616, HUB series and MIMO4040CDN, which use **115200** baud rate)
- Data bits: 8
- Parity: None
- Stop bits: 1
- Flow control: None

In case the Ecler device has an Euroblock connector for the RS-232 interface, the serial cable wiring, from the device's connector to a standard DB9 serial interface connector, must be the following:

WIRING RS232 – DB9	
RS232	DB9
Tx	Pin 2 (RxD)
Rx	Pin 3 (TxD)
Gnd	Pin 5 (Signal Gnd)

The protocol is simple and direct, making it easy to read, write and modify the generated code. It is based on messages with no begin and end delimiter: each message is self-delimited by the UDP packet size, which is defined with a maximum of **80 characters**. All the messages must be written in capital letters.

To let some control systems (like CRESTRON®, EXTRON®, AMX®, RTI®, VITY®, MEDIALON®, etc.) process the messages more easily, the EclerNet device adds the character **LF (0x0A)** to the end of each message. This way the client can buffer the messages to process them, if it's required. The EclerNet device can also handle several messages received in a single message packet by using the **LF** delimiter.

The available messages are built with one or more fields separated with blank spaces (= blank space):

<TYPE> [PARAM1] [PARAM2] [PARAM3] [PARAM4][LF]

The first field (**TYPE**) defines the **message type** and then, the required parameters for it (each kind of message requires a given number of parameters). The field **TYPE** can have these values:

- **SYSTEM**
- **GET**
- **SET**
- **INC**
- **DEC**
- **SUBSCRIBE**
- **UNSUBSCRIBE**
- **DATA**
- **ERROR**

At the end of this document, you'll find all the available messages and their parameters for each model of the EclerNet compatible devices.

The **SYSTEM, GET, SET, INC, DEC, SUBSCRIBE & UNSUBSCRIBE** messages can be sent from the client to the EclerNet device. The **DATA & ERROR** messages can be sent from the device to the client. The only exception is the **SYSTEM PING** message, that is a **SYSTEM** type message that is sent from the EclerNet device when the initial message from the client to the device was **SYSTEM CONNECT PINGPONG**.

The communication (using UDP or RS-232) starts when a client sends the message **SYSTEM CONNECT** to the EclerNet device. As far as the UDP communication requires no connection (unlike the TCP), the EclerNet device stores this client's IP address, and then uses it as the destination IP address for the messages that it generates (**DATA & ERROR**). After receiving the **SYSTEM CONNECT** message, the device dumps its entire configuration using several consecutive **DATA** messages.

Note: if the configuration data dump process (usually a huge list of parameters & values) wants to be avoided after a **SYSTEM CONNECT** message, a **SYSTEM CONNECT ONCE** message can be used instead.

The communication can be terminated by two methods:

- **Manually:** when the client sends the **SYSTEM DISCONNECT** message, cancelling all the subscriptions and stopping the **DATA & ERROR** messages

- **Automatically:** in case the initial message was **SYSTEM CONNECT PINGPONG** and the client didn't get any **SYSTEM PONG** message in a period longer than 10 seconds (presuming a communication breakdown)

The **SET** messages don't have an automatic acknowledgement with a **DATA** message sent from the EclerNet device after it has processed the **SET** command. The client must update the values itself and must send the needed **GET** message if it requires confirmation from the device.

NOTES:

- The numerical values are always integer numbers without +, -, comma or dot symbols.
- **[PINGPONG]** is an optional parameter used to configure the device-client communication with a periodical check, to see whether the client or the device have terminated it. When configured this way, the device sends a **SYSTEM PING** once per second, and the client must answer with a **SYSTEM PONG** message. If anyone doesn't get these messages along a 10 seconds period, the communication will be considered terminated.
- **[ONCE]** is an optional parameter used to start the device-client communication without a full data dump process (usually a huge list of parameters & values).
- **<Input Channel>** & **<Output Channel>** are numerical values that identify an input or output channel of the EclerNet device.
- **<Preset Number>** is a numerical value that identifies one available Preset stored in the EclerNet device's memory.
- **<Level>**, **<Pre Vumeter Level>** y **<Post Vumeter Level>** are numerical values in the [0..100] range that define values in a scale equivalent to [-inf..0] dB
- **<GPI>** & **<GPO>** are numerical values.
- **<GPI Value>** is a numerical value within the [0..100] range that indicates the value of an analogue GPI input. For a digital input only 0 or 100 are the possible values
- **<GPO Value>** is a numerical value within the [0..1] range: it can only be 0 or 1 (opened or closed GPO)
- **<Rate>** is a numerical value within the [1..10] range that sets the VU-meter refresh rate, or the number of times the vumeters' values are sent per second (by default = 3)
- **"<Device Name>"** is the device name inside double quotation marks, to allow for names with blank spaces.
- **<Error ID>** is a numerical value for an error code.
- **"<Error Description>"** is a text chain inside double quotation marks, containing an error description.
- **<Virtual Control>** is a numerical value that identifies a Virtual Control

29. HUB SERIES DIGITAL ZONER

IMPORTANT NOTE: The communication must be started with the client sending **the first message** **SYSTEM CONNECT** or **SYSTEM CONNECT ONCE** to the device. Otherwise, the commands from the client to the EclerNet device will be ignored. [See chapter TP-NET Protocol for additional information.](#)

TYPE	PARAM1	PARAM2	PARAM3	PARAM4	DESCRIPTION
SYSTEM	CONNECT	[PINGPONG]	[ONCE]		Saves the client IP address for responses and then dumps current device status (with DATA messages)
	DISCONNECT				Cancel subscriptions and terminates communication
	SUBSCRIPTION_RATE	<Rate>			Alive message from device
	PING_INTERVAL	<1-1000>			Ping Interval, in seconds
	PING				Alive message from device
	PONG				Alive ACK message from client
GET	ALL				Dumps current device status (with DATA messages)
	INFO_NAME				Gets the Device Name
	INFO_MODEL				Gets the Device Model
	INFO_VERSION				Gets the Firmware Version
	INFO_MAC				Gets the Device MAC address
	IP_CONFIG				Gets the Device network configuration
	INFO_IPLIST				Gets the list of clients connected to the Device
	INAME	<Input Channel>			Gets the NAME (label) of an Input Channel
	ILEVEL	<Input Channel>			Gets the current LEVEL of an Input Channel
IMUTE	<Input Channel>			Gets the current MUTE status of an Input Channel	

IBASSGAIN	<Input Channel>			Gets the current BASS EQ filter GAIN of an Input Channel
IMIDGAIN	<Input Channel>			Gets the current MID EQ filter GAIN of an Input Channel
ITREBLEGAIN	<Input Channel>			Gets the current TREBLE EQ filter GAIN of an Input Channel
IVU	<Input Channel>			Gets the VU-meter value of an Input Channel
ONAME	<Output Channel>			Gets the NAME (label) of an Output Channel
OLEVEL	<Output Channel>			Gets the current LEVEL of an Output Channel
OMUTE	<Output Channel>			Gets the current MUTE status of an Output Channel
OGENVOL				Gets the current LEVEL of the General Volume
OMUTEGENVOL				Gets the current MUTE status of the General Volume
OBASSGAIN	<Output Channel>			Gets the current BASS EQ filter GAIN of an Output Channel
OMIDGAIN	<Output Channel>			Gets the current MID EQ filter GAIN of an Output Channel
OTREBLEGAIN	<Output Channel>			Gets the current TREBLE EQ filter GAIN of an Output Channel
OVU	<Output Channel>			Gets the VU-meter value of an Output Channel
OSOURCESEL	<Output Channel>			Gets the current selected source (input) of an Output Channel

TYPE	PARAM1	PARAM2	PARAM3	PARAM4	DESCRIPTION
SET	IMUTE	<Input Channel>	YES/NO		Sets the current MUTE status of an Input Channel
	ILEVEL	<Input Channel>	<Level>		Sets the current LEVEL of an Input Channel (Level can range from 1 to 100)
	IBASSGAIN	<Input Channel>	<Gain>		Sets the current BASS EQ filter GAIN of an Input Channel (Gain can range from ± 1 to ± 100)
	IMIDGAIN	<Input Channel>	<Gain>		Sets the current MID EQ filter GAIN of an Input Channel (Gain can range from ± 1 to ± 100)
	ITREBLEGAIN	<Input Channel>	<Gain>		Sets the current TREBLE EQ filter GAIN of an Input Channel (Gain can range from ± 1 to ± 100)
	OMUTE	<Output Channel>	YES/NO		Sets the current MUTE status of an Output Channel
	OLEVEL	<Output Channel>	<Level>		Sets the current LEVEL of an Output Channel (Level can range from 1 to 100)
	OGENVOL	<Level>			Sets the current LEVEL of the General Volume (Level can range from 1 to 100)
	OMUTEGENVOL	YES/NO			Sets the current MUTE status of the General Volume
	OBASSGAIN	<Output Channel>	<Gain>		Sets the current BASS EQ filter GAIN of an Output Channel (Gain can range from ± 1 to ± 100)
	OMIDGAIN	<Output Channel>	<Gain>		Sets the current MID EQ filter GAIN of an Output Channel (Gain can range from ± 1 to ± 100)
	OTREBLEGAIN	<Output Channel>	<Gain>		Sets the current TREBLE EQ filter GAIN of an Output Channel (Gain can range from ± 1 to ± 100)
OSOURCESEL	<Output Channel>	<Input>		Sets the selected source (input) for an Output Channel (Input (source) can range from 0 to 16, meaning 0 = no source (silence))	

INC	ILEVEL	<Input Channel >	<Value>		Increases the current LEVEL of an Input Channel by Value (Value can range from ± 1 to ± 100)
	IBASSGAIN	<Input Channel>	<Value>		Increases the current BASS EQ filter GAIN of an Input Channel by Value (Value can range from ± 1 to ± 200 , where 200 means 20.0 -> values are steps like nn.n, with decimal fraction)
	IMIDGAIN	<Input Channel>	<Value>		Increases the current MID EQ filter GAIN of an Input Channel by Value (Value can range from ± 1 to ± 200 , where 200 means 20.0 -> values are steps like nn.n, with decimal fraction)
	ITREBLEGAIN	<Input Channel>	<Value>		Increases the current TREBLE EQ filter GAIN of an Input Channel by Value (Value can range from ± 1 to ± 200 , where 200 means 20.0 -> values are steps like nn.n, with decimal fraction)
	OLEVEL	<Output Channel>	<Value>		Increases the current LEVEL of an Output Channel by Value (Value can range from ± 1 to ± 100)
	OGENVOL	<Value>			Increases the current LEVEL of the General Volume by Value (Value can range from ± 1 to ± 100)
	OBASSGAIN	<Input Channel>	<Value>		Increases the current BASS EQ filter GAIN of an Output Channel by Value (Value can range from ± 1 to ± 200 , where 200 means 20.0 -> values are steps like nn.n, with decimal fraction)
	OMIDGAIN	<Input Channel>	<Value>		Increases the current MID EQ filter GAIN of an Output Channel by Value (Value can range from ± 1 to ± 200 , where 200 means 20.0 -> values are steps like nn.n, with decimal fraction)
	OTREBLEGAIN	<Input Channel>	<Value>		Increases the current TREBLE EQ filter GAIN of an Output Channel by Value (Value can range from ± 1 to ± 200 , where 200 means 20.0 -> values are steps like nn.n, with decimal fraction)

DEC	ILEVEL	<Input Channel >	<Value>		Decreases the current LEVEL of an Input Channel by Value (Value can range from ± 1 to ± 100)
	IBASSGAIN	<Input Channel>	<Value>		Decreases the current BASS EQ filter GAIN of an Input Channel by Value (Value can range from ± 1 to ± 200 , where 200 means 20.0 -> values are steps like nn.n, with decimal fraction)
	IMIDGAIN	<Input Channel>	<Value>		Decreases the current MID EQ filter GAIN of an Input Channel by Value (Value can range from ± 1 to ± 200 , where 200 means 20.0 -> values are steps like nn.n, with decimal fraction)
	ITREBLEGAIN	<Input Channel>	<Value>		Decreases the current TREBLE EQ filter GAIN of an Input Channel by Value (Value can range from ± 1 to ± 200 , where 200 means 20.0 -> values are steps like nn.n, with decimal fraction)
	OLEVEL	<Output Channel>	<Value>		Decreases the current LEVEL of an Output Channel by Value (Value can range from ± 1 to ± 100)
	OGENVOL	<Value>			Decreases the current LEVEL of the General Volume by Value (Value can range from ± 1 to ± 100)
	OBASSGAIN	<Input Channel>	<Value>		Decreases the current BASS EQ filter GAIN of an Output Channel by Value (Value can range from ± 1 to ± 200 , where 200 means 20.0 -> values are steps like nn.n, with decimal fraction)
	OMIDGAIN	<Input Channel>	<Value>		Decreases the current MID EQ filter GAIN of an Output Channel by Value (Value can range from ± 1 to ± 200 , where 200 means 20.0 -> values are steps like nn.n, with decimal fraction)
	OTREBLEGAIN	<Input Channel>	<Value>		Decreases the current TREBLE EQ filter GAIN of an Output Channel by Value (Value can range from ± 1 to ± 200 , where 200 means 20.0 -> values are steps like nn.n, with decimal fraction)
SUBSCRIBE	ALL				Subscribes to all VU-meters

	IVU	<Input Channel>			Subscribes to an Input Channel VU-meter
	OVU	<Output Channel>			Subscribes to an Output Channel VU-meter
UNSUBSCRIBE	ALL				Unsubscribe to all VU-meters
	IVU	<Input Channel>			Unsubscribe to an Input Channel VU-meter
	OVU	<Output Channel>			Unsubscribe to an Output Channel VU-meter

Note: INC and DEC commands are replied with a DATA command from the device with the resulting LEVEL value, after it has been increased or decreased. When the INC or DEC command tries to adjust a LEVEL value beyond its minimum or maximum limits, no reply (DATA command) will be produced.

TYPE	PARAM1	PARAM2	PARAM3	PARAM4	DESCRIPTION
DATA	INFO_NAME	"<Device Name>"			Shows the Device Name
	INFO_MODEL	<Device Model>			Shows the Device Model
	INFO_VERSION	<Firmware Version>			Shows the Firmware Version
	INFO_MAC	<Device MAC address>			Shows the Device MAC address
	IP_CONFIG				Shows the Device network configuration. The message will contain DeviceIP DeviceMask DeviceGateway (separated by blank characters)
	INFO_IPLIST				Shows the list of clients connected to the Device. The message will contain a list including ClientNumber ClientIP Client Port (separated by blank characters)
	INAME	<Input Channel>	<Name>		Shows the NAME (label) of an Input Channel
	ILEVEL	<Input Channel>	<Level>		Shows the current LEVEL of an Input Channel
	IMUTE	<Input Channel>	YES/NO		Shows the current MUTE status of an Input Channel
	IBASSGAIN	<Input Channel>	<Gain>		Shows the current BASS EQ filter GAIN of an Input Channel
	IMIDGAIN	<Input Channel>	<Gain>		Shows the current MID EQ filter GAIN of an Input Channel
	ITREBLEGAIN	<Input Channel>	<Gain>		Shows the current TREBLE EQ filter GAIN of an Input Channel
	IVU	<Input Channel>	<Post Vumeter Level>		Shows the VU-meter value of an Input Channel
	ONAME	<Output Channel>	<Name>		Shows the NAME (label) of an Output Channel
OLEVEL	<Output Channel>	<Level>		Shows the current LEVEL of an Output Channel	

	OMUTE	<Output Channel>	YES/NO		Shows the current MUTE status of an Output Channel
	OGENVOL	<Level>			Shows the current LEVEL of the General Volume
	OMUTEGENVOL	YES/NO			Shows the current MUTE status of the General Volume
	OBASSGAIN	<Input Channel>	<Gain>		Shows the current BASS EQ filter GAIN of an Output Channel
	OMIDGAIN	<Input Channel>	<Gain>		Shows the current MID EQ filter GAIN of an Output Channel
	OTREBLEGAIN	<Input Channel>	<Gain>		Shows the current TREBLE EQ filter GAIN of an Output Channel
	OVU	<Output Channel>	<Post Vumeter Level>		Shows the VU-meter value of an Output Channel
	OSOURCESEL	<Output Channel>	<Input>		Shows the current selected source (input) of an Output Channel. (Input (source) can range from 0 to 16, meaning 0 = no source (silence))
ERROR	<Error ID>	"<Error Description>"			Informs about an error

30. HUB SERIES ERROR CODES

ERROR ID	DESCRIPTION
0	No error. Depending on scenario, can report any of the following: <ul style="list-style-type: none"> • Device is in TEST MODE • Device is in FACTORY MODE • Last loaded project was incomplete • Now Disconnected
1	Invalid Field MSG
2	Depending on scenario, can report any of the following: <ul style="list-style-type: none"> • Invalid Field DATA • Invalid Field VALUE • Invalid Field PARAM1
3	Invalid Field CHANNEL
4	Invalid Field VALUE
7	Timeout Waiting PONG
8	CONNECT received while connected
9	DISCONNECT received while unconnected
10	Invalid client (client not connected)
11	Message too long (more than 80 characters)
12	Message with invalid format
13	Depending on scenario, can report any of the following: <ul style="list-style-type: none"> • Invalid Ping Interval value • Invalid Subscription Interval value
14	Maximum number of clients reached
15	Master Mode active

All product characteristics are subject to variation due to production tolerances. **NEEC AUDIO BARCELONA S.L.** reserves the right to make changes or improvements in design or manufacture that may affect these product specifications.

For technical queries please contact your supplier, distributor or complete the contact form on our website under Support / [Technical Query](#).

Motors, 166-168 08038 Barcelona - España - (+34) 932238403 | information@ecler.com | www.ecler.com