

VEO-XTI1C / VEO-XRI1C

VIDEO DISTRIBUTION OVER IP

H.264 Full HD over IP Video Extenders



USER MANUAL

INDEX

HARDWARE.....4-22

1	IMPORTANT REMARK	4
2	IMPORTANT SAFETY INSTRUCTIONS.....	4
3	IMPORTANT NOTE	6
4	INTRODUCTION.....	6
	4.1 <i>Features</i>	6
5	PACKAGE CONTENTS	7
	5.1 <i>VEO-XTI1C Package.....</i>	7
	5.2 <i>VEO-XRI1C Package</i>	7
6	PANEL DESCRIPTION	8
	6.1 <i>Transmitter Front and Rear Panel.....</i>	8
	6.2 <i>Receiver Front and Rear Panel.....</i>	9
	6.3 <i>IR Sensor and IR Blaster</i>	10
7	INSTALLATION AND CONFIGURATION.....	10
	7.1 <i>IP Address Settings</i>	10
	7.1.1 <i>Static IP Address Configuration</i>	10
	7.1.2 <i>DHCP (Dynamic Host Configuration Protocol).....</i>	11
	7.1.3 <i>Network Requirements</i>	11
	7.2 <i>Point-to-Point Connection and Operation.....</i>	11
	7.3 <i>Point-to-Multipoint Connection and Operation.....</i>	12
	7.4 <i>Multipoint-to-Multipoint Connection and Operation.....</i>	13
8	GROUP ID SELECTION.....	14
	8.1 <i>Group ID and RS-232 baud rate selection using IR Remote Control.....</i>	14
	8.1.1 <i>Group ID</i>	14
	8.1.2 <i>Baud Rate</i>	15
	8.1.3 <i>Special Functions.....</i>	15

8.2	Group ID and RS-232 baud rate Selection via Web Browser	15
8.2.1	Transmitters ID Group:	15
8.2.2	Receivers ID Group:	16
8.2.3	Transmitter and Receiver RS-232 baud rate	16
8.3	Group ID Selection via Telnet.....	16
9	PC UTILITY SOFTWARE.....	17
10	HOW TO RECEIVE STREAMING WITH VLC.....	19
11	FACTORY RESET	21
12	TECHNICAL SPECIFICATIONS.....	22
SOFTWARE.....		23-40
* How to configure a Cisco SG300 Ethernet Switch.....		23-33
13	HOW TO CONFIGURE A CISCO SG300 ETHERNET SWITCH INTRODUCTION	24
14	ESTABLISHING COMMUNICATION WITH THE CISCO ETHERNET SWITCH.....	24
15	ENABLING IGMP PROTOCOL	25
16	ENABLING JUMBO FRAME	29
17	CONFIGURING THE DHCP SERVER.....	30
* How to configure D-Link DGS-1210 Ethernet Switch.....		34-40
18	HOW TO CONFIGURE D-LINK DGS-1210 ETHERNET SWITCH INTRODUCTION	35
19	ESTABLISHING COMMUNICATION WITH D-LINK ETHERNET SWITCH	35
20	ENABLING IGMP PROTOCOL	35
21	ENABLING Jumbo Frame	36
22	Disabling POWER Saving and EEE (Energy Efficient Ethernet).....	37
23	CREATING VLANS FOR DANTE™, VIDEO OVER IP AND CONTROL COEXISTENCE	38

1 IMPORTANT REMARK



WARNING: SHOCK HAZARD - DO NOT OPEN
AVIS: RISQUE DE CHOC ÉLECTRIQUE - NE PAS OUVRIR



The lightning flash with arrowhead symbol, within an equilateral triangle, is intended to alert the user to the presence of uninsulated “dangerous voltage” within the product’s enclosure that may be of sufficient magnitude to constitute a risk of electric shock to persons.



The exclamation point within an equilateral triangle is intended to alert the user to the presence of important operating and maintenance (servicing) instructions in the literature accompanying the appliance.

WARNING (If applicable): The terminals marked with symbol of “” may be of sufficient magnitude to constitute a risk of electric shock. The external wiring connected to the terminals requires installation by an instructed person or the use of ready-made leads or cords.

WARNING: To prevent fire or shock hazard, do not expose this equipment to rain or moisture.

WARNING: An apparatus with Class I construction shall be connected to the main socket-outlet with a protective earthing connection.

2 IMPORTANT SAFETY INSTRUCTIONS

1. Read these instructions.
2. Keep these instructions.
3. Heed all warnings.
4. Follow all instructions.
5. Do not use this apparatus near water.
6. Clean only with dry cloth.
7. Do not block any ventilation openings. Install in accordance with the manufacturer’s instructions.

8. Do not install near any heat sources such as radiators, heat registers, stoves, or other apparatus (including amplifiers) that produce heat.
9. Do not defeat the safety purpose of the polarized or grounding type plug. A polarized plug has two blades with one wider than the other. A grounding type plug has two blades and a third grounding prong. The wide blade or the third prong are provided for your safety. If the provided plug does not fit into your outlet, consult an electrician for replacement of the obsolete outlet.
10. Protect the power cord from being walked on or pinched particularly at the plugs, convenience receptacles, and at the point where they exit from the apparatus.
11. Only use attachments/accessories specified by the manufacturer.
12. Unplug the apparatus during lightning sorts or when unused for long periods of time.
13. Refer all servicing to qualified personnel. Servicing is required when the apparatus has been damaged in any way, such as power supply cord or plug is damaged, liquid has been spilled or objects have fallen into the apparatus, the apparatus has been exposed to rain or moisture, does not operate normally, or has been dropped.
14. Disconnecting from mains: Switching off the POWER switch all the functions and light indicators of the amplifier will be stopped, but fully disconnecting the device from mains is done unplugging the power cord from the mains input socket. For this reason, it always shall remain readily operable.
15. Equipment is connected to a socket-outlet with earthing connection by means of a power cord.
16. The marking information is located at the bottom of apparatus.
17. The apparatus shall not be exposed to dripping or splashing and that no objects filled with liquids, such as vases, shall be placed on apparatus.

NOTE: *This equipment has been tested and found to comply with the limits for a Class A digital device, pursuant to part 15 of the FCC Rules. These limits are designed to provide reasonable protection against harmful interference when the equipment is operated in a commercial environment. This equipment generates, uses, and can radiate radio frequency energy and, if not installed and used in accordance with the instruction manual, may cause harmful interference to radio communications. Operation of this equipment in a residential area is likely to cause harmful interference in which case the user will be required to correct the interference at his own expense.*



WARNING: This product must not be discarded, under any circumstance, as unsorted urban waste. Take to the nearest electrical and electronic waste treatment centre.

NEEC AUDIO BARCELONA, S.L. accepts no liability for any damage that may be caused to people, animal or objects due to failure to comply with the warnings above.

3 IMPORTANT NOTE

Thank you for choosing our VEO-XTI1C & VEO-XRI1C H.264 Full HD over IP Video Extenders. It is **VERY IMPORTANT** to carefully read this manual and to fully understand its contents before making any connection in order to maximize your use and get the best performance from this equipment.

To ensure optimal operation of this device, we strongly recommend that its maintenance be carried out by our authorised Technical Services.

All ECLER products are covered by warranty, please refer to www.ecler.com or the warranty card included with this product for the period of validity and conditions.

4 INTRODUCTION

VEO-XTI1C encoder and VEO-XRI1C decoder are H.264 over IP extenders that allow HDMI video distribution via local Ethernet network. This represents a very flexible, expandable and cost-effective video distribution solution without the need of a dedicated video cabling system. Encoder and decoder support 120m over single Cat5e/6 cable in a point-to-point topology, or standard 100m Ethernet connection in point-to-multipoint and multipoint-to-multipoint over standard Ethernet switch. The over IP solutions are widely suitable for various applications such as meeting rooms, classrooms, commercial and residential AV systems, Digital Signage systems, medical information systems, transportation and mall advertisement.

4.1 Features

- Supports point-to-point, point-to-multipoint and multipoint-to-multipoint configuration
- Up to 120m over single Cat5e/6 cable in point-to-point connection, with 1x looping HDMI output for daisy chaining
- TCP/IP protocol compliant with selectable streaming bit rate up to 15Mbps per stream
- H.264 compression encoding that supports resolution up to 1080p@60hz.
- HDCP Compliant
- IR Remote control, with LED display to show Group ID. Fully operating just out of the box without need of PC connection
- Integrated web server for configuration, PC tool control and Telnet control.
- Supports LPCM audio format
- Wide-band IR pass-through for source control (38khz to 56khz)
- 2-way UART/RS-232 pass-through, with remote control function to select Baud rate

- Dual power input: 802.3af compliant POE & DC 5V (No need of external power supply when encoders and decoders are connected to a POE Switch)
- Included DC 5V/1A international power supply

5 PACKAGE CONTENTS

5.1 VEO-XTI1C Package

- 1 x H.264 Transmitter
- 1 x IR Remote control
- 1 x Local IR Receiver Cable
- 1 x IR Blaster Cable
- 2 x Mounting Ears
- 4 x Screws
- 1 x Phoenix plug for RS-232 cable termination
- 1 x 5V/1A International Power Supply
- 1 x User Manual

5.2 VEO-XRI1C Package

- 1 x H.264 Receiver
- 1 x IR Remote control
- 1 x Local IR Receiver Cable
- 1 x IR Receiver Cable
- 2 x Mounting Ears
- 4 x Screws
- 1 x Phoenix plug for RS-232 cable termination
- 1 x 5V/1A International Power Supply

6 PANEL DESCRIPTION

6.1 Transmitter Front and Rear Panel

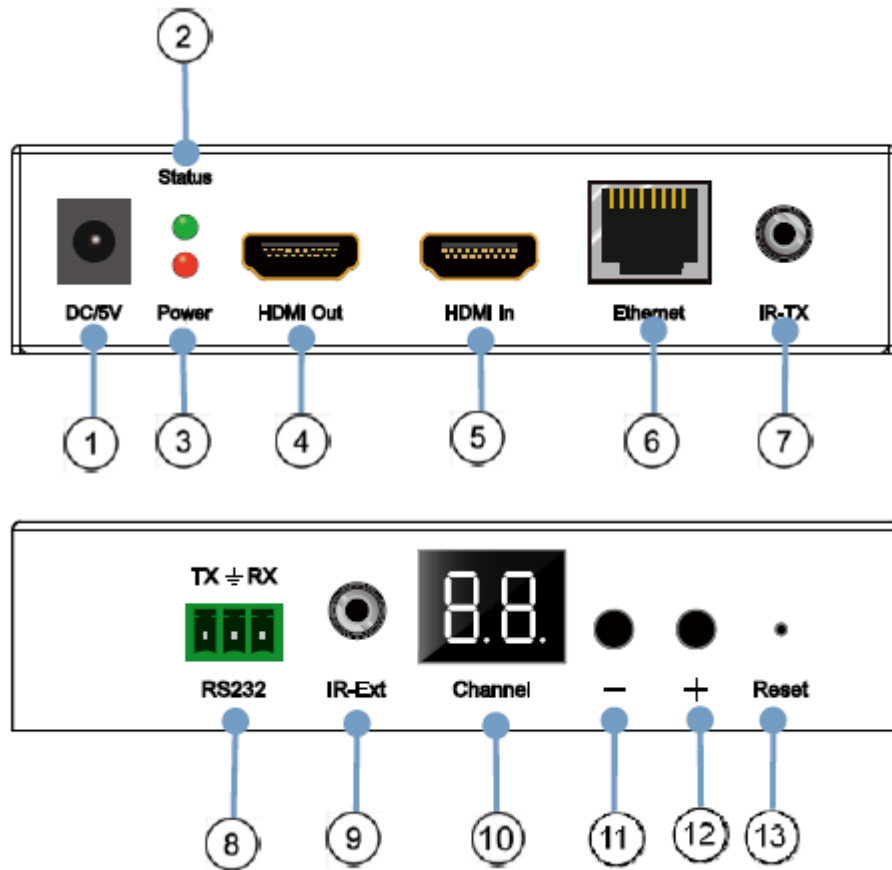

1. DC 5V Power Connector
2. Data Status LED Indicator
3. Power Supply LED Indicator
4. HDMI local loop Output port
5. HDMI Input Port
6. RJ45 Ethernet Port
7. IR Blaster Port
8. Bi-directional RS-232 port
9. Local IR Receiver Port
10. Group ID channel Display
11. Group ID decrement button
12. Group ID increment button
13. Factory reset button

6.2 Receiver Front and Rear Panel

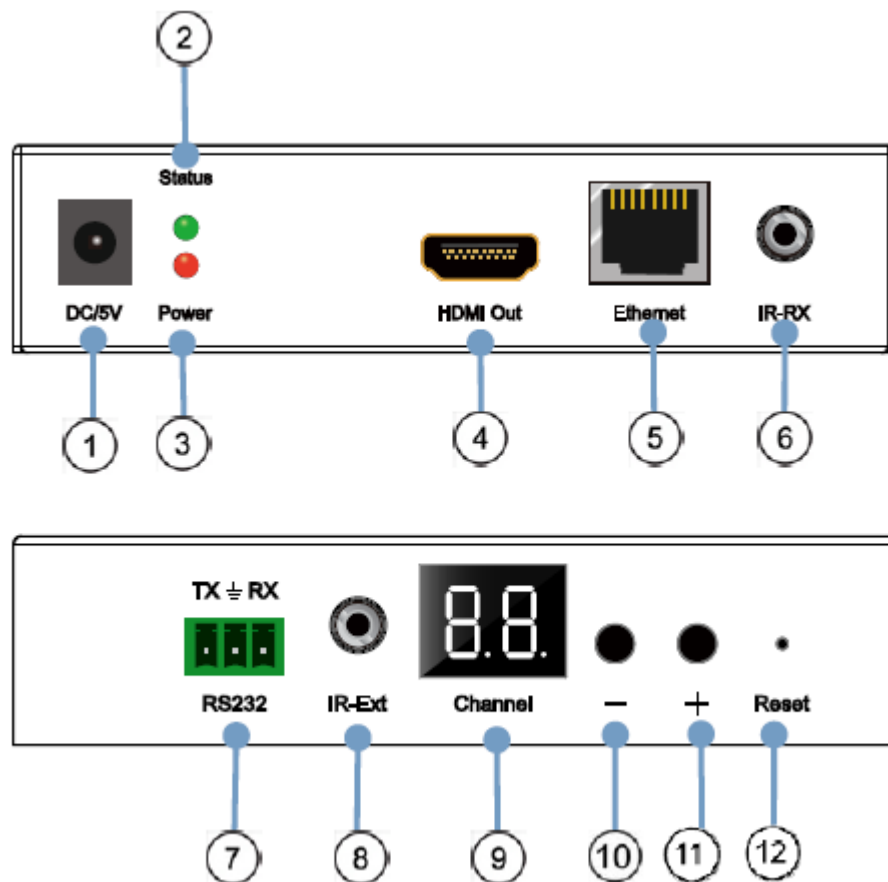

1. DC 5V Power Connector
2. Data Status LED Indicator
3. Power Supply LED Indicator
4. HDMI Output port
5. RJ45 Ethernet Port
6. IR Receiver Port
7. Bi-directional RS-232 port
8. Local IR Receiver Port
9. Group ID number LED Display
10. Group ID number decrement button
11. Group ID number increment button
12. Factory reset button

6.3 IR Sensor and IR Blaster



7 INSTALLATION AND CONFIGURATION

When VEO-XTI1C and VEO-XRI1C are connected as simple extension in a point-to-point connection through a single Cat5e/6 cable, no configuration is needed. When devices are connected to a standard Ethernet LAN in point-to-multipoint or multipoint-to-multipoint topologies, please make sure that every device has unique IP address and every transmitter is using a unique Group ID.

7.1 IP Address Settings

7.1.1 Static IP Address Configuration

When static IP addresses are required, the IP address of each device needs to be set manually. The default IP address for transmitters and receivers is:

- **VEO-XTI1C:** 192.168.1.11
- **VEO-XRI1C:** 192.168.1.12

The IP address can be changed using the embedded web page or using the utility software. For web page access, be sure that PC and VEO devices are in the same Network Domain and just type the default IP address in your internet browser. The default credentials for login are:

- **User name:** admin
- **Password:** admin

After changing default Ethernet settings press the related “Update” button and Reboot the unit.

7.1.2 DHCP (Dynamic Host Configuration Protocol)

If you are using switch or LAN where DHCP server is enabled, changing the IP manually is not necessary because DHCP server will automatically assign a unique IP address to each device.

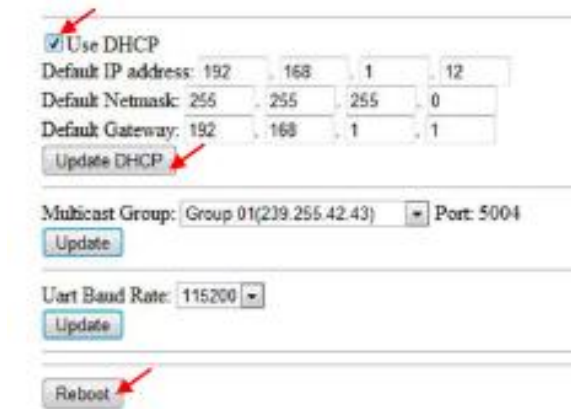

7.1.3 Network Requirements

Transmitters create continuous multicast streaming traffic of video on the network; for this reason, when possible, it is recommended to create an independent IP video network using managed network switches. Use of gigabit switches with jumbo frame and IGMP support is required and will create the most appropriate scenario for both independent IP video networks, and cases where IP video systems are included within your data network.

7.2 Point-to-Point Connection and Operation

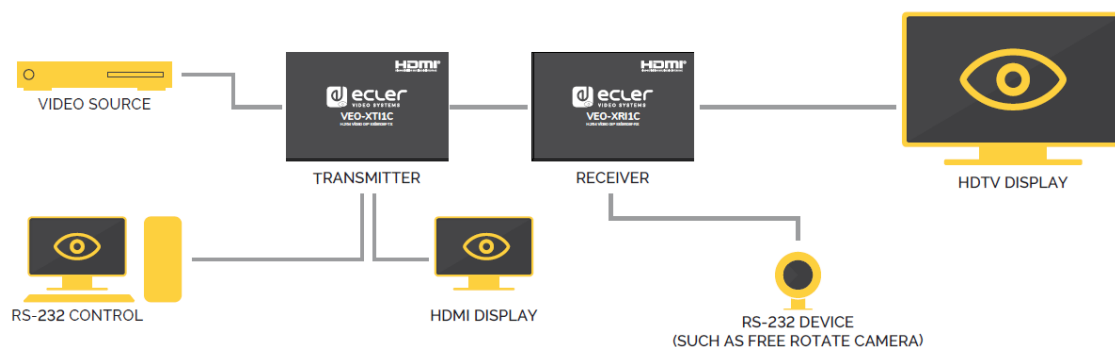

1. Connect source device to the VEO Transmitter HDMI port.
2. Connect Transmitter HDMI looping output to HDMI display.
3. Connect remote HDMI display to the VEO Receiver HDMI port output.
4. Connect Transmitter and Receiver with Cat5e/6 cable

5. Connect IR TX cable to “IR TX” port of the Transmitter; Connect IR RX cable into “IR RX” port of the Receiver. Then you can control source at the RX side using IR.
6. Connect RS-232 Cable from the PC or automation system to Transmitter RS-232 port; connect RS-232 cable from the Receiver to RS-232 port of the device to control.
7. Power on Transmitter and Receiver with adapter 5V 1A.
8. Ensure that the selected Group ID is the same for both devices.

7.3 Point-to-Multipoint Connection and Operation

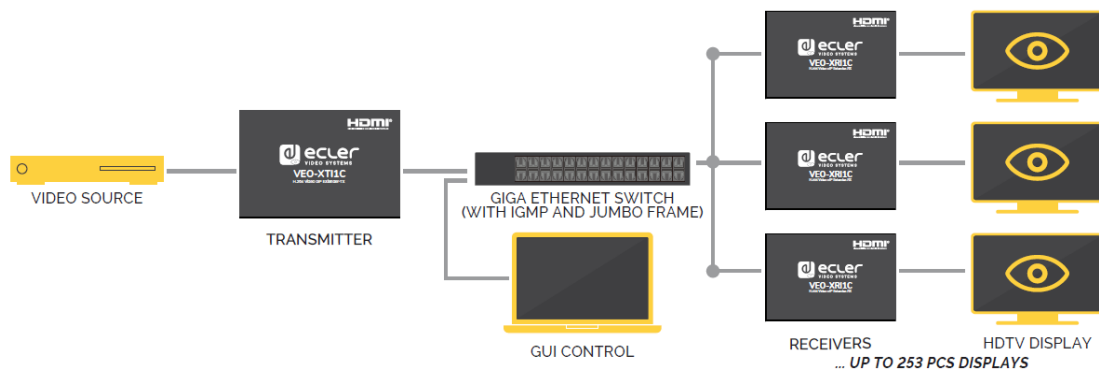

1. Set the IP address for Transmitter & Receiver and prepare the switch
2. Follow steps as instructed above (refer to 6.1)
3. Connect source device and VEO Transmitter with HDMI Cable.
4. Connect HDMI looping output of the VEO Transmitter to a local HDMI display.
5. Connect Transmitter to network switch/router using Cat5e or Cat6 cable.
6. Connect all VEO Receivers and network switch/router using Cat5e/6 cables.
7. Connect HDMI displays to the HDMI VEO Receiver units with HDMI Cable.
8. Connect IR TX cable to “IR TX” port of the transmitter; Connect IR RX cable to “IR RX” port of the receiver. Then you can control source at the RX side with IR.
9. Connect RS-232 Cable from PC or automation system to the Transmitter RS-232 port; connect RS-232 cable from the Receiver to RS-232 port of the device to be controlled.
10. Power on Transmitter and Receiver with adapter 5V 1A and power on network switch. If switch supports PoE (Power over Ethernet), it will not be necessary to power the VEO devices locally.
11. Ensure that the selected Group ID is the same for Transmitters and Receivers.

7.4 Multipoint-to-Multipoint Connection and Operation

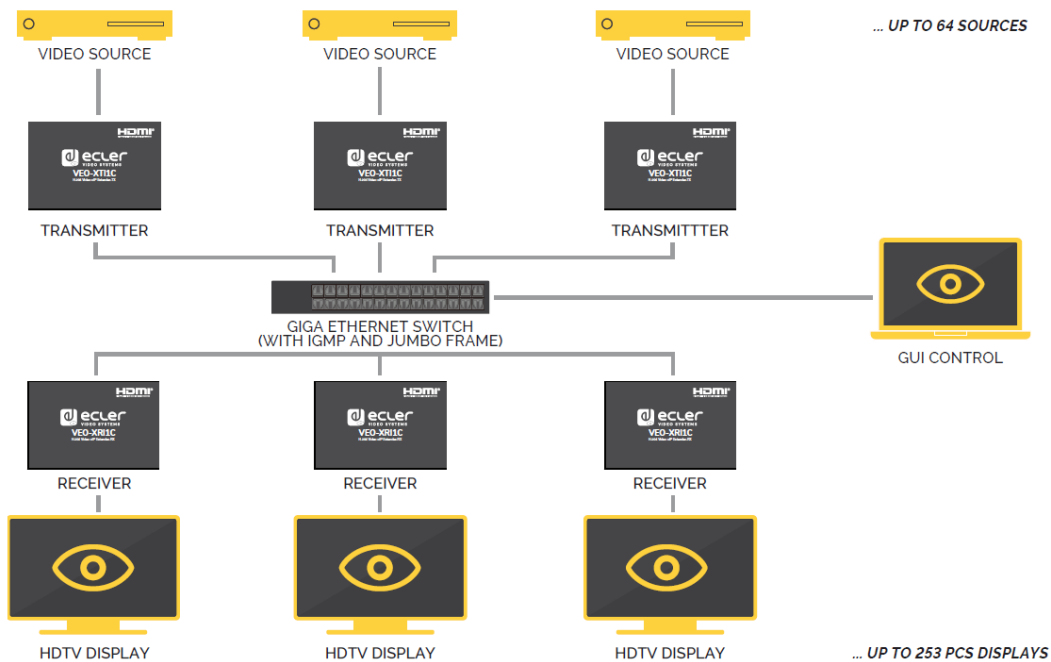

1. Set the IP address for Transmitter & Receiver and prepare the switch
2. Follow the steps as instructed above (refer to 6.1)
3. Connect source devices and Transmitter units with HDMI Cable.
4. Connect HDMI looping output of the VEO Transmitters to local HDMI display.
5. Connect all Transmitters to network switch/router using Cat5e or Cat6 cables.
6. Connect all VEO Receivers and network switch/router using Cat5e/6 cables.
7. Connect HDMI displays and HDMI Receivers with HDMI cable.
8. Connect IR TX cable into "IR TX" port of the transmitter; Connect IR RX cable into "IR RX" port of the receiver. Then you can control source at the RX side with IR.
10. Connect RS-232 cable from the PC or automation system to the RS-232 port of the Transmitter; Connect RS-232 cable from the Receiver to the RS-232 device to be controlled.
11. Power on Transmitter and Receiver with adapter 5V 1A and power the switch. In case the switch supports PoE (Power over Ethernet), it will not be necessary to power the VEO devices locally.
12. Choose correct ID Group as shown in the next chapter of this manual

The number of VEO Transmitters can't exceed 64 units. In a class C Network, total number of VEO devices (Transmitters and Receivers) can't exceed 253 units.

Please avoid connecting or disconnecting HDMI cables when VEO devices are powered on!

8 GROUP ID SELECTION

In multiple sources scenario, each VEO Transmitter can stream a video signal over network using Group ID number that must be unique in the same network. Each Group ID **from 0 to 63** identifies a multicast address and every VEO Receiver can “listen” one of these channels. The Group ID for Transmitters is usually set once during the first installation steps while the receivers ID can change in order to show different content on the displays.

The Group ID can be selected in three different ways:

- Using the IR Remote Control
- Via Web browser
- Using Telnet

8.1 Group ID and RS-232 baud rate selection using IR Remote Control

8.1.1 Group ID

The Group ID can be selected using the included IR remote control. Ensure that IR-Ext sensor is connected (refer to 5.1). The remote control can be used to change Group ID or RS-232 baud rate as explained below.



- Press button ① to switch between Group ID and baud rate function
- When double-digit ID Group number is shown on the display, press “+” or “-” to select Group ID.
- Press the number keys to change Group ID. For example, if you need to change to 01, press “0”, and then press “1”.

Example:



TX 1



RX 1

8.1.2 Baud Rate

The remote control can be used to change RS-232 baud rate.

- Press button ① to switch between Group ID and baud rate function
- When the baud rate function (F0-F7) is shown, press “+” or “-” to select the desired communication speed:
 - F0 = 2400 (default)
 - F1 = 4800
 - F2 = 9600
 - F3 = 19200
 - F4 = 28800
 - F5 = 38400
 - F6 = 57600
 - F7 = 115200

8.1.3 Special Functions

Pressing the ② button for more than 3 seconds, will allow to factory reset the VEO devices. The LED display will start blinking and when it shows “00”, the factory reset is successfully completed.

8.2 Group ID and RS-232 baud rate Selection via Web Browser

When PC is connected to the same network as the VEO devices and it is in the same domain, the Group ID number of each device can be selected using the web page as well as RS-232 baud rate. To access the web page, just type the device IP address in your internet browser. The default credentials are:

- **User name:** admin
- **Password:** admin

8.2.1 Transmitters ID Group:

Stream Setting:

Transfer: Multicast
Multicast IP: Port: 5004

8.2.2 Receivers ID Group:

Multicast Group: Port: 5004

After changing the ID Group, please remember to validate the selection by pressing the “Submit” button on the Transmitter webpage or the “Update” button on the Receiver webpage.

8.2.3 Transmitter and Receiver RS-232 baud rate

VEO-XTI1C and VEO-XRI1C provide full-duplex RS-232 pass-through from TX to RX or from RX to TX allowing the control of third party devices.

The communication will work properly when baud rate and data settings of Transmitter, Receiver and third party RS232 devices are the same.

The default baud rate of Transmitter and Receiver is 2400 but it can be changed through web page by selecting the desired value from 2400 to 115200 bps.

Uart Setting:

Baud Rate:

The RS-232 pass-through works only when the same ID Group is selected.

8.3 Group ID Selection via Telnet

The ID group can also be selected by opening a Telnet session with a standard Telnet terminal, using the port 9999.

When the session is open, send the command **set_group_id n** (where *n* is the number of the desired ID Group) followed by the carriage return and line feed (\r\n).

Example:

```
set_group_id 1           Group ID 01
set_group id 63         Group ID 63
```



9 PC UTILITY SOFTWARE

When the included PC Utility software is installed, ensure that the PC and the VEO devices are on the same network domain.

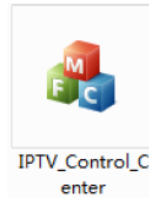
Double-click on the icon to open software:

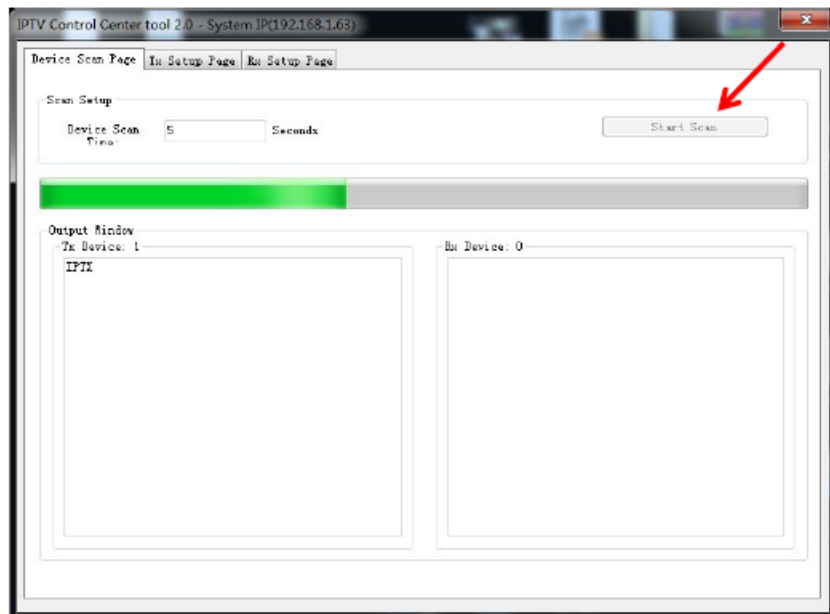

The Device Scan Page will appear:



Press the “Start Scan” button to search for devices on the network.

Using “TX Setup Page” and “RX Setup Page” it is possible to modify several settings and parameters such as Device Name, Network Settings, Video Bitrate, Downscaling options, RS-232 baudrate, Group ID and perform a Device Reboot or a Factory Reset from remote.

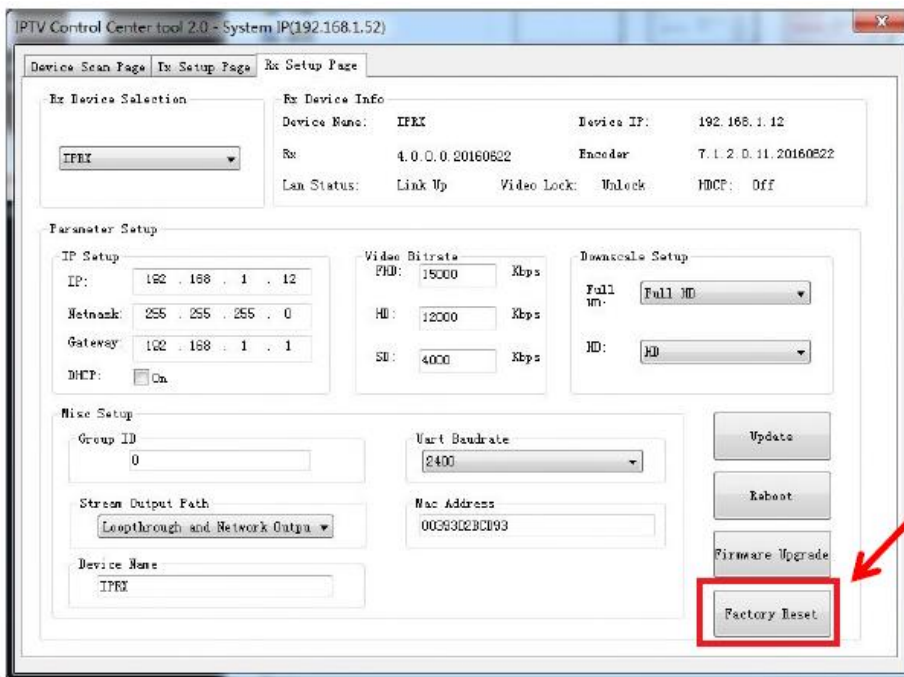
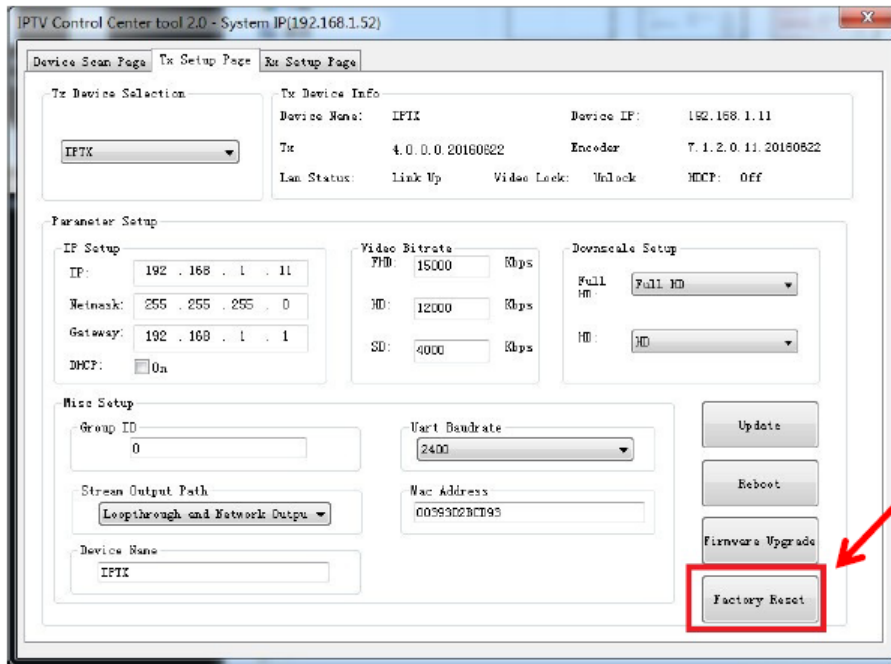

After making any changes please remember to press the “Update” button to save new settings.

10 HOW TO RECEIVE STREAMING WITH VLC

The H.264 video streaming generated by VEO-XTI1C is multicast streaming that can be received using software like VLC (Video LAN Client).

1. Make sure the Transmitter and PC are on the same network domain.
2. Connect HDMI Source without HDCP to the Transmitter HDMI input and Power on the device.
3. Connect transmitter to the network.
4. Check the multicast IP address related to the selected ID Group on the Transmitter Setting web page (refer to 7.2).

Stream Setting:

Transfer: Multicast
 Multicast IP: 00(239.255.42.42) Port: 5004

5. Open the VLC media Player, click “Stream”> “Network”, Input “UDP: //@239.255.42.42 :5004”

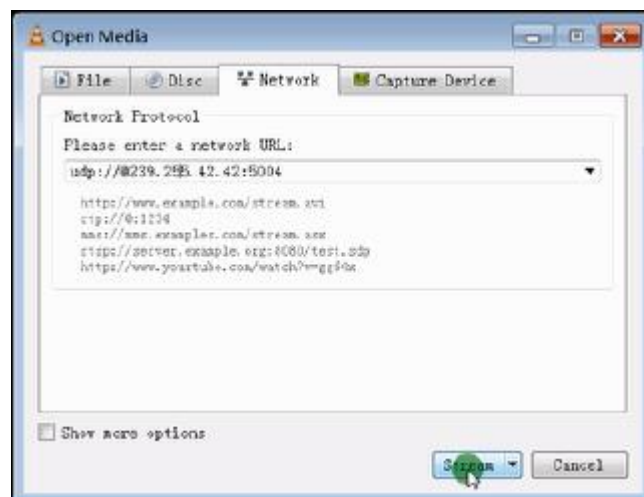
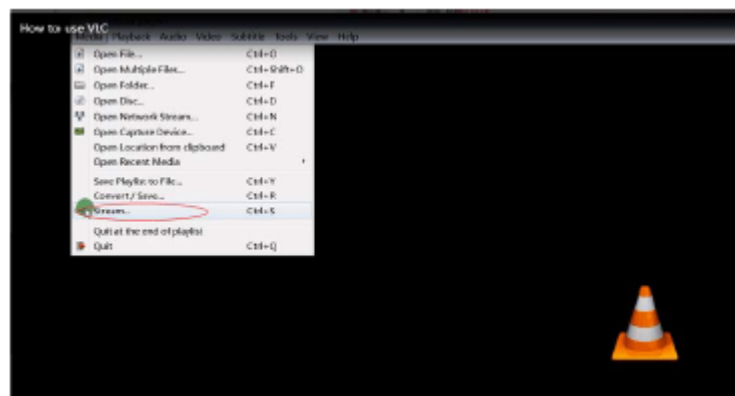

6. Click “Next”.

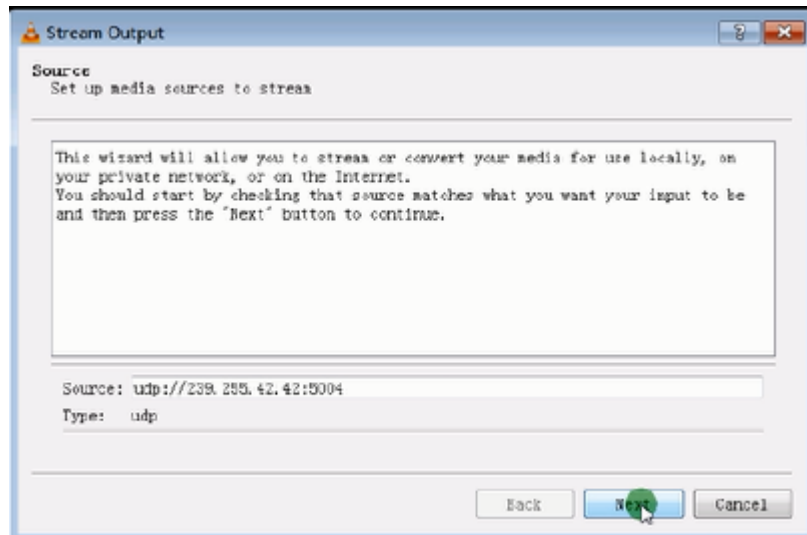

7. Choose "RTP / MPEC Transport Stream" or "UDP".

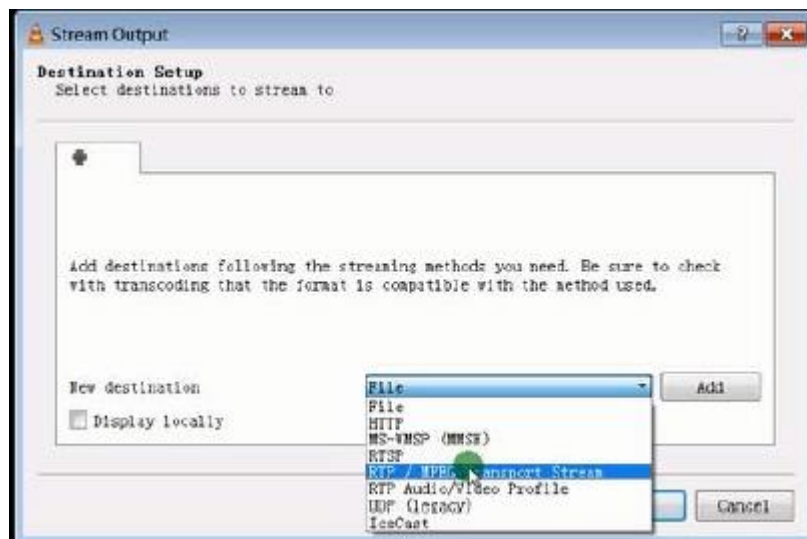

8. Click "Next"

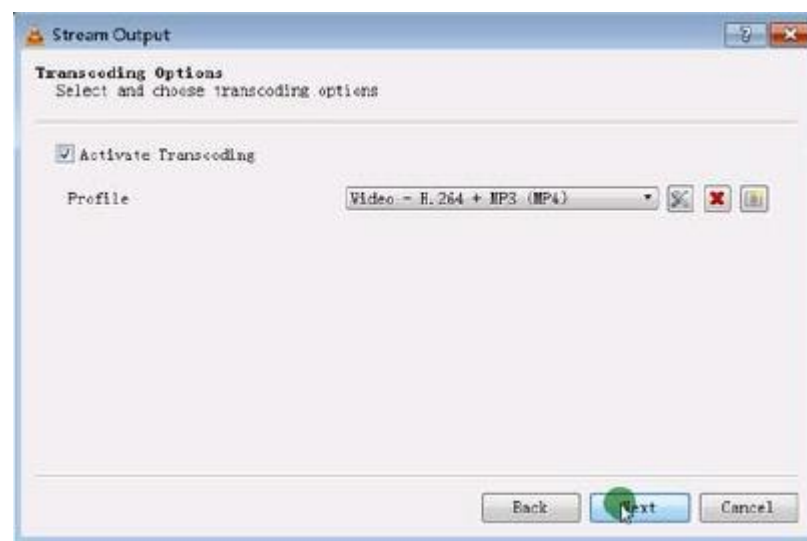

9. Click "Stream".

10. Click “Open Network Stream”, then you can click “Play” to view the video.

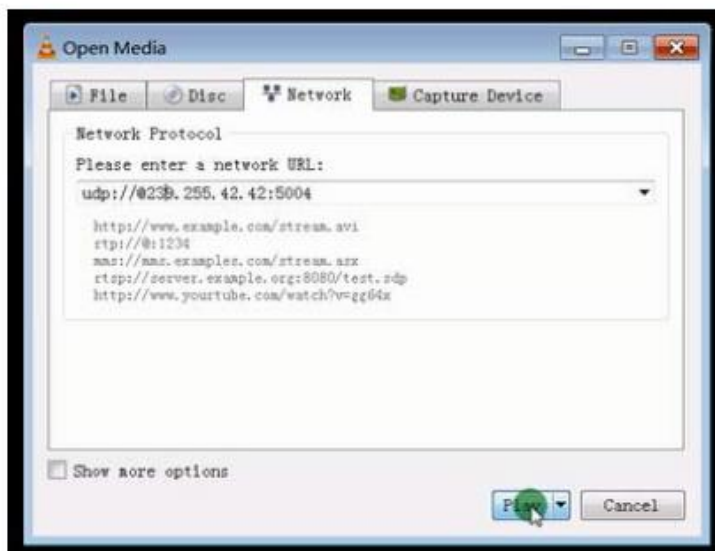
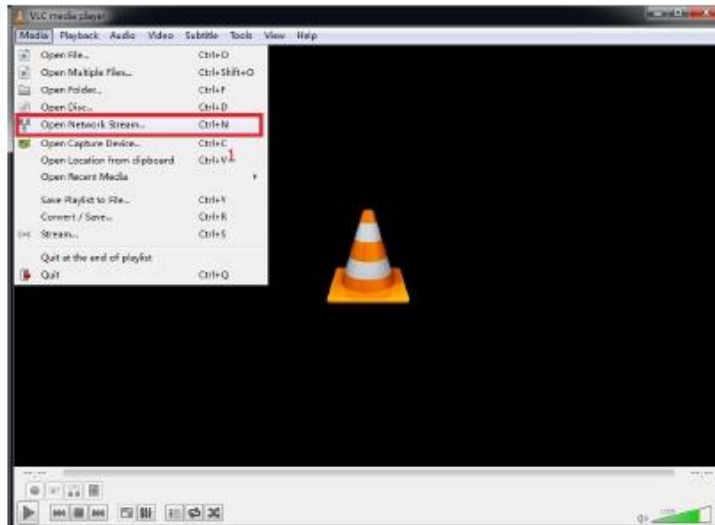

11 FACTORY RESET

The VEO Factory reset can be performed using the PC Utility Software (8), using the remote control (7.1) or by pressing the reset button on the device for 10 seconds using a tiny pin while the unit is powered on. The default IP Address and all the factory parameters will be restored.



12 TECHNICAL SPECIFICATIONS

Supported Resolutions	1080p@24/25/29.97/30/50/59.94/60Hz, 1080i@50Hz, 720p@50/59.94/60Hz, 576p, 576i@50Hz, 480p, 480i@59.94/60Hz Vesa Resolutions@60 Hz: 640×480,800×600,1024×768,1280×768,1280×960, 1280×1024,1680×1050,1920×1080,1280×720, 1360×768,1400×1050
HDCP	1.4 Compliant
Network requirements	IGMP and Jumbo Frames compliance
Network Streaming bitrate	Up to 15Mbps per stream
Video latency	300-500 mS depending on network conditions
Default IP	TX: 192.168.1.11; RX: 192.168.1.12
Audio Formats	LPCM 2.0
Sample Rate	48kHz
Bitrate	24-bit
HDMI Distance	up to 10 meters (33 feet) with Ecler VEO cables
IR supported bandwidth	38 -56 KHZ
Operating Temperature	5°C - 35°C /41°F - 95°F
Humidity	5 - 90% RH (no condensation)
Power Consumption	3W Maximum (TX and RX)
Power Supply	AC100~240V 50/60Hz Output: DC 5V/1A
Dimensions (W x H x D)	VEO-XTI1C: 120 x 30 x 80 mm / 4.72 x 1.18 x 3.15 in. VEO-XRI1C: 119 x 28 x 80 mm / 4.69 x 1.1 x 3.15 in.
Weight	280g (0.617 lbs)

VEO-XTI1C / VEO-XRI1C VEO-XTI2L / VEO-XRI2L

How to configure a Cisco SG300 Ethernet Switch for Ecler VEO over IP products



QUICK START GUIDE

13 HOW TO CONFIGURE A CISCO SG300 ETHERNET SWITCH INTRODUCTION

Due to the network requirements established by Audinate® for Dante™ Networks and taking in consideration the network requirements for our VEO over IP devices, this quick guide aims to explain how to configure the Cisco SG300 family of switches in order to make them compliant to these requirements. All the requirements are mandatory for every switch used in a Dante or VEO over IP system, independently by the brands.

14 ESTABLISHING COMMUNICATION WITH THE CISCO ETHERNET SWITCH

1. Connect your computer to the Cisco Ethernet Switch using an Ethernet cable. The Cisco SG300 Ethernet Switch comes with a default Static IP address of **192.168.1.254**; you must configure your PC with a Static IP address in the same subnet.
2. Set a Static IP address on your computer network interface card, such as 192.168.1.66 along with the following mask 255.255.255.0.
3. Open your Internet browser and digit the default IP address of the switch: <http://192.168.1.254>. The **Default User ID** and **Password** for the unit is "Cisco".

15 ENABLING IGMP PROTOCOL

The IGMP Protocol is mandatory for the correct operation of the VEO over IP products in multicast configurations. Without IGMP the audio/video can't work properly or may freeze.

1. Select **Multicast** → **Properties**. Enable the **Bridge Multicast Filtering Status** by activating the related selection box and clicking on **Apply**.

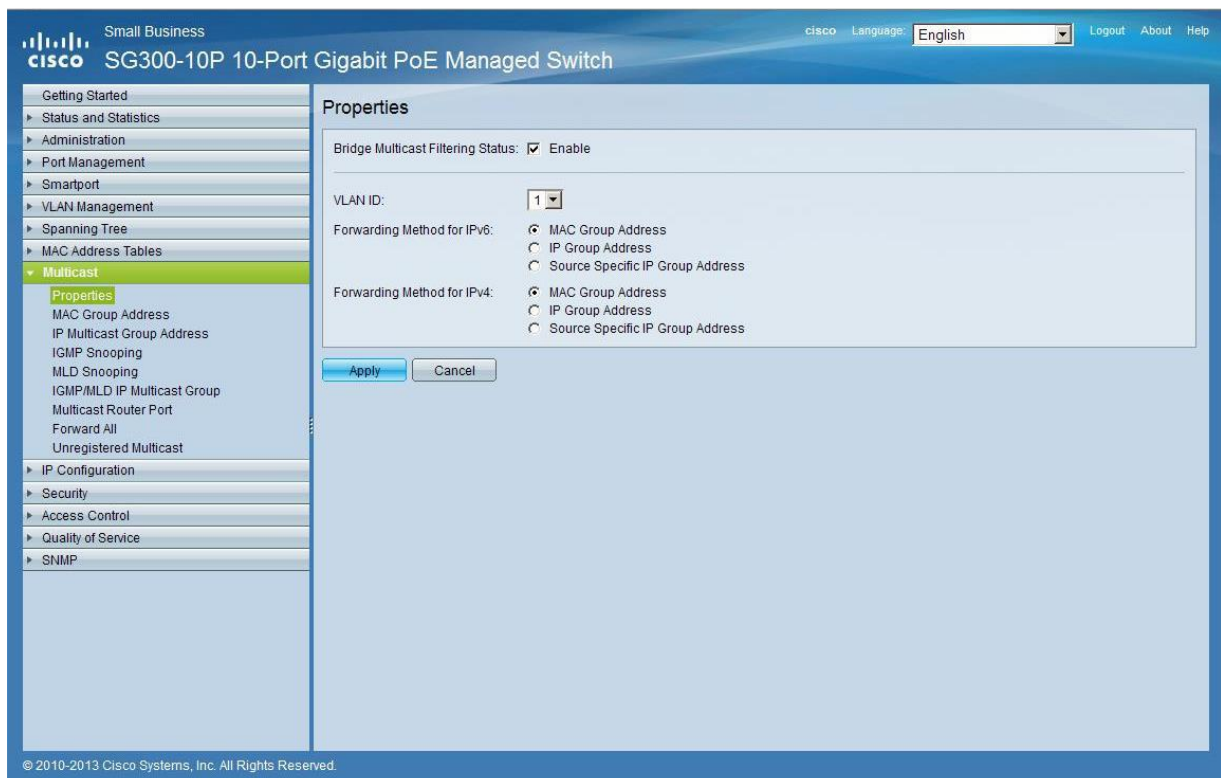

Small Business
cisco Language: English Logout About Help

SG300-10P 10-Port Gigabit PoE Managed Switch

Getting Started
Status and Statistics
Administration
Port Management
Smartport
VLAN Management
Spanning Tree
MAC Address Tables
Multicast
Properties
MAC Group Address
IP Multicast Group Address
IGMP Snooping
MLD Snooping
IGMP/MLD IP Multicast Group
Multicast Router Port
Forward All
Unregistered Multicast
IP Configuration
Security
Access Control
Quality of Service
SNMP

Properties

Bridge Multicast Filtering Status: Enable

VLAN ID: 1

Forwarding Method for IPv6:
 MAC Group Address
 IP Group Address
 Source Specific IP Group Address

Forwarding Method for IPv4:
 MAC Group Address
 IP Group Address
 Source Specific IP Group Address

Apply Cancel

© 2010-2013 Cisco Systems, Inc. All Rights Reserved.

2. Select **Multicast** → **IGMP Snooping**. Enable the **IGMP Snooping Status** by activating the related selection box and clicking on **Apply**.

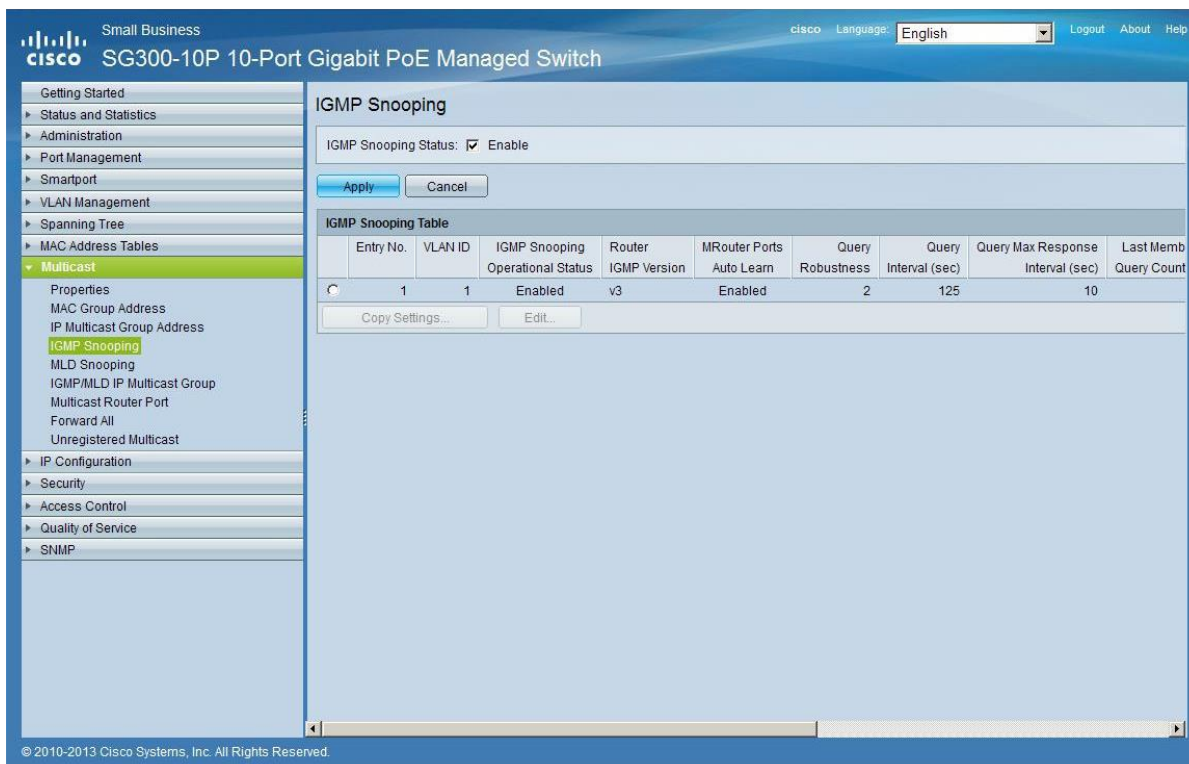

The screenshot shows the configuration page for IGMP Snooping on a Cisco SG300-10P switch. The left sidebar shows the navigation menu with 'Multicast' selected. The main content area shows the 'IGMP Snooping' configuration. The 'IGMP Snooping Status' is checked and set to 'Enable'. Below this is an 'Apply' button and a 'Cancel' button. The 'IGMP Snooping Table' is displayed with the following data:

Entry No.	VLAN ID	IGMP Snooping Operational Status	Router IGMP Version	MRouter Ports Auto Learn	Query Robustness	Query Interval (sec)	Query Max Response Interval (sec)	Last Memb Query Count
1	1	Enabled	v3	Enabled	2	125	10	

Below the table are 'Copy Settings...' and 'Edit...' buttons.

3. In the **IGMP Snooping Table**, select the default **VLAN ID 1** and click on **Edit**.

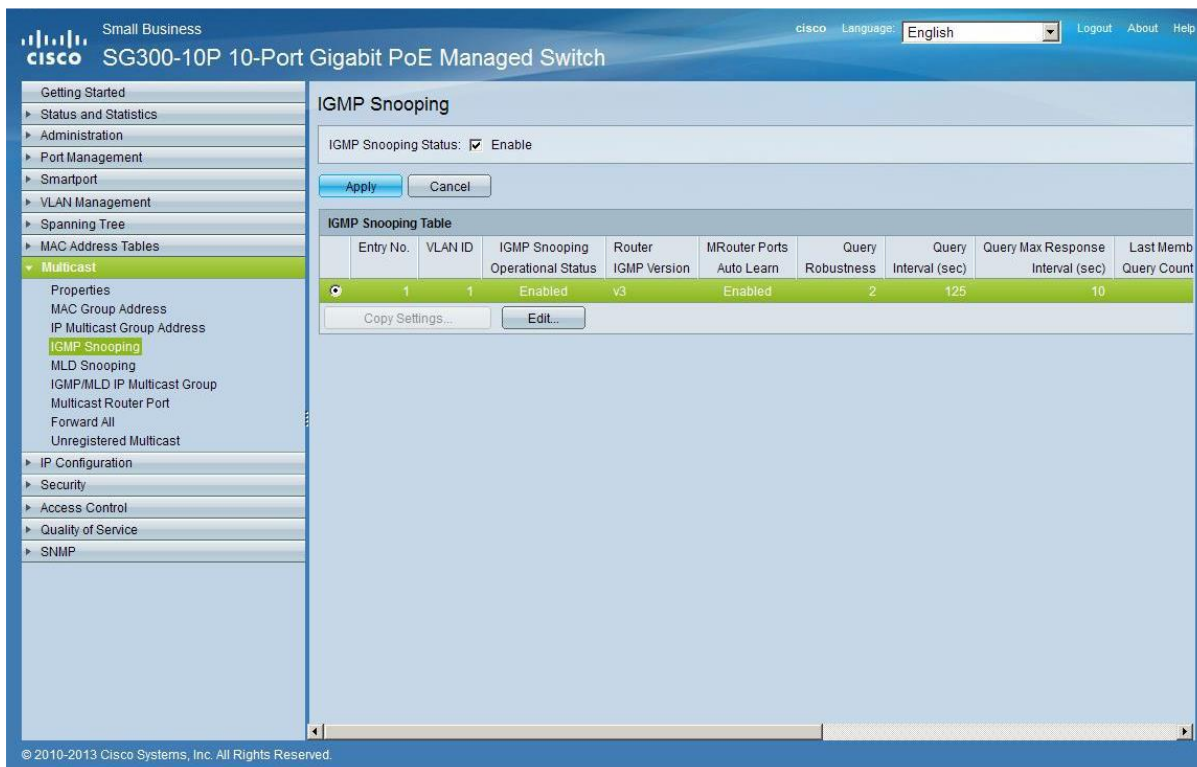

The screenshot shows the same configuration page as above, but now the first entry in the 'IGMP Snooping Table' is selected. The 'Edit...' button is highlighted. The table data is the same as in the previous screenshot:

Entry No.	VLAN ID	IGMP Snooping Operational Status	Router IGMP Version	MRouter Ports Auto Learn	Query Robustness	Query Interval (sec)	Query Max Response Interval (sec)	Last Memb Query Count
1	1	Enabled	v3	Enabled	2	125	10	

- In the resulting window, activate the related selection box for **IGMP Snooping Status** and verify that the **Immediate Leave** selection box is enabled and then click on **Apply**.

VLAN ID:	1		
IGMP Snooping Status:	<input checked="" type="checkbox"/> Enable		Operational IGMP Snooping Status: E
MRouter Ports Auto Learn:	<input checked="" type="checkbox"/> Enable		
Query Robustness:	2 (Range: 1 - 7, Default: 2)		Operational Query Robustness: 2
Query Interval:	125 sec (Range: 30 - 18000, Default: 125)		Operational Query Interval: 1
Query Max Response Interval:	10 sec (Range: 5 - 20, Default: 10)		Operational Query Max Response Interval: 1
Last Member Query Counter:	<input checked="" type="radio"/> Use Default <input type="radio"/> User Defined (Range: 1 - 7, Default: 2 (Query Robustness))		Operational Last Member Query Counter: 2
Last Member Query Interval:	1000 mS (Range: 100 - 25500, Default: 1000)		Operational Last Member Query Interval: 1
Immediate leave:	<input checked="" type="checkbox"/> Enable		
IGMP Querier Status:	<input type="checkbox"/> Enable		
Administrative Querier Source IP Address:	<input checked="" type="radio"/> Auto <input type="radio"/> User Defined 168.168.1.1		Operational Querier Source IP Address:
IGMP Querier Version:	<input checked="" type="radio"/> IGMPV2 <input type="radio"/> IGMPV3		
<input type="button" value="Apply"/> <input type="button" value="Close"/>			

- Select **Administration** → **File Management** → **Copy/Save Configuration**. Enable **Running Configuration** and **Startup Configuration** as shown below and save all changes by clicking **Apply**.

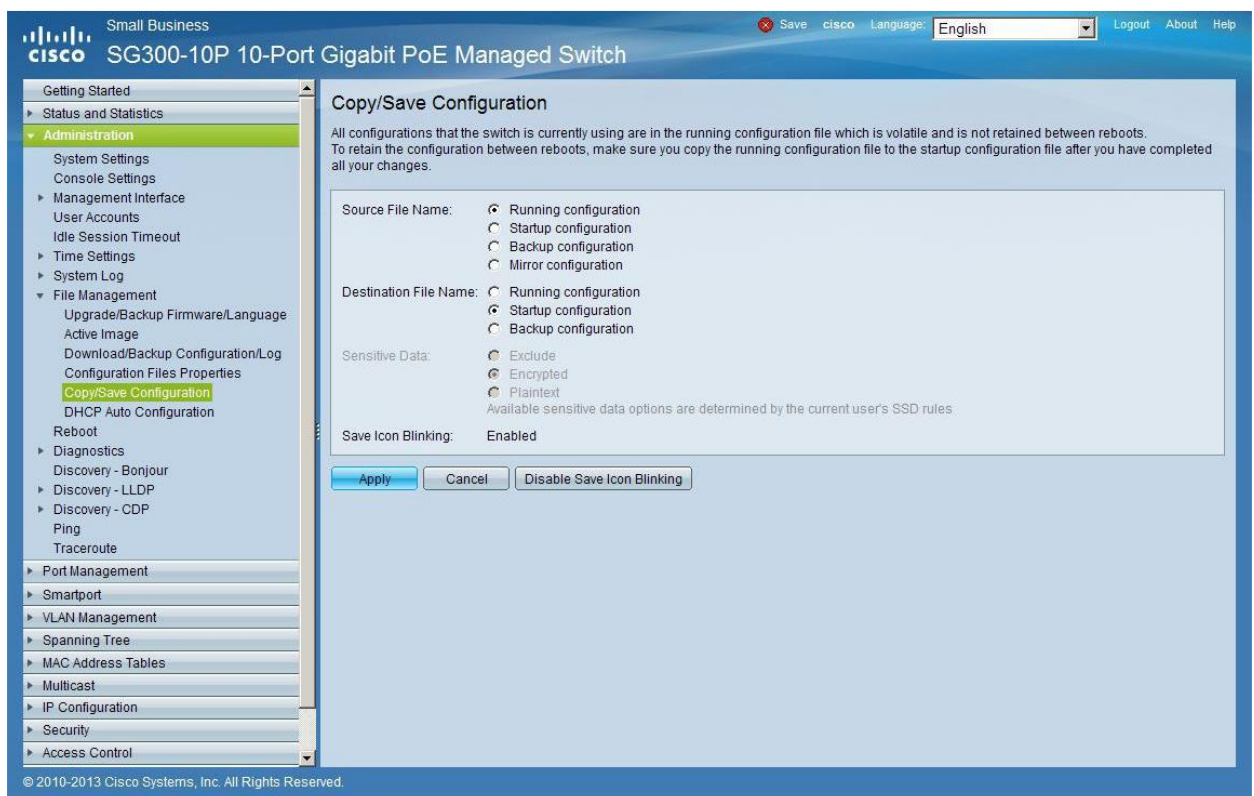

Small Business
 Save cisco Language: English Logout About Help

SG300-10P 10-Port Gigabit PoE Managed Switch

Getting Started
 Status and Statistics
 Administration
 System Settings
 Console Settings
 Management Interface
 User Accounts
 Idle Session Timeout
 Time Settings
 System Log
 File Management
 Upgrade/Backup Firmware/Language
 Active Image
 Download/Backup Configuration/Log
 Configuration Files Properties
 Copy/Save Configuration
 DHCP Auto Configuration
 Reboot
 Diagnostics
 Discovery - Bonjour
 Discovery - LLDP
 Discovery - CDP
 Ping
 Traceroute
 Port Management
 Smartport
 VLAN Management
 Spanning Tree
 MAC Address Tables
 Multicast
 IP Configuration
 Security
 Access Control

Copy/Save Configuration

All configurations that the switch is currently using are in the running configuration file which is volatile and is not retained between reboots. To retain the configuration between reboots, make sure you copy the running configuration file to the startup configuration file after you have completed all your changes.

Source File Name: Running configuration
 Startup configuration
 Backup configuration
 Mirror configuration

Destination File Name: Running configuration
 Startup configuration
 Backup configuration

Sensitive Data: Exclude
 Encrypted
 Plaintext
 Available sensitive data options are determined by the current user's SSD rules.

Save Icon Blinking: Enabled

© 2010-2013 Cisco Systems, Inc. All Rights Reserved.

6. Select **Administration** → **File Management** → **Reboot**, and click on the **Reboot** button to reboot the Ethernet switch and make all the changes running.

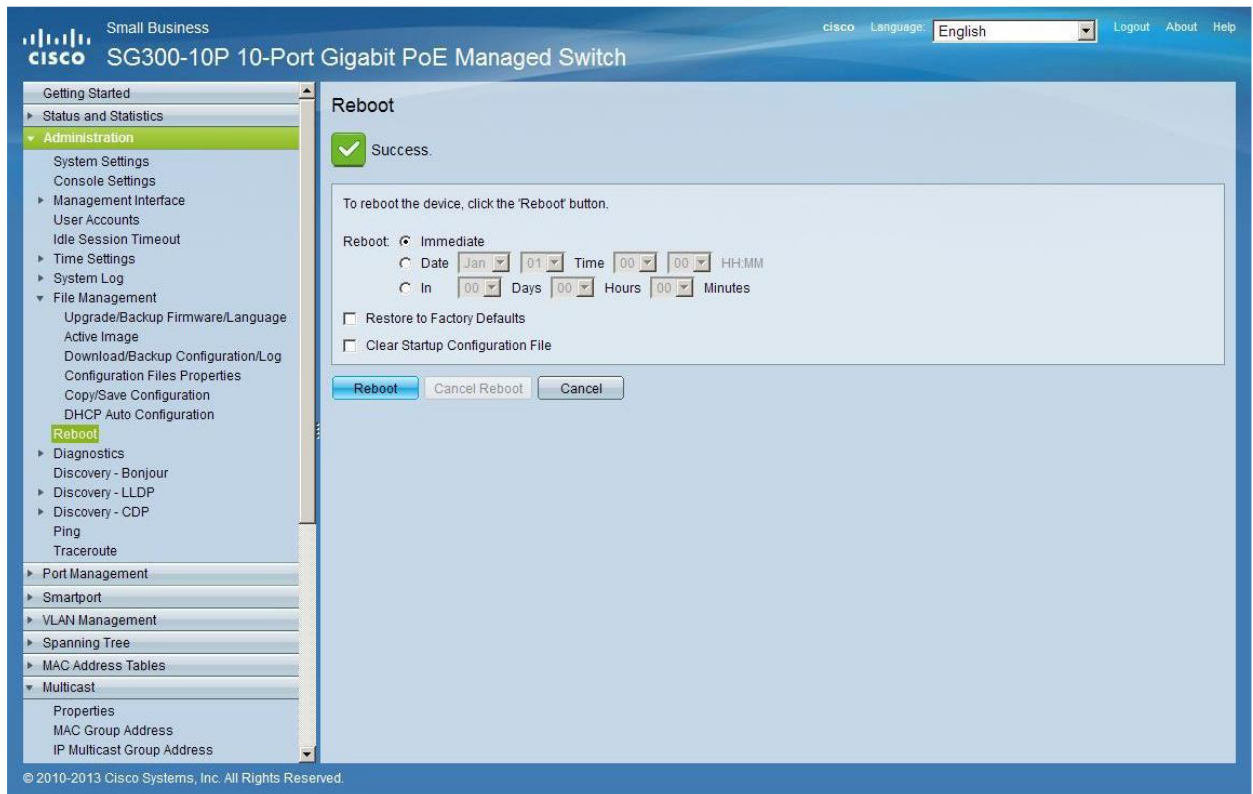

16 ENABLING JUMBO FRAME

1. Select **Port Management** → **Port Settings**. Enable **Jumbo Frames** by activating the related selection box and click on **Apply**.

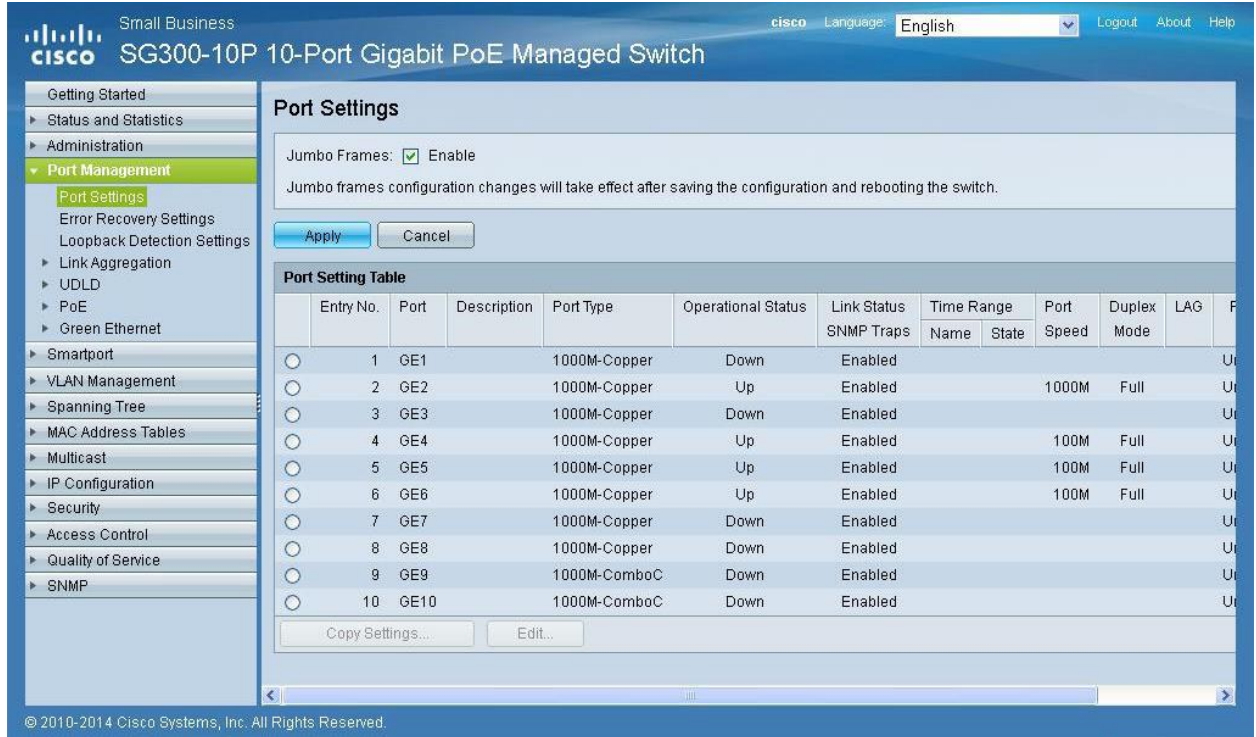

The screenshot shows the Cisco configuration interface for a SG300-10P switch. The 'Port Management' menu is expanded to 'Port Settings'. The 'Jumbo Frames' checkbox is checked and labeled 'Enable'. Below this, a note states: 'Jumbo frames configuration changes will take effect after saving the configuration and rebooting the switch.' There are 'Apply' and 'Cancel' buttons. A 'Port Setting Table' is displayed with the following data:

Entry No.	Port	Description	Port Type	Operational Status	Link Status	Time Range	Port Speed	Duplex Mode	LAG	P
<input type="radio"/>	1	GE1	1000M-Copper	Down	Enabled					U
<input type="radio"/>	2	GE2	1000M-Copper	Up	Enabled		1000M	Full		U
<input type="radio"/>	3	GE3	1000M-Copper	Down	Enabled					U
<input type="radio"/>	4	GE4	1000M-Copper	Up	Enabled		100M	Full		U
<input type="radio"/>	5	GE5	1000M-Copper	Up	Enabled		100M	Full		U
<input type="radio"/>	6	GE6	1000M-Copper	Up	Enabled		100M	Full		U
<input type="radio"/>	7	GE7	1000M-Copper	Down	Enabled					U
<input type="radio"/>	8	GE8	1000M-Copper	Down	Enabled					U
<input type="radio"/>	9	GE9	1000M-ComboC	Down	Enabled					U
<input type="radio"/>	10	GE10	1000M-ComboC	Down	Enabled					U

At the bottom of the table, there are 'Copy Settings...' and 'Edit...' buttons. The footer of the page reads: '© 2010-2014 Cisco Systems, Inc. All Rights Reserved.'

17 CONFIGURING THE DHCP SERVER

The DHCP Server will automatically configure the IP addresses of each device connected to the switch. All the devices need to be set as DHCP client in their own Network Configuration page. This allows avoiding any conflict between devices.

Note: Please check VEO user manual for IP configurations of each product, accordingly to your installation needs.

1. To change the **Ethernet Switch Static IP address** to the same subnet as the AV over IP Devices, select **Administration** → **Management Interface** → **IPv4 Interface**. Set **IP Address Type** to **Static**, and enter the **IP Address** (accordingly to your network requirements), and set the **Network Mask** to 255.255.255.0. In this case we e default IP address. **After applying these settings you need to change the IP address on your computer network interface card to the same subnet just set above.**

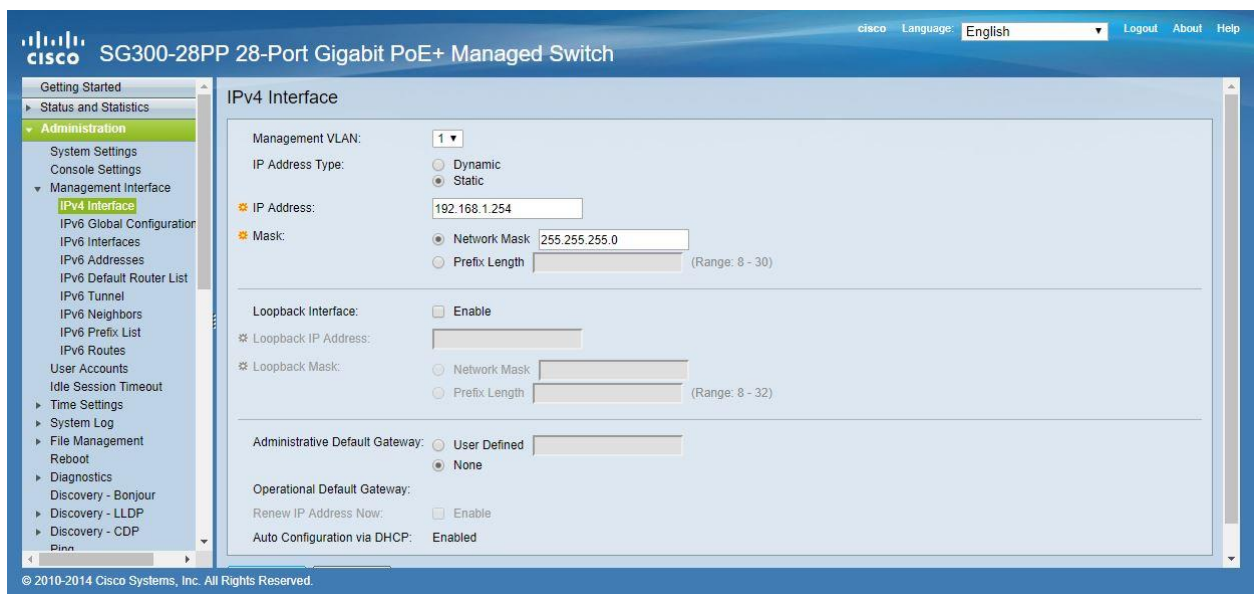

2. Select **IP Configuration** → **DHCP Server** → **Network Pools** and click on the **Add...** button

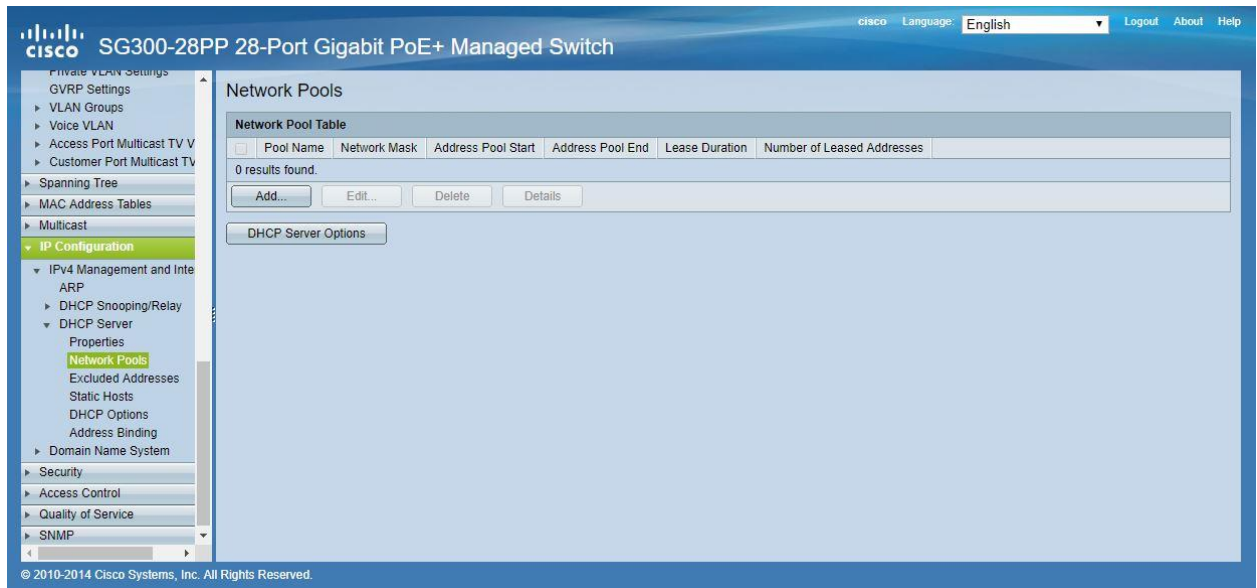

3. Set the **Pool Name**, the **Network Mask** (255.255.255.0), the **Address Pool Start** (192.168.1.10), and the **Address Pool End** (192.168.1.100). Verify that you allocate enough IP addresses for all Transmitters and Receivers present on the network.

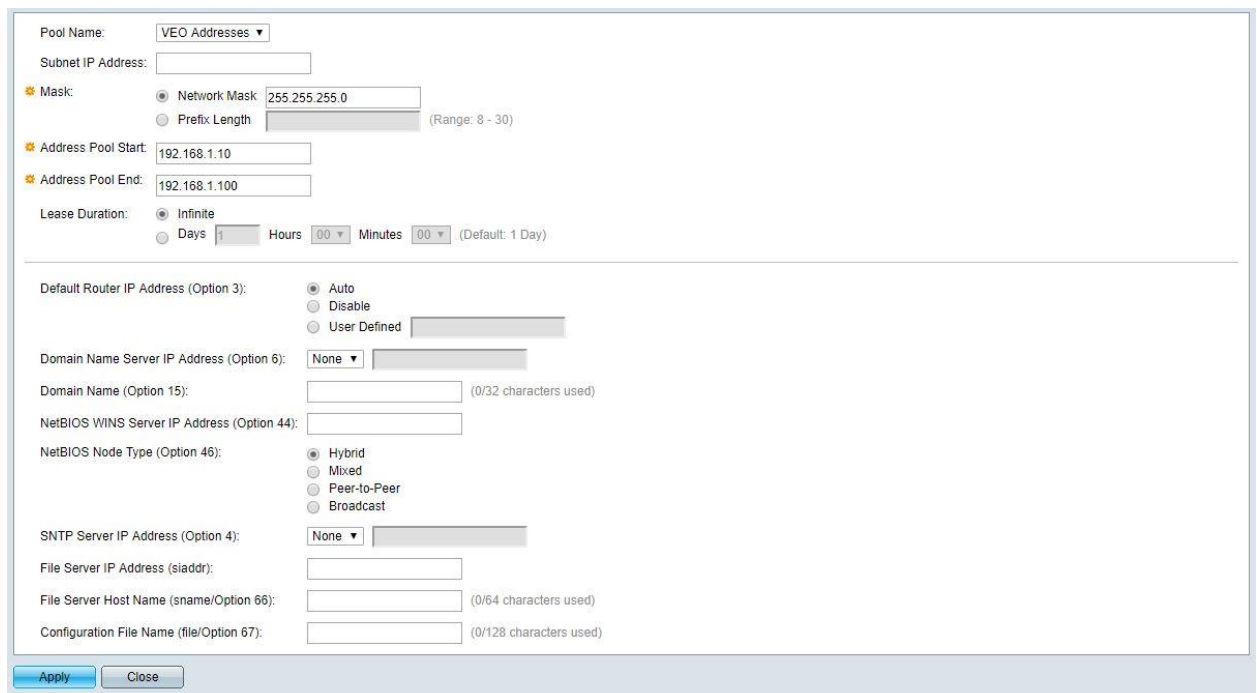

Click on the **Apply** button.

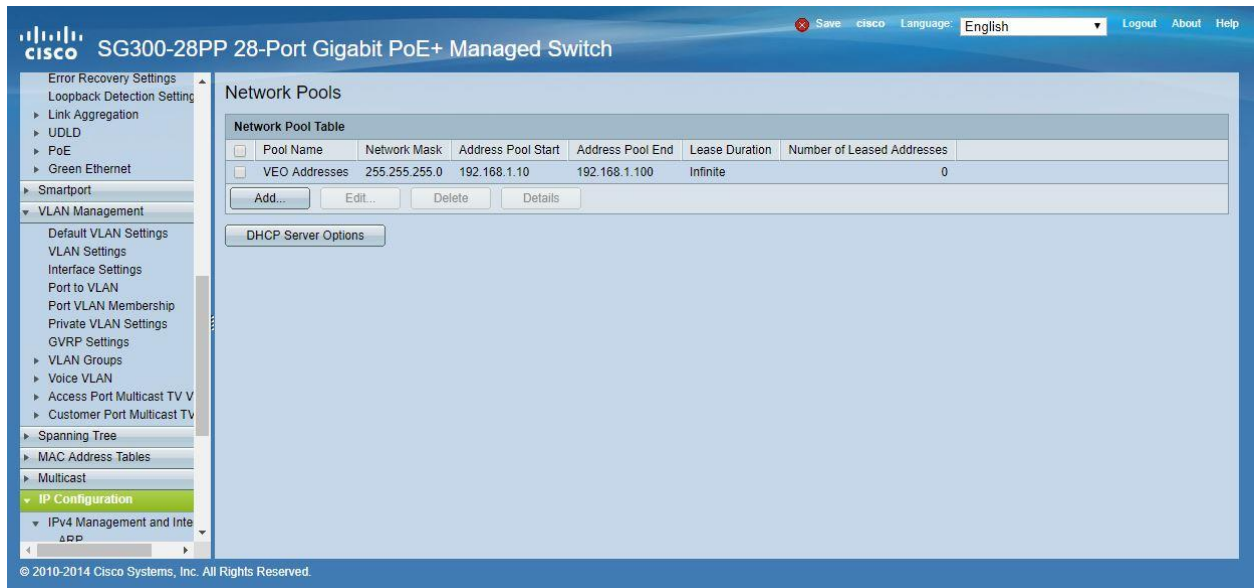

4. Select IP Configuration → IPv4 Management and Interfaces → DHCP Server → Properties.

Enable the **DHCP Server Status** by activating the related selection box and clicking on **Apply**.

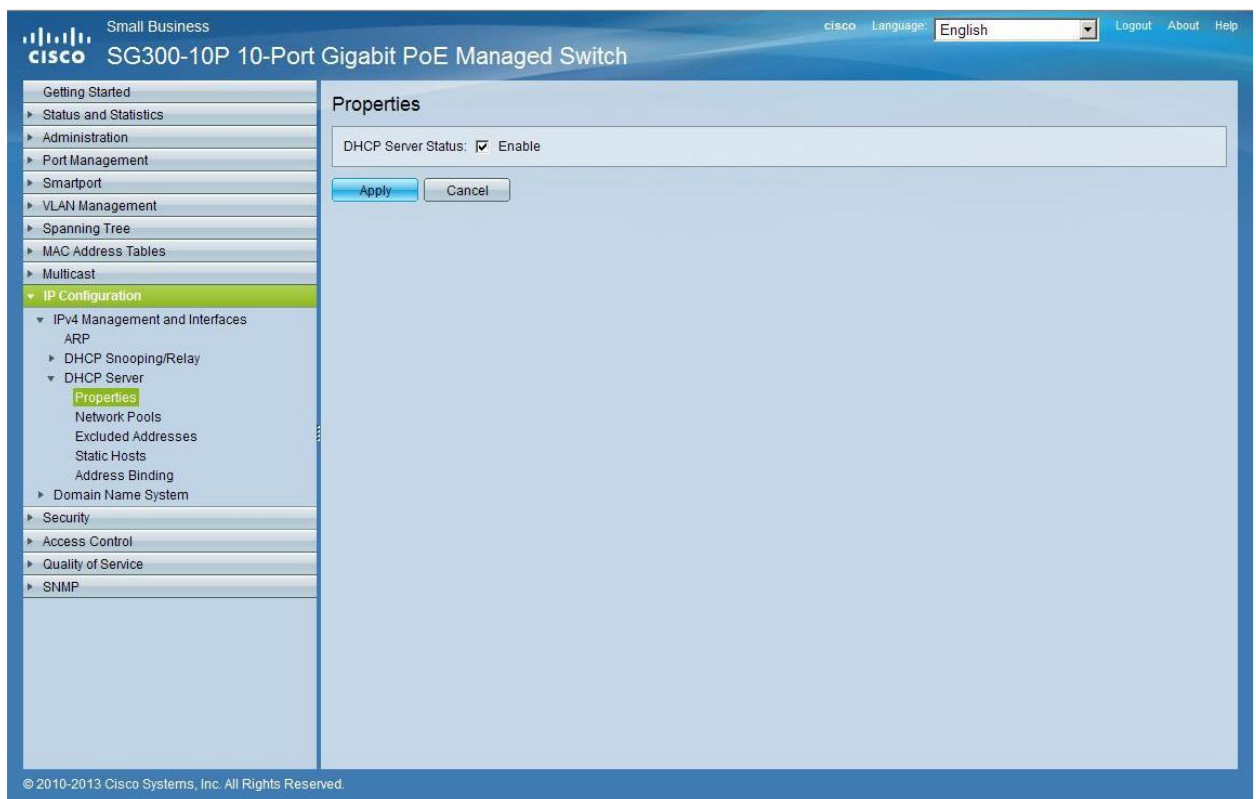

5. Select **Administration** → **File Management** → **Copy/Save Configuration**. Enable **Running Configuration** and **Startup Configuration** as shown below and save all changes by clicking **Apply**.

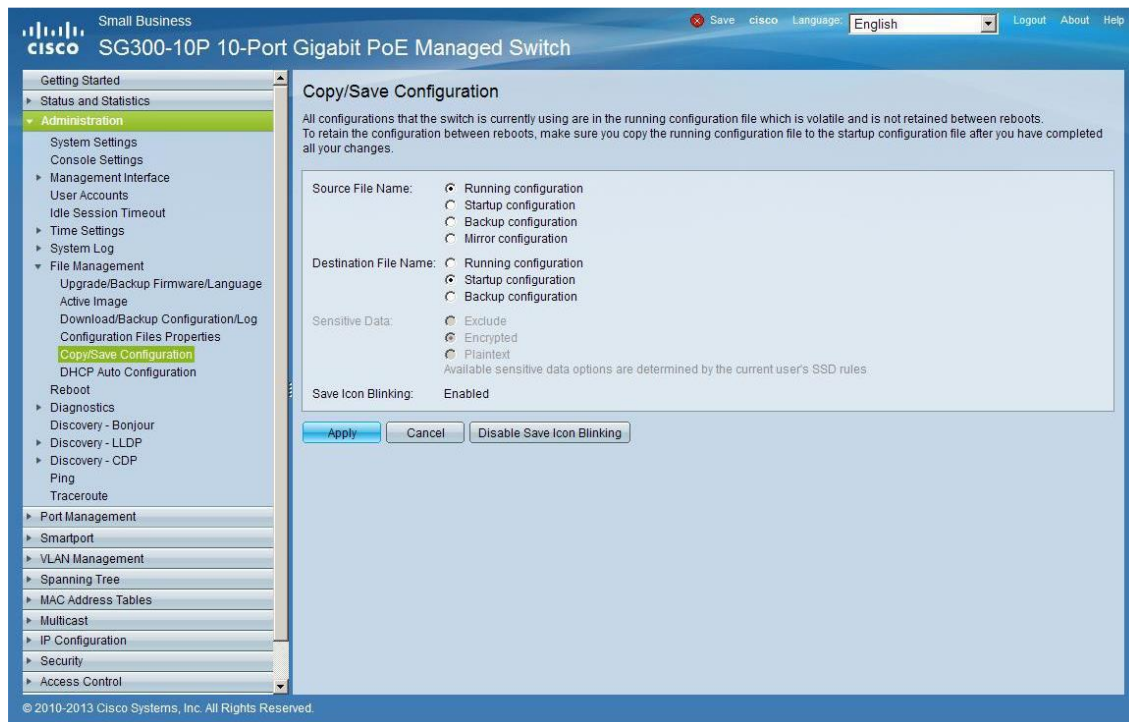

6. Select **Administration** → **File Management** → **Reboot**, and click on the **Reboot** button to reboot the Ethernet switch and make all the changes running.

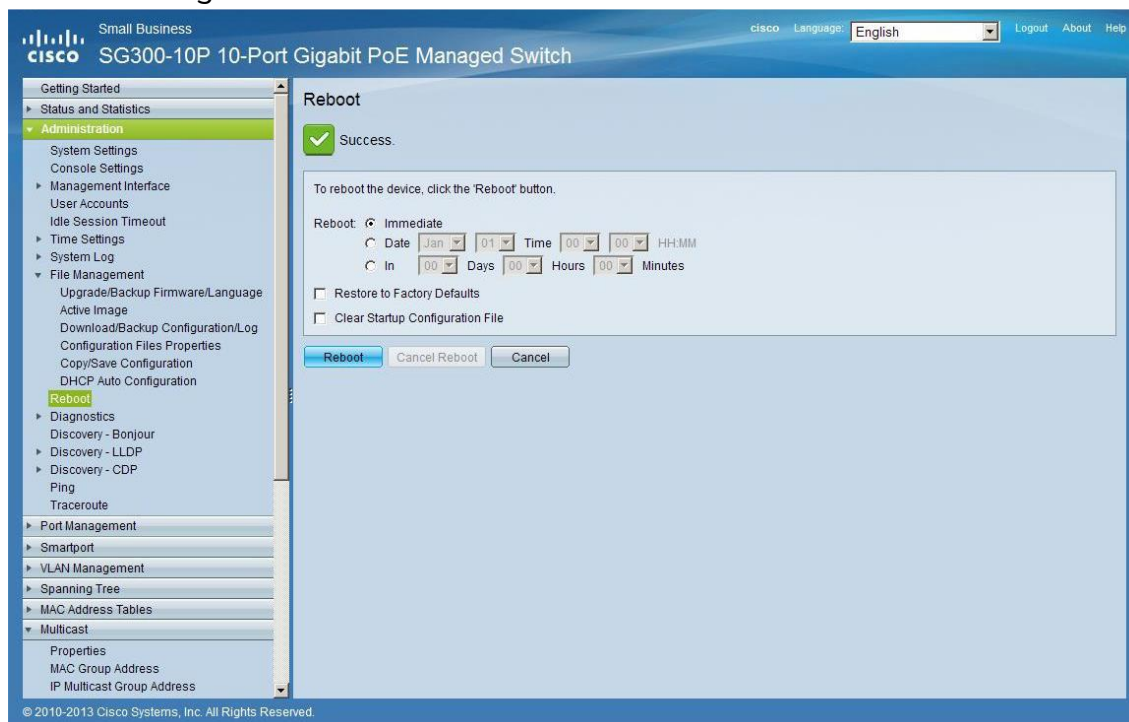

VEO-XTI1C / VEO-XRI1C

VEO-XTI2L / VEO-XRI2L

How to configure D-Link DGS-1210 Ethernet Switch for Dante™ Networks and VEO over IP products



QUICK START GUIDE

18 HOW TO CONFIGURE D-LINK DGS-1210 ETHERNET SWITCH INTRODUCTION

Due to the network requirements established by Audinate® for Dante™ Networks and taking in consideration the network requirements for our VEO over IP devices, this quick guide aims to explain how to configure the D-Link DGS-1210 family of switches in order to make them compliant to these requirements. All the requirements are mandatory for every switch used in a Dante or VEO over IP system, independently by the brands.

19 ESTABLISHING COMMUNICATION WITH D-LINK ETHERNET SWITCH

4. Connect your computer to the D-Link Ethernet Switch using an Ethernet cable. D-Link DSG-1210 Ethernet Switches come with a default Static IP address of **10.90.90.90**;
5. Configure your PC with a Static IP address in the same subnet such as 10.90.90.66, with subnet mask 255.0.0.0.
6. Open your Internet browser and type the default IP address of the switch: <http://10.90.90.90>. The default **Password** is “**admin**”.

20 ENABLING IGMP PROTOCOL

Internet Group Management Protocol (IGMP) is mandatory for the correct operation of VEO over IP products when they are configured as multicast devices. Without IGMP enabled, audio/video signal can't be transmitted properly or it may freeze.

With IGMP snooping, the Smart Managed Switch can make intelligent multicast forwarding decisions by examining the content of each frame's Layer 2 MAC header. IGMP snooping can help reduce cluttered traffic on the LAN. With IGMP snooping enabled, the Smart Managed Switch will forward multicast traffic only to connections that have group members attached.

7. Select **L2 Function**→**Multicast**→**IGMP Snooping**
8. Enable **IGMP Snooping** by activating the related selection box and clicking on **Apply**.

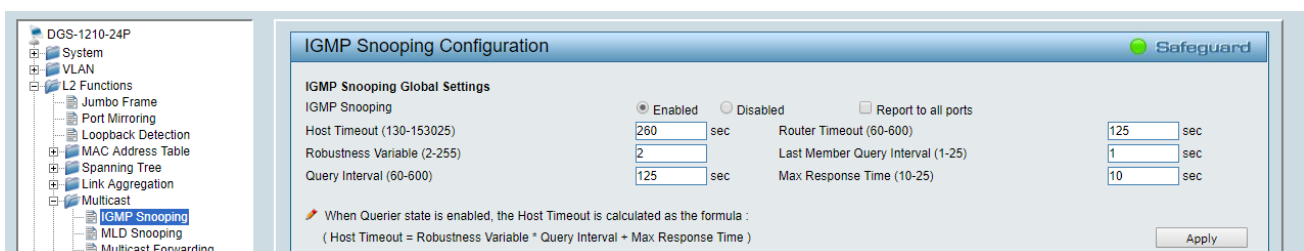

9. Select **Save** in the upper left corner and press **Save Config** button in order to ensure that all changes are saved as current configuration in use.

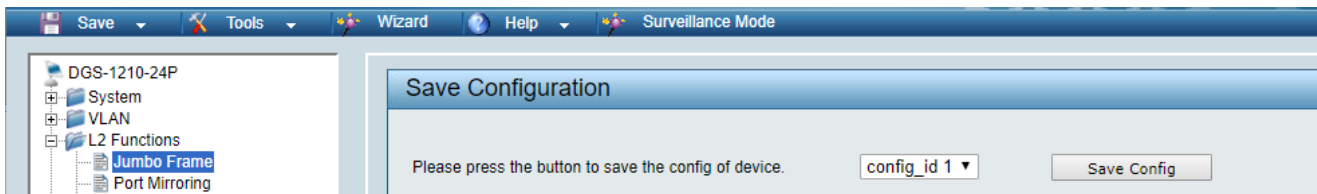

21 ENABLING Jumbo Frame

D-Link Gigabit Smart Managed Switches support jumbo frames (frames larger than the Ethernet frame size of 1536 bytes) of up to 9216 bytes (tagged). It is disabled by default.

2. Select **L2 Function**→ **Jumbo Frame**

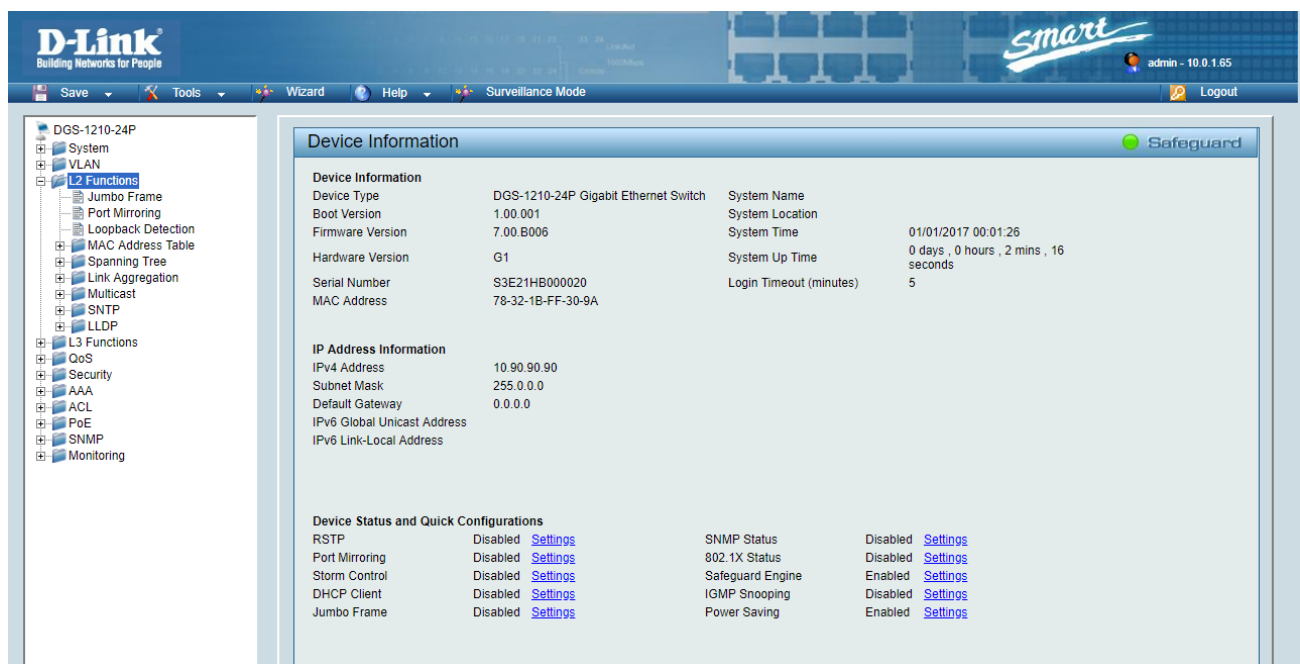

3. Enable **Jumbo Frame** by activating the related selection box and click on **Apply**.

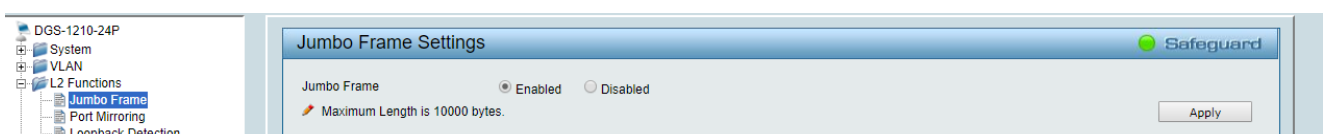

4. Select **Save** in the upper left corner and press **Save Config** button in order to ensure that all changes are saved as current configuration in use.

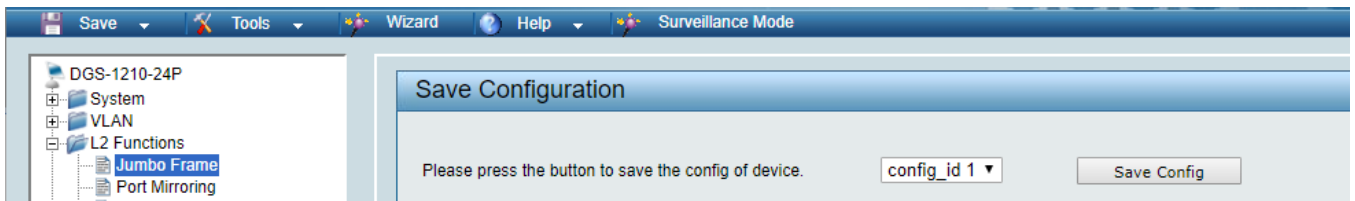

22 Disabling POWER Saving and EEE (Energy Efficient Ethernet)

In order to prevent audio or video drops out, all the power saving features need to be disabled. This is a mandatory requirement for Dante™ Networks.

1. Select **System** → **Power Saving**
2. On **Global Settings** disable Cable Length Detection/Link Status Detection and press **Apply**

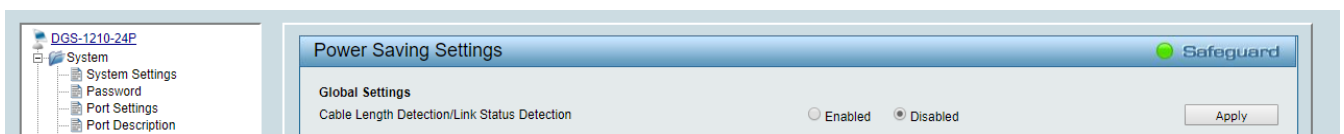

3. Select **IEEE802.3az EEE settings** and ensure that the feature is disabled on the ports where Dante or VEO devices are connected

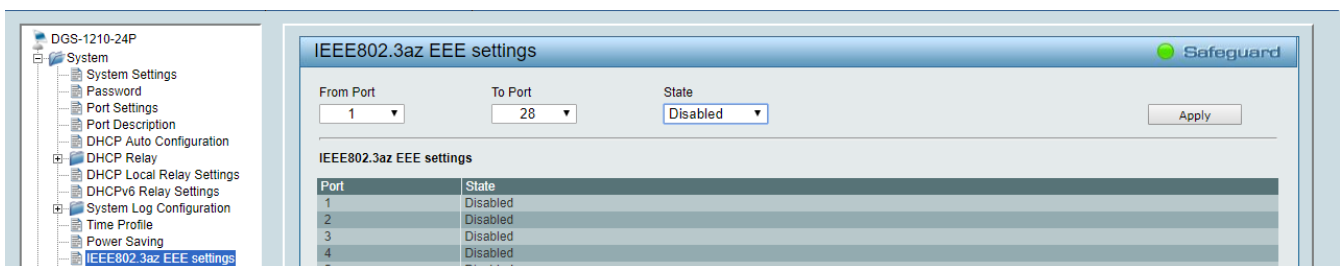

4. Select **Save** in the upper left corner and press **Save Config** button in order to ensure that all changes are saved as current configuration in use.

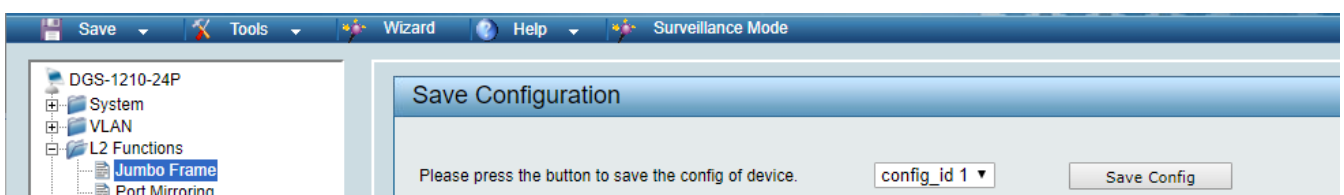

23 CREATING VLANs FOR DANTE™, VIDEO OVER IP AND CONTROL COEXISTENCE

In AV system where Dante™ and Video over IP traffic are sharing the same network switch, VLANs are highly recommended because Video over IP could interfere with Dante™ in the same network.

A VLAN allows isolating the network traffic of a predefined group of ports; in case of Audio and Video systems we need to create two VLANs: one for Audio and one for Video. In this case, a device connected to the Audio VLAN can't communicate with a device connected to the Video VLAN.

When a control device (like a touch panel) is required, it needs to communicate both with Audio and Video devices; in this case we need to use a particular feature called Asymmetric VLAN that allows sharing traffic between different VLANs only on predefined ports.

In the following example (Fig. 1) we have:

- **MIMO4040DN** matrix with Dante™ (Control on **port 1**; Dante on **port 2**)
- **WPNETTOUCH** (Control on **port 3**)
- **DN404BOB** (Dante/Control on **port 5**)
- **VEO-XTI2L** (Video/Control on **port 15**)
- **VEO-XRI2L** (Video/Control on **port 16**)
- **VEO-XRI2L** (Video/Control on **port 17**)

We need to create 2 VLANs like follows:

- 1 Audio/Control VLAN (default):
- 2 Video/Control VLAN:

- Ports 1-14
- Ports 15-28

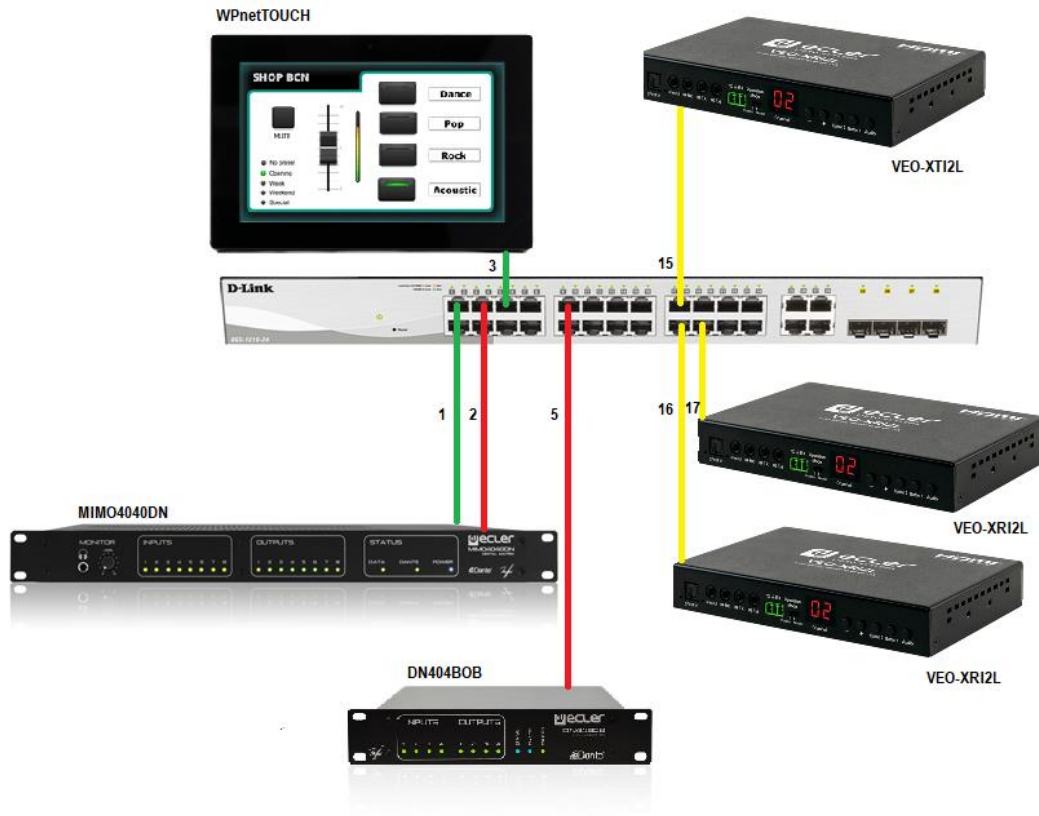
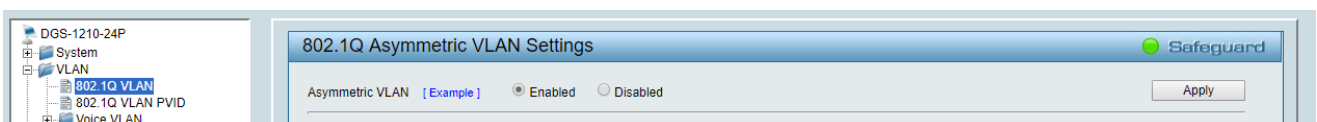
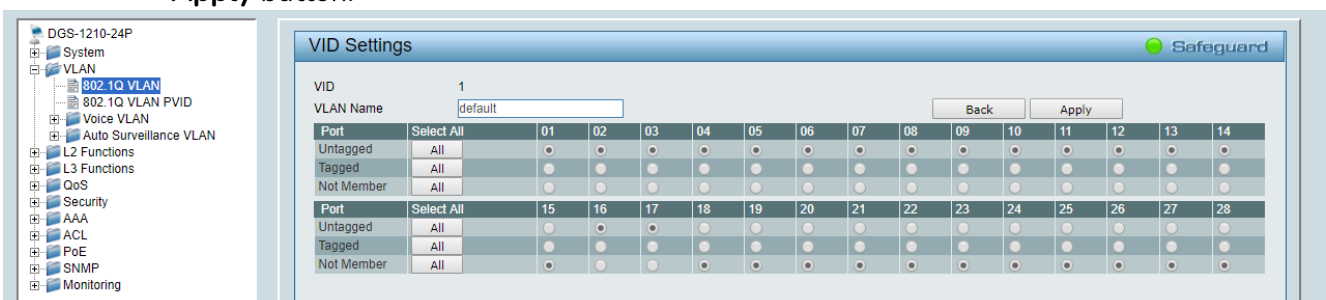

Fig. 1

- 5. Select VLAN→802.1Q VLAN, enable **Asymmetric VLAN** and click on **Apply**



- 6. Click on **1** and mark as Untagged all the Audio/Control VLAN ports (1-14), adding the Video/Control VLAN ports that need to share Control (16-17). Click on the **Apply** button.



7. Create a second VLAN for Video/Control by clicking on **Add** button

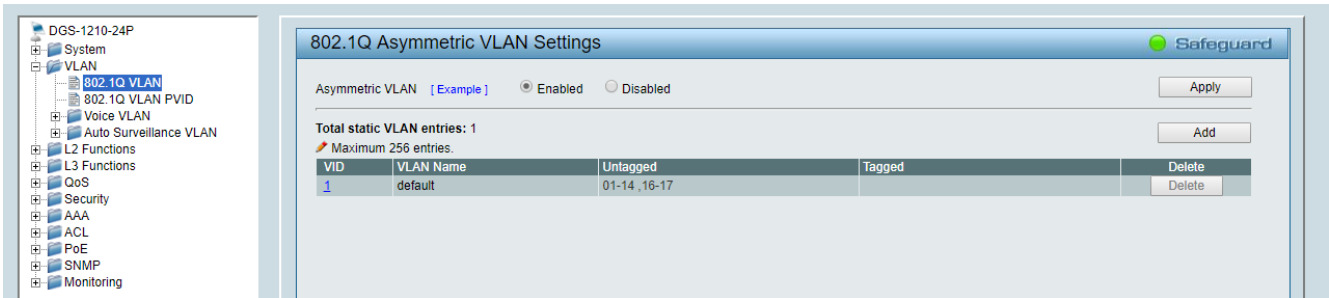

8. Assign 2 as VID, and Video as Name to the new VLAN; mark as Untagged all the Video/Control VLAN ports (15-28), adding the Audio/Control VLAN ports that need to share Control traffic (1-3). Click on the **Apply** button.

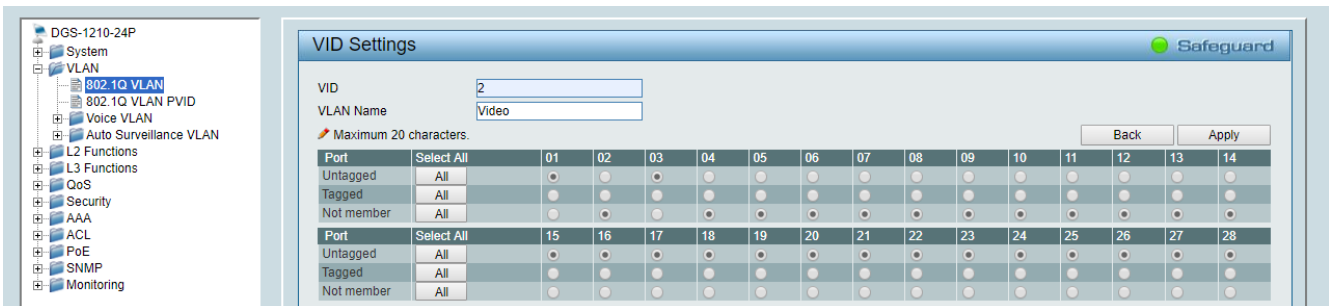

9. Select **Save** in the upper left corner and press **Save Config** button in order to ensure that all changes are saved as current configuration in use.

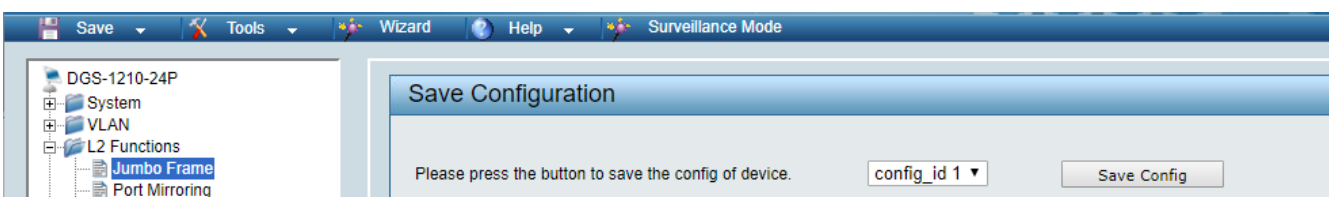



All product characteristics are subject to variation due to production tolerances. **NEEC AUDIO BARCELONA S.L.** reserves the right to make changes or improvements in the design or manufacturing that may affect these product specifications

For technical queries contact your supplier, distributor or complete the contact form on our website, in [Support / Technical requests](#).

Motors, 166-168 08038 Barcelona - Spain - (+34) 932238403 | information@ecler.com | www.ecler.com