

eMOTUS30D

COMMERCIAL LOUDSPEAKERS

Outdoor Loudspeaker



PRODUCT OVERVIEW

eMOTUS30D is a loudspeaker cabinet, 3" woofer with eMOTUS unique design. Ready for indoor and outdoor applications, thanks to its aluminium grill and UV protection treatment (IP65-rated). A professional and compact loudspeaker, cost-effective and with a unique design that will easily fit in a massive number of applications: theme parks, gardens, nature parks and urban spaces, leisure, health and sport centres, residential buildings, outdoor areas, etc. Available in black and white colour. Wall mount accessories and safety sling are included for an easy and secure installation.

KEY FEATURES

- 3" woofer
- 25WRMS @ 8Ω
- Power options:
 - 2.5W/5W/7.5W/15W @ 100V
 - 1.25W/2.5W/3.75W/7.5W @ 70V
- Max SPL (Peak) :105dB
- Outdoor design: IP65 rated
- Wall-bracket and adhesive legs for a desktop installation included.
- Ceiling or ground installation with optional accessories.
- Back rubber cover for connections
- Euroblock connection
- Available in black (RAL 9005) and white (RAL 9016) colour
- [EASE files available](#).



APPLICATIONS

- Retail
- Education
- Corporate
- Leisure
- Sports & Wellness
- Hospitality

TECHNICAL SPECIFICATIONS

eMOTUS3OD

System	
Effective frequency range ¹	120 Hz - 20 kHz (-10dB)
Coverage angle ²	196°x187° (HxV)
Power handling	25W RMS / 100W Peak
Sensitivity ³	85dB (1W/1m)
Maximum SPL ⁴	99dB continuous / 105dB peak
Power options	2.5W/5W/7.5W/15W @ 100V and 8Ω 1.25W/2.5W/3.75W/7.5W @ 70V and 8Ω
Recommended amplifier power	50W
Transducers	
Ways	1-way
Low frequency driver	3" woofer
Nominal impedance	8Ω
Physical	
Connection type	2-terminal Euroblock connector (Input)
Power type selector	Selectable transformer tap
Installation options	Surface (wall mount), desktop
Environmental	IP65 rated
Enclosure material	ABS plastic
Grille material	Aluminium
Mounting system	ABS bracket
Operating temperature	Min: -10°C; 14°F Max: 40°C; 104°F
Operating humidity	<85% HR
Storage temperature	Min: -10°C; 14°F Max: 40°C; 104°F
Storage humidity	<90% HR
Included accessories	Wall-mount bracket, adhesive legs, back rubber cover & security steel cable
Optional accessories	-
Finished colour	White (RAL 9016) or black (RAL 9005)
Dimensions (WxHxD)	132x134.5x115.5 mm / 5.20x5.30x4.55 in.
Weight	1.3 kg. / 2.87 lb.
Pieces per box	2

¹10dB below the sound pressure level at specified sensitivity

²6dB below the sound pressure level than that at the direction of maximum level. Max. angle between 1 kHz and 4 kHz.

³Measured on-axis, 2,83V, far field and referenced to 1 meter by inverse square law. Average from 100 Hz to 10 kHz.

⁴Calculated from sensitivity and power handling specifications, exclusive of power compression

FREQUENCY RESPONSE ON-AXIS

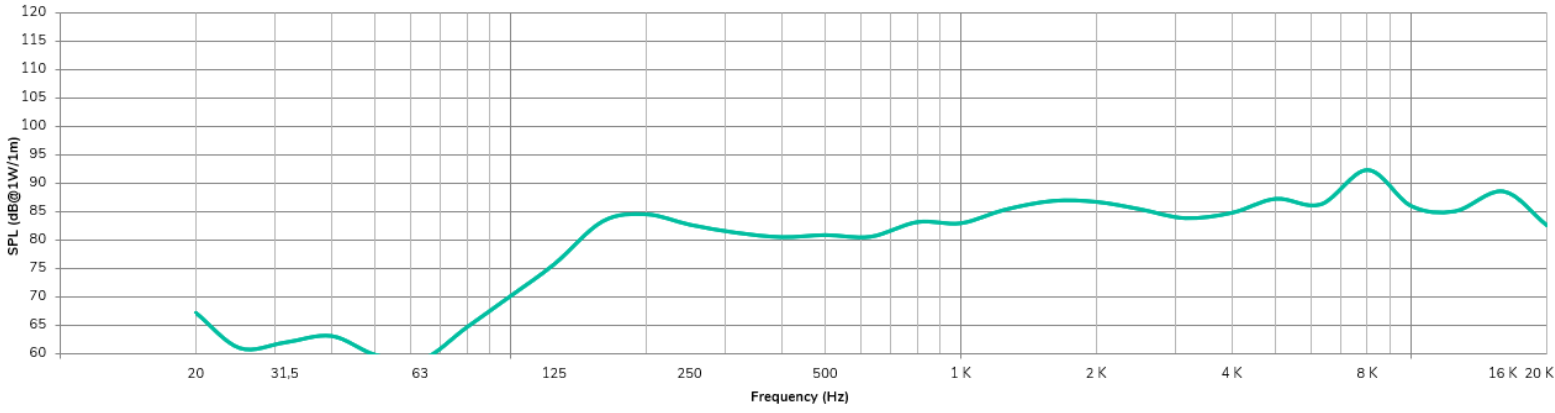

POLAR DIAGRAMS

HORIZONTAL

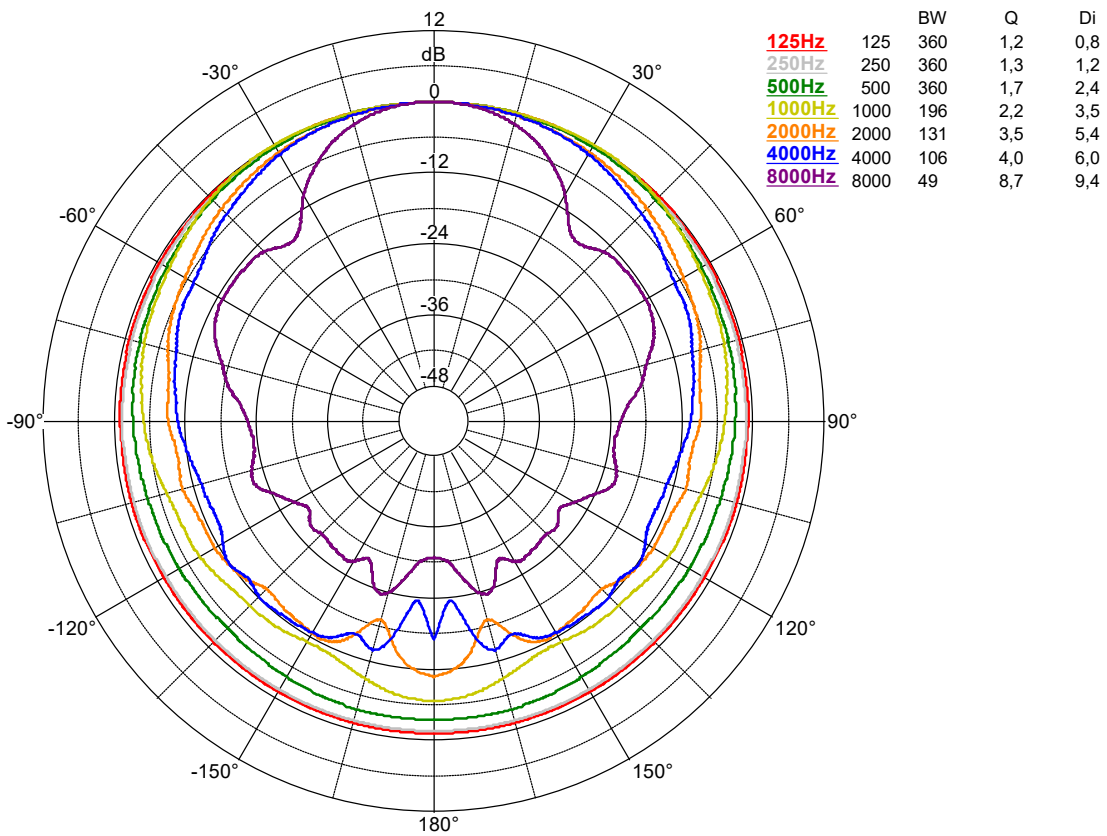

VERTICAL

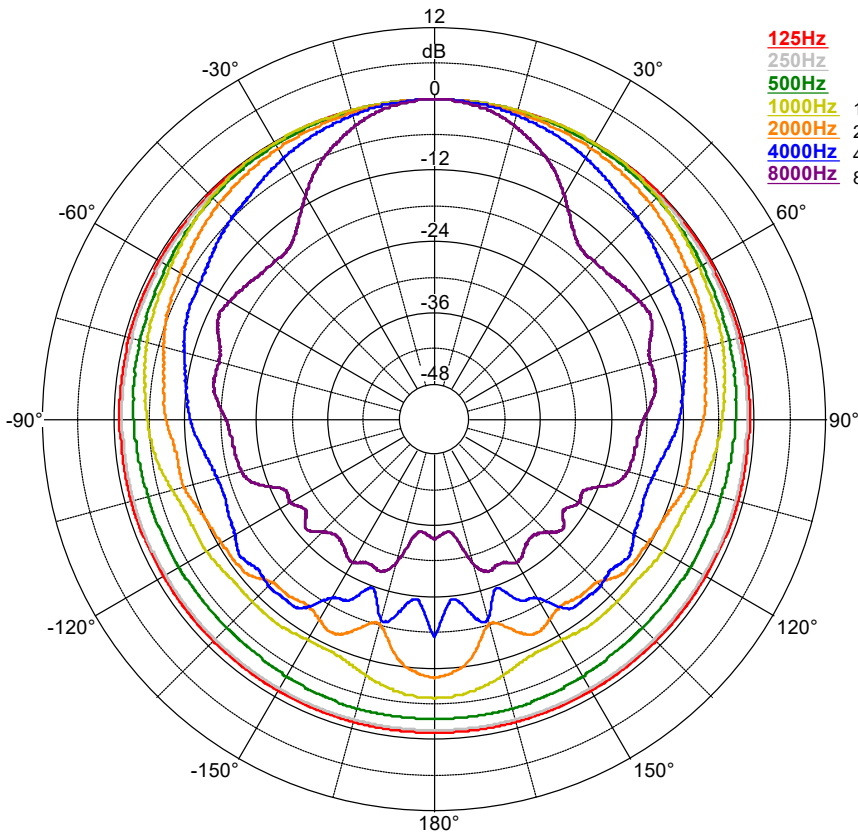

	BW	Q	Di
125Hz	125	360	1,2
250Hz	250	360	1,3
500Hz	500	360	1,7
1000Hz	1000	187	2,4
2000Hz	2000	143	3,3
4000Hz	4000	93	4,9
8000Hz	8000	46	9,6

MECHANICAL DIAGRAM



Ecler eMOTUS3OD Mechanical Diagram

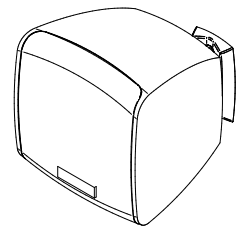
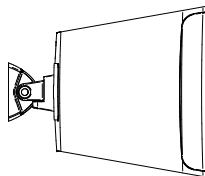
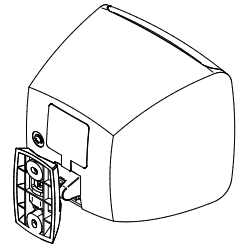
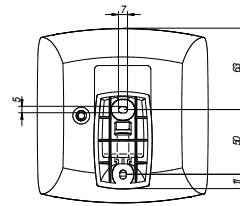
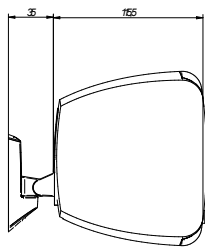
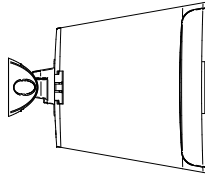
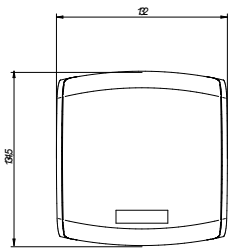

All the measurements are in mm

61-11129-0100

www.ecler.com

WALL BRACKET MOUNTING DIAGRAM

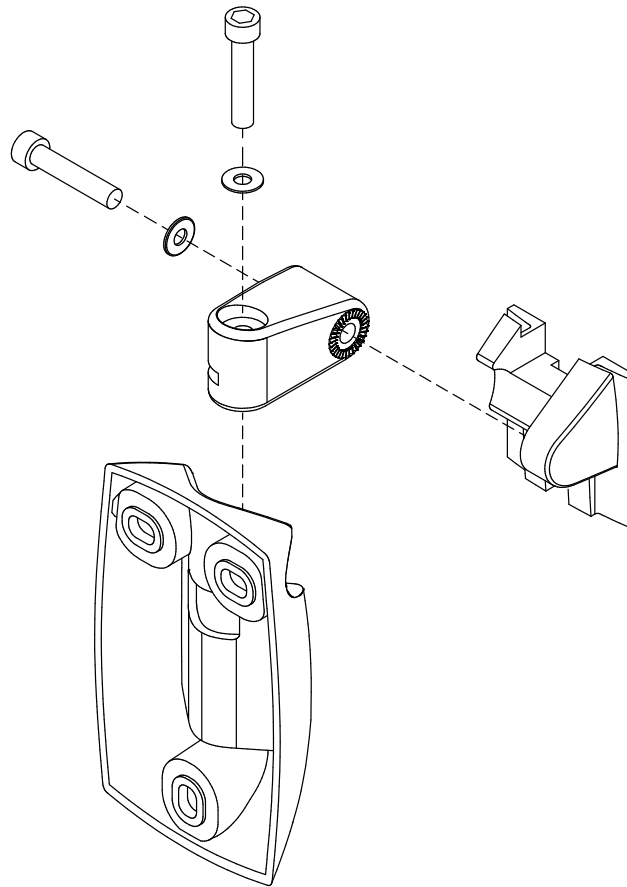

A&E SPECIFICATIONS

The loudspeaker shall be a wall-mount type consisting of a 3" woofer suitable for 70/100 V line or low impedance installations. The power handling should be 25 W RMS at a nominal impedance of 8 Ω with a peak power handling of 100 W. It shall include a multi-tapping line transformer with tapings 2.5W/5W/7.5W/15W @ 100V and 1.25W/2.5W/3.75W/7.5W @ 70V.

The effective frequency range (± 10 dB) shall be from 120 Hz to 20 kHz. The sensitivity shall be 85 dB considering 1 W input signal at 1 meter distance. The maximum continuous sound pressure level shall be 99 dB, while the maximum peak pressure level shall be 105 dB considering the loudspeaker's rated power. The coverage angle shall be 196°x187° (HxV) coverage pattern.

The enclosure shall be made of ABS plastic and the grill shall be made of rust-proof aluminium. It shall be IP65 rated for outdoors installation. It shall come available in both white (RAL9016) and black (RAL9005) colours. Connection shall be made via terminal block, including Wall-mount bracket, adhesive legs, back rubber, cover & security steel cable.

The loudspeaker shall have a width of 132 mm, a high of 134.5 mm and a depth of 115.5 mm. The weight shall not exceed 1,3 kg. It shall have data files available that can be used with EASE acoustic simulation software.

The loudspeaker shall be the ECLER eMOTUS30D.



All product characteristics are subject to variation due to production tolerances. **NEEC AUDIO BARCELONA S.L.** reserves the right to make changes or improvements in the design or manufacturing that may affect these product specifications.

For technical queries contact your supplier, distributor or complete the contact form on our website, in [Support / Technical requests](#).

Motors, 166-168 - 08038 Barcelona - Spain | Tel. (+34) 932238403 | information@ecler.com | www.ecler.com