

# THIA-2T / THIA-2R

VIDEO DISTRIBUTION OVER IP  
JPEG2000 4K over IP Video Extenders



## USER MANUAL



PRECAUTIONS
WARRANTY & ENVIRONMENT
PACKAGE CONTENTS
DESCRIPTION & FEATURES
INSTALL & CONNECT
START-UP & OPERATION
PANEL FUNCTIONS
TECHNICAL DATA

# TABLE OF CONTENTS

<b>1. PRECAUTIONS.....</b>	<b>4</b>
1.1 Important Notice.....	4
1.2 Key Safety Directions.....	5
1.3 Cleaning Directions.....	5
<b>2. WARRANTY &amp; ENVIRONMENT .....</b>	<b>6</b>
<b>3. PACKAGE CONTENTS.....</b>	<b>7</b>
3.1 THIA-2T .....	7
3.2 THIA-2R.....	7
<b>4. DESCRIPTION &amp; FEATURES .....</b>	<b>8</b>
4.1 Main Features.....	8
<b>5. INSTALL &amp; CONNECT.....</b>	<b>9</b>
5.1 6U Rack Mounting (THIA-RK).....	9
5.2 Network Requirements and Configuration.....	10
5.2.1 Setting the IP address .....	10
5.2.2 Video Distribution Quick Start .....	11
5.3 Mains Connection.....	12
5.3.1 Connection Diagram .....	13
<b>6. START-UP &amp; OPERATION.....</b>	<b>14</b>
6.1 Configuration Using Web Interface .....	14
6.2 THIA-2T Web Interface .....	14
6.2.1 System.....	14
6.2.2 Video Wall.....	15
6.2.3 Network.....	16
6.2.4 Functions.....	17
6.3 THIA-2R Web Interface.....	19
6.3.1 System.....	19
6.3.2 Video Wall.....	20
6.3.3 Network.....	21
6.3.4 Functions.....	22
6.4 Remote Controlling.....	24
6.4.1 Advanced Network Management.....	24
<b>7. PANEL FUNCTIONS.....</b>	<b>25</b>
7.1 THIA-2T.....	25
7.1.1 Front Panel.....	25
7.1.2 Rear Panel .....	26
7.2 THIA-2R.....	27

PRECAUTIONS
WARRANTY & ENVIRONMENT
PACKAGE CONTENTS
DESCRIPTION & FEATURES
INSTALL & CONNECT
START-UP & OPERATION
PANEL FUNCTIONS
TECHNICAL DATA

7.2.1 Front Panel.....	27
7.2.1 Rear Panel.....	28
7.3 IR Pin Definition.....	29
<b>8. TECHNICAL DATA .....</b>	<b>30</b>
8.1 Technical Specifications.....	30
8.1.1 THIA-2T.....	30
8.1.2 THIA-2R.....	32
8.2 Mechanical Diagram.....	34
8.2.1 THIA-2T.....	34
8.2.2 THIA-2R.....	35

PRECAUTIONS
WARRANTY & ENVIRONMENT
PACKAGE CONTENTS
DESCRIPTION & FEATURES
INSTALL & CONNECT
START-UP & OPERATION
PANEL FUNCTIONS
TECHNICAL DATA

# 1. PRECAUTIONS

## 1.1 Important Notice



**WARNING: SHOCK HAZARD - DO NOT OPEN**

**AVIS: RISQUE DE CHOC ÉLECTRIQUE - NE PAS OUVRIR**



The flashing light with an arrowhead symbol inside an equilateral triangle on it is intended to alert the user of the presence of non-insulated “dangerous voltage” within the enclosure, which might be of sufficient magnitude to pose a risk of electric shock to users.



The exclamation mark within an equilateral triangle is intended to alert the user of the requirement for important operating and maintenance (servicing), for which instructions may be found in the literature accompanying the appliance.

**WARNING (If applicable):** Terminals marked with symbol ⚡ may be of sufficient magnitude to pose a risk of electric shock. The external wiring connected to terminals requires installation by a technician, or the use of ready-made leads or cords.

**WARNING:** To prevent fire or shock hazard, do not expose this equipment to rain or humidity.

**WARNING:** A device with Class I manufacturing ought to be connected to a mains socket outlet with a protective earthing connection.



**WARNING:** Ecler products have a long lifetime of more than 10 years. This product must never be discarded as unsorted urban waste, but must be taken to the nearest electrical and electronic waste treatment centre.



**This equipment has been tested and found to comply with the limits of a Class A digital device, pursuant to part 15 of the FCC Rules.** Such limits are designed to provide reasonable protection against harmful interference when the equipment is operated in a commercial environment. This equipment generates, uses and can radiate radio frequency energy and, if not installed and used in accordance with the instruction manual, may cause harmful interference in radio communications. Operation of this equipment in a residential area might cause harmful interference, in which case, the user will be required to correct the interference at his own expense.



PRECAUTIONS

WARRANTY & ENVIRONMENT

PACKAGE CONTENTS

DESCRIPTION & FEATURES

INSTALL & CONNECT

START-UP & OPERATION

PANEL FUNCTIONS

TECHNICAL DATA

## 1.2 Key Safety Directions

1. Read the following directions.
2. Keep the following directions.
3. Observe all warnings.
4. Follow all instructions.
5. Do not use this device in proximity to water.
6. Clean only with a dry cloth.
7. Do not block any ventilation openings. Install in accordance with the manufacturer's instructions.
8. Do not install near any heat sources such as radiators, heat registers, stoves, or other devices (including amplifiers) that may release heat.
9. Do not defeat the safety purpose of the polarized or grounding type plug. A polarized plug has two blades, with one being wider than the other. A grounding type plug has two blades and a third grounding prong. The wide blade or the third prong are provided for your safety. If the provided plug does not fit into your outlet, contact a qualified electrician for a replacement of the obsolete outlet.
10. Protect the power cord from being walked on or pinched, particularly at the plugs, convenience receptacles, and at the point of exit from the device.
11. Only use attachments/accessories specified by the manufacturer.
12. Unplug the device during lightning storms or when unused for long periods.
13. Refer all servicing to qualified personnel. Servicing is required when the device has been damaged in any way, such as power supply cord or plug damage, liquid spillage or objects onto the device, the device has been exposed to rain or humidity, does not operate normally, or has been dropped.
14. Disconnecting from mains: When switching off the POWER switch, all the functions and light indicators of the unit will be stopped, but fully disconnecting the device from mains is done by unplugging the power cable from the mains input socket, therefore, it should always remain easily accessible
15. Equipment is connected to a socket-outlet with an earthing connection by means of a power cord.
16. The marking information is located at the top, rear or bottom of the unit.
17. The device shall not be exposed to dripping or splashing liquids, and no liquid-filled objects, such as a filled up glass, shall be placed on top of the device.

## 1.3 Cleaning Directions



**Clean the unit with a soft, dry clean cloth** or slightly wet with water and neutral liquid soap only, then dry it with a clean cloth. Be careful that water never gets into the unit through any hole. Never use alcohol, benzine, solvents or abrasive substances to clean this unit.

**NEEC AUDIO BARCELONA, S.L.** accepts no liability for any damage that may be caused to people, animal, or objects due to failure to comply with the warnings above.



PRECAUTIONS

WARRANTY & ENVIRONMENT

PACKAGE CONTENTS

DESCRIPTION & FEATURES

INSTALL & CONNECT

START-UP & OPERATION

PANEL FUNCTIONS

TECHNICAL DATA

## 2. WARRANTY & ENVIRONMENT

**Thank you for choosing our Ecler THIA-2T and THIA-2R !  
We greatly value your trust.**

It is **VERY IMPORTANT** to carefully read this manual and to fully understand its contents before any connecting takes place in order to make the best use of this equipment, as well as to get the best performance from it.

To ensure optimal operation of this device, **we strongly recommend that its maintenance be carried out by our authorised Technical Services.**

**All ECLER products are covered by warranty**, please refer to [www.ecler.com](http://www.ecler.com) or the warranty card included with this product for the period of validity and conditions.



**Ecler is truly committed with the environment and planet sustainability, energy saving and CO<sub>2</sub> emission reduction.** Recycling materials and using non-contaminant components are also top priorities in our green crusade.

**Ecler has deeply evaluated and analyzed the environmental impacts of all the processes involved in the production of this product, including packaging, and has alleviated, reduced and/or compensated for them.**



PRECAUTIONS

WARRANTY  
&  
ENVIRONMENT

PACKAGE  
CONTENTS

DESCRIPTION  
&  
FEATURES

INSTALL  
&  
CONNECT

START-UP  
&  
OPERATION

PANEL  
FUNCTIONS

TECHNICAL  
DATA

## 3. PACKAGE CONTENTS

### 3.1 THIA-2T

- 1x THIA-2T.
- 1x IR Receiver cable (1.5 metres).
- 1x IR Blaster cable (1.5 metres).
- 2 x 3-pin Euroblock connector (Green colour).
- 1 x 3-pin Euroblock connector (Blue colour).
- 2 Mounting ears.
- 4 x Mounting screws.
- 1 x PSU 12V/1A.
- 1x First Steps Guide.
- 1x Warranty card.

### 3.2 THIA-2R

- 1x THIA-2R.
- 1x IR Receiver cable (1.5 metres).
- 1x IR Blaster cable (1.5 metres).
- 2 x 3-pin Euroblock connector (Green colour).
- 2 Mounting ears.
- 4 x Mounting screws.
- 1 x PSU 12V/1A.
- 1x First Steps Guide.
- 1x Warranty card.



PRECAUTIONS

WARRANTY & ENVIRONMENT

PACKAGE CONTENTS

DESCRIPTION & FEATURES

INSTALL & CONNECT

START-UP & OPERATION

PANEL FUNCTIONS

TECHNICAL DATA

## 4. DESCRIPTION & FEATURES

**THIA-2T transmitter and THIA-2R receiver** are a 4K 30 Hz Video-over-IP system based on JPEG2000 compression that enables secure, low-latency distribution of HDMI® signals. Designed for easy integration into professional AV networks, they provide advanced control capabilities through their dedicated controller and facilitate interoperability with a wide range of video systems in content distribution and management environments.

### 4.1 Main Features

- Video over IP Unicast and Multicast distribution over 1Gb managed networks.
- Support for JPEG2000 video codec with 1-2 frame latency.
- Support for HDMI® 18Gbps 4K 60Hz 4:4:4 as specified in HDMI® 2.0b input.
- Support for HDMI® 18Gbps 4K 30Hz 4:4:4 as specified in HDMI® 2.0b output.
- Transmission distance up to 100 meters over Cat 6 or higher cable.
- Support for Main and Sub stream for video preview.
- Support for video wall compositing and management up to 9 x 9 setups (via a compatible controller).
- Support for HDR10, HDR10+, Dolby Vision.
- Support for audio formats LPCM 2.0/5.1/7.1CH, Dolby Digital/Plus/EX, Dolby True HD, Dolby Atmos, DTS, DTS-96/24, DTS-EX DSD, DTS High Res, DTS-HD Master, DTS:X.
- Advanced EDID Management (via VEO-XCTRL4D, using THIA-2C Firmware version installed).
- HDCP 2.2 compliant.
- Stereo unbalanced analogue for audio insertion and extraction via Euroblock connectors.
- Includes HDMI® Loop Out on THIA-2T.
- USB 2.0/KVM, CEC, RS-232, IR pass-through.
- Control options include RS-232 (in development), SSH control, and WebGUI.
- Support for PoE function.



PRECAUTIONS

WARRANTY & ENVIRONMENT

PACKAGE CONTENTS

DESCRIPTION & FEATURES

INSTALL & CONNECT

START-UP & OPERATION

PANEL FUNCTIONS

TECHNICAL DATA

## 5. INSTALL & CONNECT

### 5.1 6U Rack Mounting (THIA-RK)

This product is compatible with the standard 6U rack, model THIA-RK (sold separately). For more information or assistance, please contact your dealer or visit [www.ecler.com](http://www.ecler.com).

1

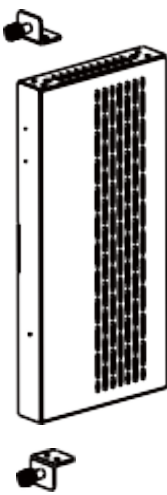

Secure the two supplied mounting ears to each side of the unit using the included screws. Ensure the ears are firmly fixed for stable rack installation.

2

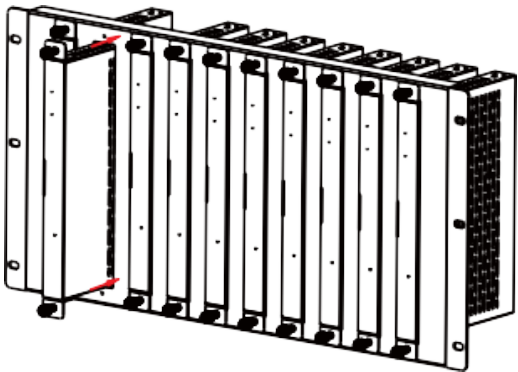

Carefully insert the unit -with mounting ears attached- into the designated slot in the 6U rack (up to 10 units can be installed vertically in a single rack).

3

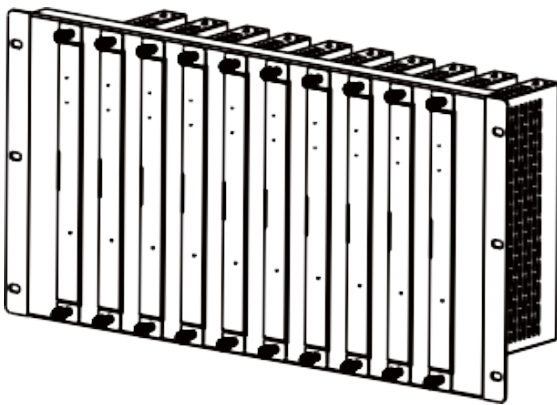

Tighten the captive screws to secure the mounting ears to the rack. Ensure the unit is properly installed and firmly secured.



PRECAUTIONS

WARRANTY & ENVIRONMENT

PACKAGE CONTENTS

DESCRIPTION & FEATURES

INSTALL & CONNECT

START-UP & OPERATION

PANEL FUNCTIONS

TECHNICAL DATA

## 5.2 Network Requirements and Configuration

THIA-2T and THIA-2R are not limited to certain brands of network hardware. However, the **network must support the following network features:**

- Layer 2 managed network switch or later.
- Jumbo Frame / MTU management.
- IGMP snooping support.

**!** To prevent malfunctioning, interference or drop in signal performance due to other network products bandwidth requirements or network design. It is highly recommended to check with the chosen network IT staff how to properly set the Multicast products connected to the local network switch.

### 5.2.1 Setting the IP address

The default IP address is set to Auto IP, using the 169.254.10.x range for transmitters and the 169.254.20.x range for receivers. It can also be assigned dynamically by a VEO-XCTRL4D controller if a unit with THIA-2C firmware is present on the network. For further details please refer to VEO-XCTRL4D controller module user manual.

**💡** The IP address can be changed using the embedded web page of a transmitter or a receiver. Both the network configuration of PC and THIA devices must be in the same network domain in order to be able to access its web settings page through an internet browser. For further details, refer to Configuration using Web interface section.

**!** When static IP addresses are required, the IP address of each device needs to be set manually.

**!** Set the PC's IP address to be 169.254.100.100, and the Subnet mask to be 255.255.0.0.

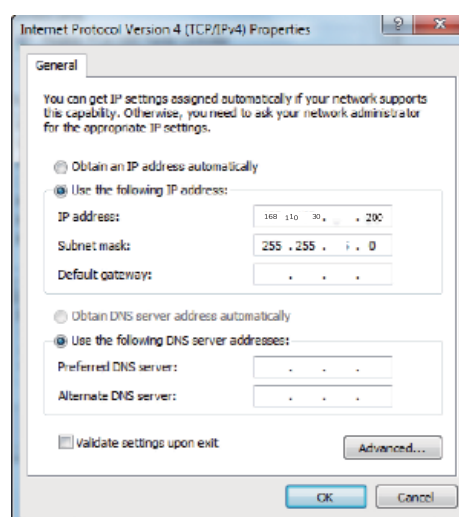
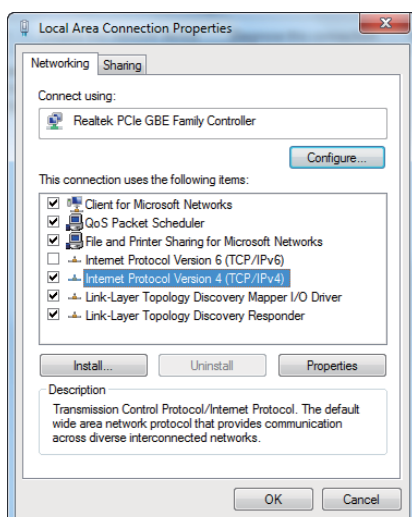

## 5.2.2 Video Distribution Quick Start

To begin a video transmission, a matching between a transmitter and a receiver is required. Each THIA-2T transmitter can stream a video signal over the network using an ID channel number that must be unique in the same network. Each ID channel from 0 to 762 identifies an IP address and every THIA-2R receiver can select one of these channels in order to receive an AV stream.

The ID channel for transmitters is usually set once during the setting up of the system while the receivers ID usually are the ones that are modified to show different content on the displays. The destination receiver ID must be set in the same channel as the transmitter broadcasting the desired source audio and video content.

The ID channel can be selected in four different ways:

- Via the Web Page configuration on the same device.
- Via the Web Page configuration on a compatible controller unit.
- Via RS-232.
- Via TCP, and Telnet using a compatible controller unit.



PRECAUTIONS

WARRANTY  
&  
ENVIRONMENT

PACKAGE  
CONTENTS

DESCRIPTION  
&  
FEATURES

INSTALL  
&  
CONNECT

START-UP  
&  
OPERATION

PANEL  
FUNCTIONS

TECHNICAL  
DATA

### 5.3 Mains Connection

#### 1. Connecting the Transmitter (THIA-2T) and Receiver (THIA-2R) via Power over Ethernet (PoE)

Use a Cat6 or higher category cable to interconnect the transmitter with the receiver or connect each device to the LAN port of your network switch if this one support PoE.

#### 2. Local Power Source

- a) Both devices are supplied with an external power supply: 100-240 VAC and 50-60 Hz. This external power supply includes interchangeable socket adapters for use in different regions worldwide, as shown below:



- b) Once transmitter and receiver are connected via PoE, connect the power supply with the appropriate regional connector to either the transmitter or the receiver, and plug it into the AC mains.

 To avoid buzzing, do not allow the power cable to intertwine with audio shielded cables.

	PRECAUTIONS
	WARRANTY & ENVIRONMENT
	PACKAGE CONTENTS
	DESCRIPTION & FEATURES
	INSTALL & CONNECT
	START-UP & OPERATION
	PANEL FUNCTIONS
	TECHNICAL DATA

### 5.3.1 Connection Diagram

When THIA-2T and THIA-2R devices are connected in a point to point or point to multipoint or multipoint to multipoint topology, every transmitter and receiver should have a unique IP address. When possible, it is recommended to create an independent IP video network using managed network switches. Use of gigabit switches with an IGMP Snooping support will create the most appropriate scenario. For application examples check the Examples section.

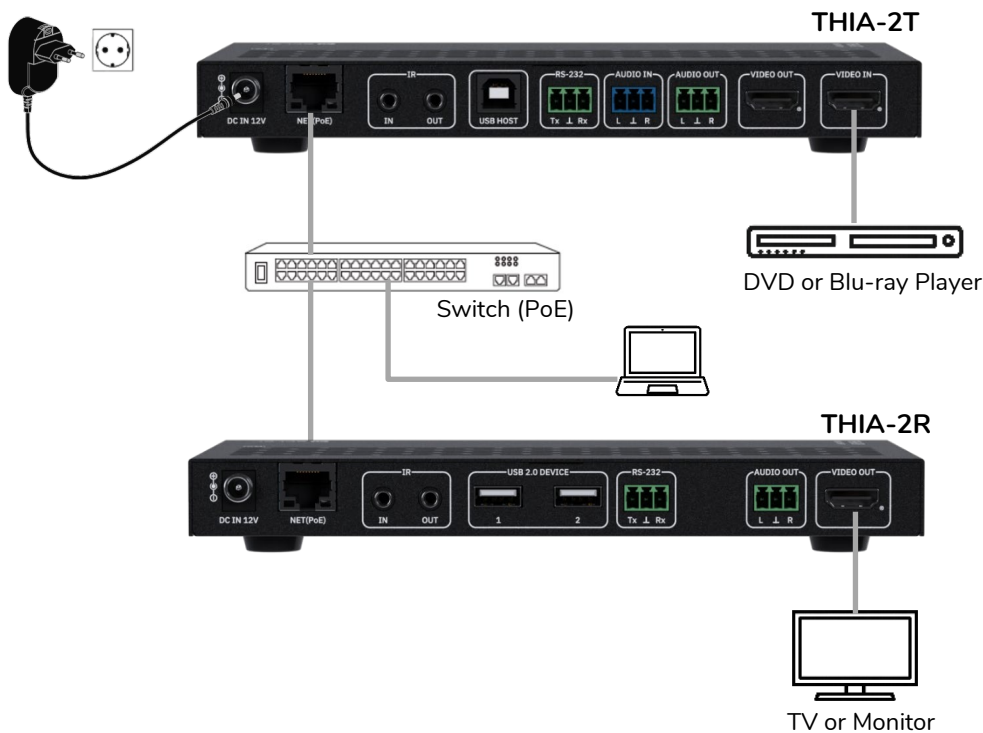

**!** When the Network Switch does not support PoE, then the THIA-2T, THIA-2R and the optional VEO-XCTRL4D compatible controller module with THIA-2C firmware installed should be powered using the included DC power adapter.

1. Connect the source devices to the HDMI® ports of the THIA-2T transmitters.
2. Connect the HDMI® endpoints to the HDMI® ports of the THIA-2R receivers.
3. Connect Audio IN/OUT to a sound device and select the required audio mode.
4. Connect all THIA devices to the network switch using Cat 6 or higher cables.
5. (optional) Power THIA-2T transmitter and THIA-2R receiver with the included power adapter and power the switch. In case the switch supports PoE (Power over Ethernet), it will not be necessary to power the THIA devices locally.

PRECAUTIONS
WARRANTY & ENVIRONMENT
PACKAGE CONTENTS
DESCRIPTION & FEATURES
INSTALL & CONNECT
START-UP & OPERATION
PANEL FUNCTIONS
TECHNICAL DATA

## 6. START-UP & OPERATION

### 6.1 Configuration Using Web Interface

THIA-2T and THIA-2R devices can be configured through their own built-in web interface by simply typing the IP address of the chosen device into a web browser. Refer to **Setting the IP address** section for further details on how to find the IP address of a THIA-2T and THIA-2R.

### 6.2 THIA-2T Web Interface

#### 6.2.1 System

The System page displays the version information for the THIA-2T firmware.

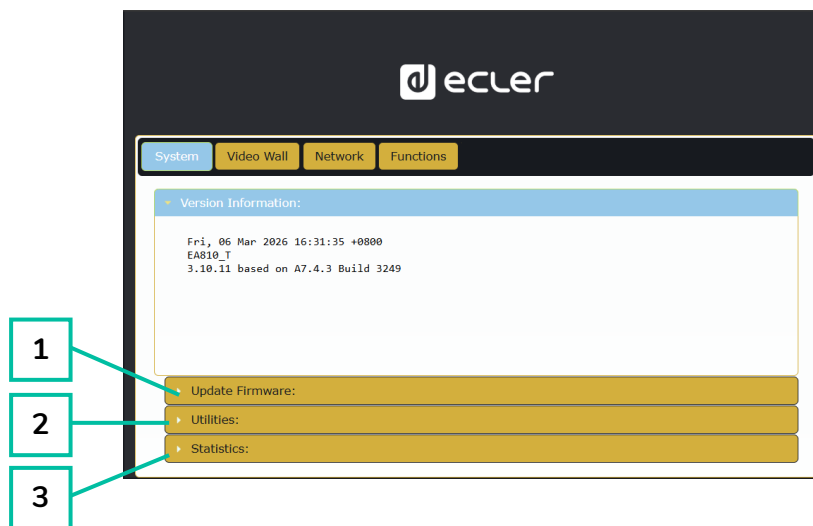

1. **Update Firmware:** allows to upload a file for firmware update of the device.
2. **Utilities:** this section provides basic system maintenance tools:
  - **Factory Default:** restores the device to its original factory settings.
  - **Reboot:** restarts the device without affecting configuration.
  - **Reset EDID to Default Value:** allows selection of the default EDID (HDMI, DVI, or VGA) to be applied.
  - **Console API Command:** enables the user to send manual API commands directly to the device. The output result is shown below the input field.
3. **Statistics:** this section provides real-time system information and diagnostics.
  - **State Machine:** indicates the current system state.
  - **Network:** displays hostname, IP address, subnet mask, gateway, MAC address, casting mode, and link status/speed.
  - **Video:** shows the active EDID in use, local video output status, and detailed video timing parameters such as resolution, refresh rate, scan mode, colour depth, HDR, HDCP, and capture windows.



PRECAUTIONS

WARRANTY  
&  
ENVIRONMENT

PACKAGE  
CONTENTS

DESCRIPTION  
&  
FEATURES

INSTALL  
&  
CONNECT

START-UP  
&  
OPERATION

PANEL  
FUNCTIONS

TECHNICAL  
DATA

## 6.2.2 Video Wall

This section **provides tools for creating and customizing multi-screen layouts**. It enables users to configure display alignment, monitor positions, and advanced scaling options for seamless video wall performance.

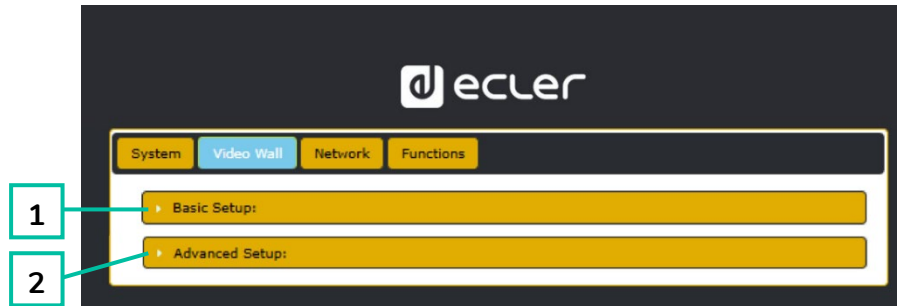

1. **Basic setup:** This section allows configuration of the video wall layout and visual alignment.
  - **Bezel and Gap Compensation:** Adjusts bezel width (OW, OH) and viewable area (VW, VH) in 0.1 mm units to correct display gaps.
  - **Wall Size and Position Layout:** Defines the number of monitors in the video wall (horizontal and vertical) and assigns the current unit's position (row and column) within the layout.
  - **Preferences:**
    - **Stretch Type:** Selects how the image fits the screen (e.g. Fit In, Fill).
    - **Rotate and Flip:** Adjusts screen orientation (0°, 90°, 180°, 270°).
    - **Apply To:** Applies the settings to one or multiple devices.
    - **Show OSD:** Enables on-screen display indicators for layout assistance.
  
2. **Advanced setup:** This section allows fine-tuning of individual screen positions and scaling within a video wall layout.
  - **Step 1 – Choose Control Target:** Assign the transmitter linked to a specific panel to configure within the wall matrix. Navigation arrows and the preview box help identify the selected unit.
  - **Step 2 – Control Options:**
    - **Reset to Basic Setup:** Restores the current panel's layout to the default configuration.
    - **Stretch Type & Rotation:** Adjusts image fitting and screen rotation.
    - **Screen Layout:** Defines the total size of the video wall (rows × columns).
    - **Row/Column Position:** Sets the current screen's position in the layout.
    - **Horizontal / Vertical Shift:** Fine-adjusts panel alignment in pixels.
    - **Horizontal / Vertical Scale Up:** Scales the image size proportionally per panel.
    - **Console API Command:** Allows manual input of control commands for advanced configuration.



PRECAUTIONS

WARRANTY  
&  
ENVIRONMENT

PACKAGE  
CONTENTS

DESCRIPTION  
&  
FEATURES

INSTALL  
&  
CONNECT

START-UP  
&  
OPERATION

PANEL  
FUNCTIONS

TECHNICAL  
DATA

## 6.2.3 Network

This interface allows users to configure the device's IP settings and select the casting mode (Multicast or Unicast).

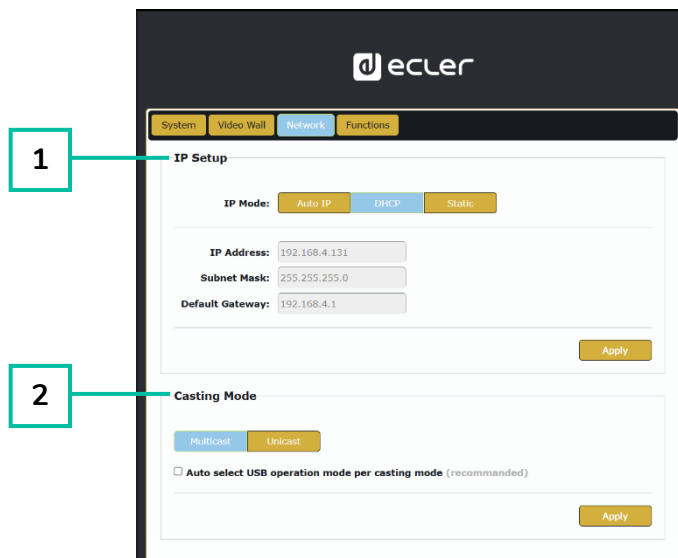

### 1. Three IP modes are available:

- A. **Auto IP:** The IP address is assigned automatically. A new address is randomly generated each time the device is powered off and restarted.
- B. **DHCP:** The IP address is assigned dynamically by a DHCP server (e.g. a router).
- C. **Static:** A fixed IP address manually assigned by the user.

### 2. Casting Mode: This section allows users to select how the video stream is distributed over the network.

- D. **Multicast:** The device sends the stream to multiple receivers simultaneously using a single transmission. This is efficient for large-scale distribution and minimizes bandwidth usage.
- E. **Unicast:** The device sends a separate stream to each receiver. This mode is suitable for direct one-to-one connections but consumes more bandwidth when multiple receivers are connected.
- F. **Auto Select USB Mode per Casting Mode:** When this option is enabled, it automatically adjusts the USB operation mode based on the selected casting mode.



**It is recommended to keep this option enabled for optimal performance.**



PRECAUTIONS

WARRANTY  
&  
ENVIRONMENT

PACKAGE  
CONTENTS

DESCRIPTION  
&  
FEATURES

INSTALL  
&  
CONNECT

START-UP  
&  
OPERATION

PANEL  
FUNCTIONS

TECHNICAL  
DATA

## 6.2.4 Functions

This section allows users to activate and configure key data transmission features over IP, including video, USB, and serial signals. These settings enable flexible and optimized device communication within a networked environment.

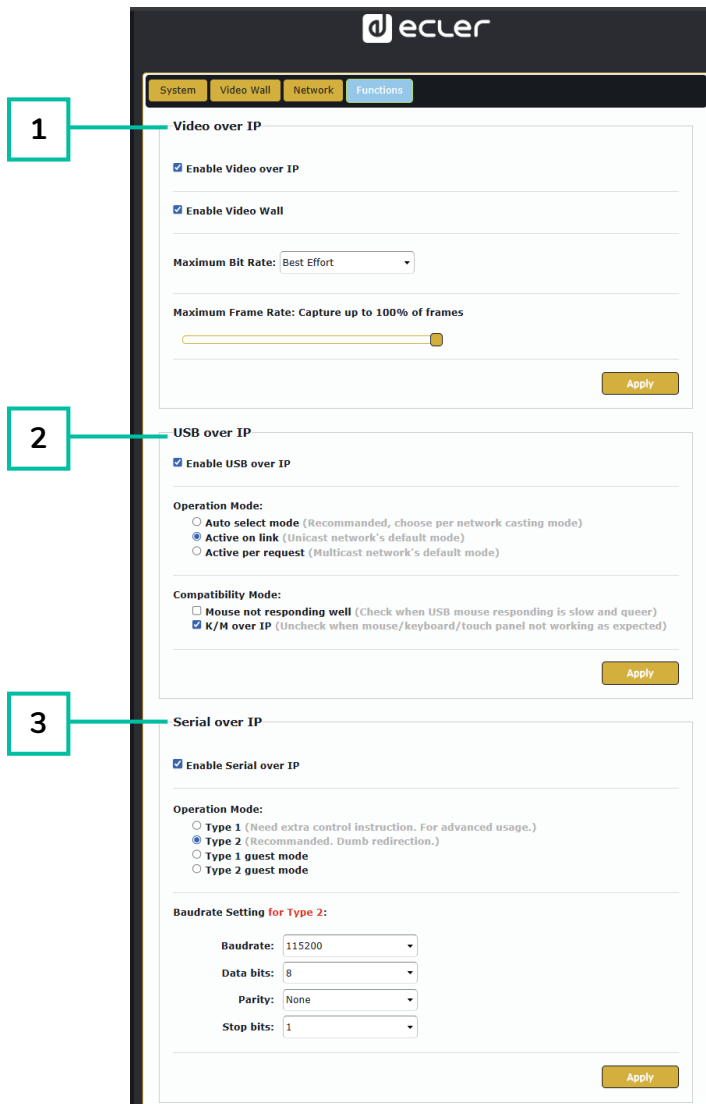

- 1. Video over IP:** This section enables video transmission over the network and allows users to define the maximum streaming bitrate.
  - **Enable Video over IP:** Activates video signal delivery over IP.
  - **Maximum Bit Rate:** Limits the bandwidth used for video streaming. Options include:
    - **Best Effort:** The device automatically adapts the bitrate based on current network conditions.
    - **500 / 400 / 300 / 200 Mbps:** Fixed bitrate values to match network capacity and performance requirements.



PRECAUTIONS

WARRANTY  
&  
ENVIRONMENT

PACKAGE  
CONTENTS

DESCRIPTION  
&  
FEATURES

INSTALL  
&  
CONNECT

START-UP  
&  
OPERATION

PANEL  
FUNCTIONS

TECHNICAL  
DATA

2. **USB over IP:** This section enables the transmission of USB signals over the network, allowing remote control of connected devices such as a mouse, keyboard or touch panel.

- **Enable USB over IP:** Activates the USB-over-IP functionality.
- **Operation Mode:**
  - **Auto select mode:** Recommended. Automatically adapts to the network casting mode (Unicast or Multicast).
  - **Active on link:** USB becomes active when a network link is established (default for Unicast).
  - **Active per request:** USB becomes active only when manually requested (default for Multicast).
- **Compatibility Mode:**
  - **Mouse not responding well:** Use when USB mouse response is laggy or unstable.
  - **K/M over IP:** Enables keyboard and mouse transmission over IP. Uncheck if input devices fail to respond properly.

3. **Serial over IP:** This section allows serial communication to be transmitted over the network, typically used for remote device control via RS-232 (in development phase).

- **Enable Serial over IP:** Activates serial-over-IP functionality.
- **Operation Mode:**
  - **Type 1:** Requires specific control instructions. Intended for advanced users.
  - **Type 2:** Recommended mode. Simple redirection of serial data without processing.
  - **Type 1 guest mode / Type 2 guest mode:** Variants of the above for specific device configurations.
- **Baudrate Settings for Type 2:**
  - **Baudrate:** Transmission speed (e.g., 115200 bps).
  - **Data bits:** Number of data bits per character (typically 8).
  - **Parity:** Error checking method (None, Even, Odd).
  - **Stop bits:** End of transmission bit (1 or 2).



PRECAUTIONS

WARRANTY & ENVIRONMENT

PACKAGE CONTENTS

DESCRIPTION & FEATURES

INSTALL & CONNECT

START-UP & OPERATION

PANEL FUNCTIONS

TECHNICAL DATA

## 6.3 THIA-2R Web Interface

### 6.3.1 System

The System page displays the version information for the THIA-2R firmware.

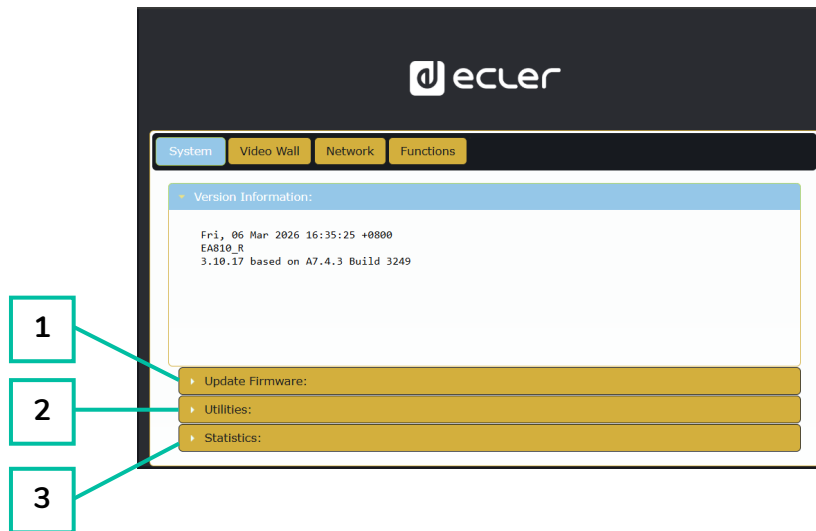

1. **Update Firmware:** allows to upload a file for firmware update of the device.
2. **Utilities:** this section provides basic system maintenance tools:
  - **Factory Default:** restores the device to its original factory settings.
  - **Reboot:** restarts the device without affecting configuration.
  - **Console API Command:** enables the user to send manual API commands directly to the device. The output result is shown below the input field.
3. **Statistics:** this section provides real-time system information and diagnostics.
  - **State Machine:** indicates the current system state.
  - **Network:** displays hostname, IP address, subnet mask, gateway, MAC address, casting mode, and link status/speed.
  - **Video:** Shows the local video output status, and detailed video timing parameters such as resolution, refresh rate, scan mode, colour depth, HDR, HDCP, and capture windows.



PRECAUTIONS

WARRANTY  
&  
ENVIRONMENT

PACKAGE  
CONTENTS

DESCRIPTION  
&  
FEATURES

INSTALL  
&  
CONNECT

START-UP  
&  
OPERATION

PANEL  
FUNCTIONS

TECHNICAL  
DATA

### 6.3.2 Video Wall

This section **provides tools for creating and customizing multi-screen layouts**. It enables users to configure display alignment, monitor positions, and advanced scaling options for seamless video wall performance.

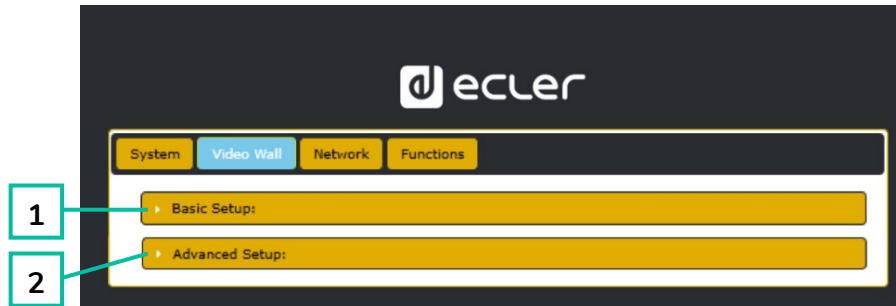

1. **Basic setup:** This section allows configuration of the video wall layout and visual alignment.
  - **Bezel and Gap Compensation:** Adjusts bezel width (OW, OH) and viewable area (VW, VH) in 0.1 mm units to correct display gaps.
  - **Wall Size and Position Layout:** Defines the number of monitors in the video wall (horizontal and vertical) and assigns the current unit's position (row and column) within the layout.
  - **Preferences:**
    - **Stretch Type:** Selects how the image fits the screen (e.g. Fit In, Fill).
    - **Rotate and Flip:** Adjusts screen orientation (0°, 90°, 180°, 270°).
    - **Apply To:** Applies the settings to one or multiple devices.
    - **Show OSD:** Enables on-screen display indicators for layout assistance.
  
2. **Advanced setup:** This section allows fine-tuning of individual screen positions and scaling within a video wall layout.
  - **Step 1 – Choose Control Target:** Selects the receiver set to a specific panel to configure within the wall matrix. Navigation arrows and the preview box help identify the selected unit.
  - **Step 2 – Control Options:**
    - **Reset to Basic Setup:** Restores the current panel's layout to the default configuration.
    - **Stretch Type & Rotation:** Adjusts image fitting and screen rotation.
    - **Screen Layout:** Defines the total size of the video wall (rows × columns).
    - **Row/Column Position:** Sets the current screen's position in the layout.
    - **Horizontal / Vertical Shift:** Fine-adjusts panel alignment in pixels.
    - **Horizontal / Vertical Scale Up:** Scales the image size proportionally per panel.
    - **Console API Command:** Allows manual input of control commands for advanced configuration.



PRECAUTIONS

WARRANTY  
&  
ENVIRONMENT

PACKAGE  
CONTENTS

DESCRIPTION  
&  
FEATURES

INSTALL  
&  
CONNECT

START-UP  
&  
OPERATION

PANEL  
FUNCTIONS

TECHNICAL  
DATA

### 6.3.3 Network

This interface allows users to configure the device's IP settings and select the casting mode (Multicast or Unicast).

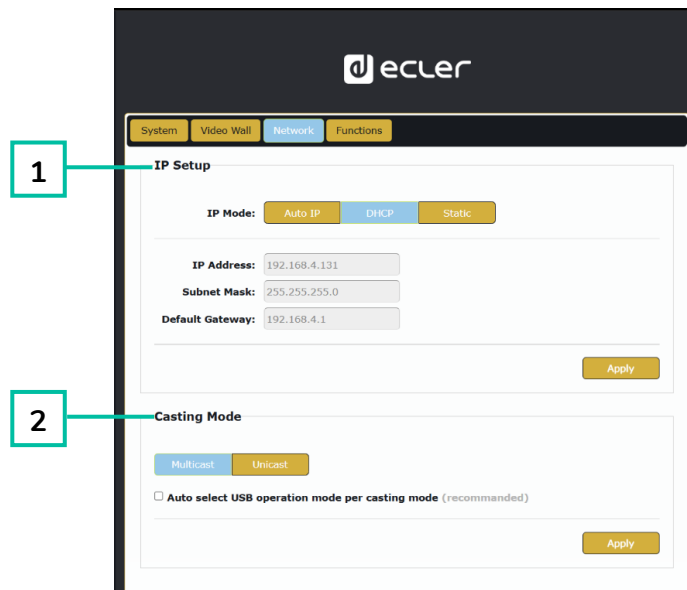

#### 1. Three IP modes are available:

- A. **Auto IP:** The IP address is assigned automatically. A new address is randomly generated each time the device is powered off and restarted.
- B. **DHCP:** The IP address is assigned dynamically by a DHCP server (e.g. a router).
- C. **Static:** A fixed IP address manually assigned by the user.

#### 2. Casting Mode: This section allows users to select how the video stream is distributed over the network.

- D. **Multicast:** The device sends the stream to multiple receivers simultaneously using a single transmission. This is efficient for large-scale distribution and minimizes bandwidth usage.
- E. **Unicast:** The device sends a separate stream to each receiver. This mode is suitable for direct one-to-one connections but consumes more bandwidth when multiple receivers are connected.
- F. **Auto Select USB Mode per Casting Mode:** When this option is enabled, it automatically adjusts the USB operation mode based on the selected casting mode.



It is recommended to keep this option enabled for optimal performance.



PRECAUTIONS

WARRANTY  
&  
ENVIRONMENT

PACKAGE  
CONTENTS

DESCRIPTION  
&  
FEATURES

INSTALL  
&  
CONNECT

START-UP  
&  
OPERATION

PANEL  
FUNCTIONS

TECHNICAL  
DATA

### 6.3.4 Functions

This section allows users to activate and configure key data transmission features over IP, including video, USB, and serial signals. These settings enable flexible and optimized device communication within a networked environment.

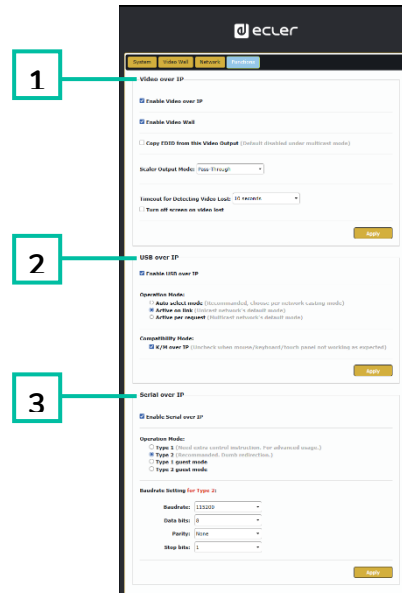

1. **Video over IP:** This section allows the user to enable or disable video transmission over the IP network and configure various video output and power-saving options.

- **Enable Video over IP:** When this checkbox is selected, video streaming over the IP network is activated.
- **Enable Video Wall:** When enabled, the system operates in video wall mode, allowing screen tiling and layout configurations. This setting should match the receiver's expected display format.
- **Copy EDID from this Video Output (optional):** If enabled, the device attempts to copy the EDID (Extended Display Identification Data) from the display connected to the video output.



**This option is disabled by default in multicast mode.**

- **Scaler Output Mode:** This dropdown menu defines how the output video resolution is handled. Available modes include:
  - **Pass-Through:** Keeps the original resolution from the source.
  - **Pass-Through (Strict):** Ensures exact match with the source, with tighter restrictions.
  - **Auto Detect (Per EDID):** Detects resolution based on connected display EDID.
  - **Full HD 1080p60 / 1080p50:** Forces output to 1920x1080 at 60 or 50 Hz.
  - **Ultra HD 2160p60 / 2160p50 / 2160p30 / 2160p25 / 2160p24:** Forces 4K output at selected frame rate.
  - **Customize:** Allows manual configuration.

- PRECAUTIONS
- WARRANTY & ENVIRONMENT
- PACKAGE CONTENTS
- DESCRIPTION & FEATURES
- INSTALL & CONNECT
- START-UP & OPERATION
- PANEL FUNCTIONS
- TECHNICAL DATA

- **Timeout for Detecting Video Lost:** Determines how long the device waits after detecting a video loss before triggering the power-saving process. Options include:
    - **3 / 5 / 10 / 20 / 30 / 60 seconds.**
    - **Never Timeout:** No action will be taken even if video is lost.
  - **Turn off screen on video lost (optional):** If selected, the display will be powered off when video signal is lost.
  - **Power Save Timeout:** Specifies the delay before entering power-saving mode after a video loss is detected. Works in conjunction with the detection timeout for calculating the total delay.
2. **USB over IP:** This section enables the transmission of USB signals over the network, allowing remote control of connected devices such as a mouse, keyboard or touch panel.
- **Enable USB over IP:** Activates the USB-over-IP functionality.
  - **Operation Mode:**
    - **Auto select mode:** Recommended. Automatically adapts to the network casting mode (Unicast or Multicast).
    - **Active on link:** USB becomes active when a network link is established (default for Unicast).
    - **Active per request:** USB becomes active only when manually requested (default for Multicast).
  - **Compatibility Mode:**
    - **K/M over IP:** Enables keyboard and mouse transmission over IP. Uncheck if input devices fail to respond properly.
3. **Serial over IP:** This section allows serial communication to be transmitted over the network, typically used for remote device control via RS-232 (in development phase).
- **Enable Serial over IP:** Activates serial-over-IP functionality.
  - **Operation Mode:**
    - **Type 1:** Requires specific control instructions. Intended for advanced users.
    - **Type 2:** Recommended mode. Simple redirection of serial data without processing.
    - **Type 1 guest mode / Type 2 guest mode:** Variants of the above for specific device configurations.
  - **Baudrate Settings for Type 2:**
    - **Baudrate:** Transmission speed (e.g., 115200 bps).
    - **Data bits:** Number of data bits per character (typically 8).
    - **Parity:** Error checking method (None, Even, Odd).
    - **Stop bits:** End of transmission bit (1 or 2).



PRECAUTIONS

WARRANTY & ENVIRONMENT

PACKAGE CONTENTS

DESCRIPTION & FEATURES

INSTALL & CONNECT

START-UP & OPERATION

PANEL FUNCTIONS

TECHNICAL DATA

## 6.4 Remote Controlling

The ID matching between a transmitter and a receiver can be performed via the device web interface or through a VEO-XCTRL4D controller with THIA-2C firmware installed and integrated into the project.

### 6.4.1 Advanced Network Management

For larger AV over IP multicast scenarios involving several THIA-2T and THIA-2R devices, it is recommended to add a VEO-XCTRL4D controller, using THIA-2C Firmware version in the system. This unit will allow the user to manage and operate all the transmitters and receivers from a unique Web interface, including Preview mode, Matrix control, Video Wall management control or even the use of TCP commands to remotely communicate with THIA-2T and THIA-2R units present in the network. For further details on how to set up an advanced networked installation control layout interface, please refer to VEO-XCTRL4D controller module user manual.

#### 6.4.1.1 Application Example

When the PoE port of the THIA-2T and THIA-2R is connected, they serve as the single interface for-JPEG2000 video and control traffic.

This configuration is ideal for simplified installations, where a unified network handles both AV and control traffic.

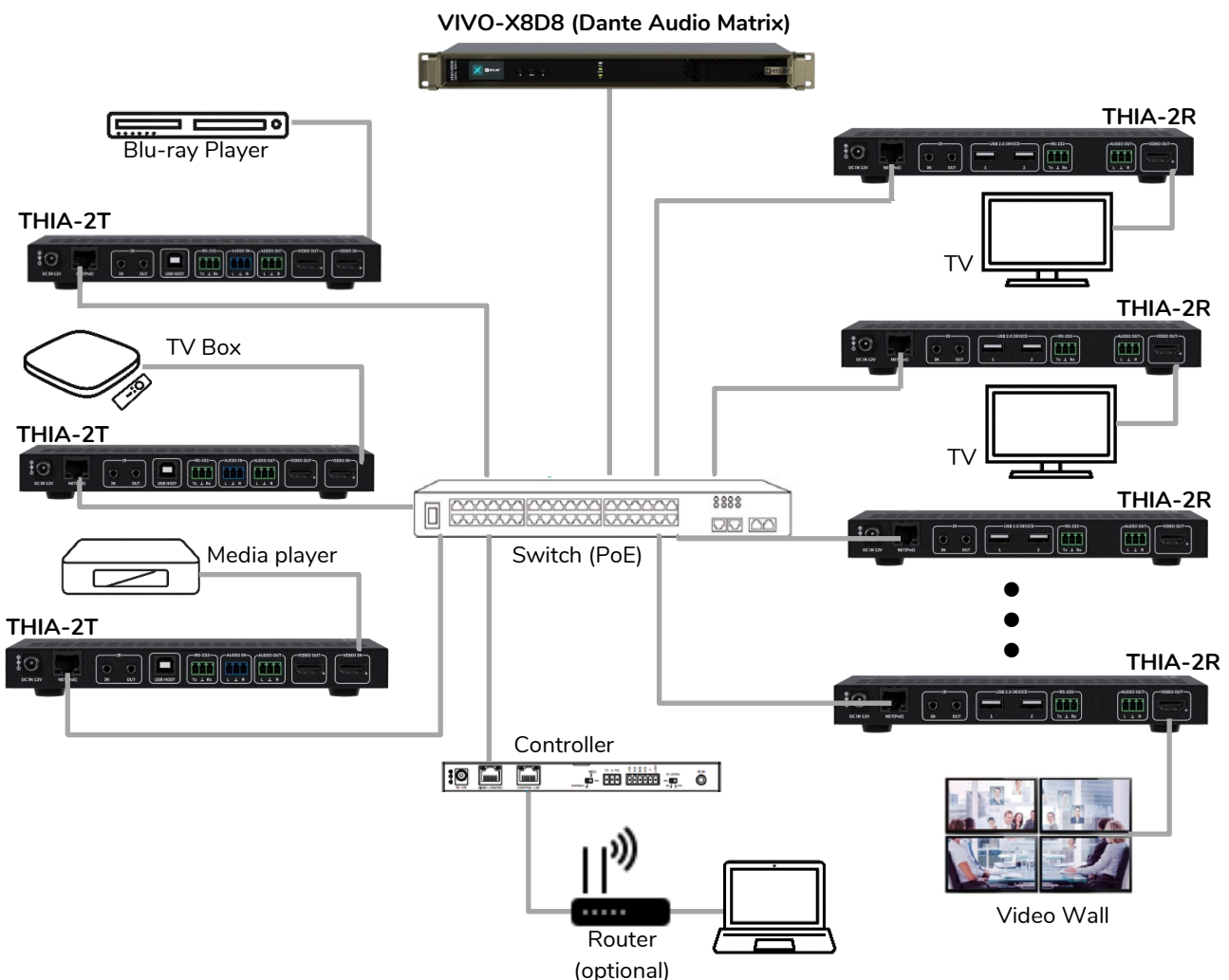

PRECAUTIONS
WARRANTY & ENVIRONMENT
PACKAGE CONTENTS
DESCRIPTION & FEATURES
INSTALL & CONNECT
START-UP & OPERATION
PANEL FUNCTIONS
TECHNICAL DATA

## 7. PANEL FUNCTIONS

### 7.1 THIA-2T

#### 7.1.1 Front Panel



1. **ON:** The POWER LED flashes when the device is power supplied and stays lid (green) after the start up is complete.
2. **LINK LED:** Network connection status LED (green):
  - **Light on:** Network connection is stable and there's a compatible video signal.
  - **Light off:** No network connection.
  - **Light flashing:** Network connection is stable but there's no video signal.
3. **RESET** System reset button. After powering on the device, press and hold the RESET button until both the ON LED and LINK LED flash simultaneously. Next release the button to restore the device to factory settings.



PRECAUTIONS

WARRANTY  
&  
ENVIRONMENT

PACKAGE  
CONTENTS

DESCRIPTION  
&  
FEATURES

INSTALL  
&  
CONNECT

START-UP  
&  
OPERATION

PANEL  
FUNCTIONS

TECHNICAL  
DATA

## 7.1.2 Rear Panel

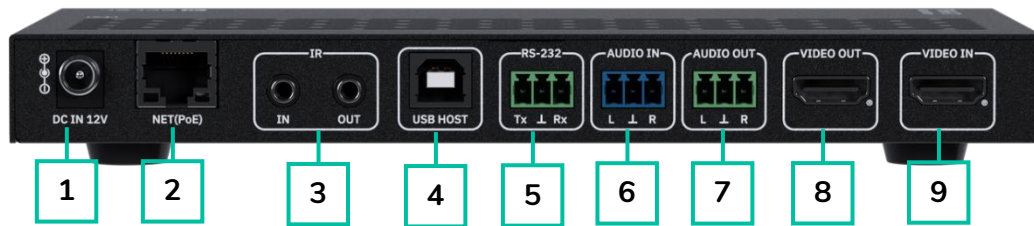

1. **DC 12V Port:** Allows power supply via 12V/1A DC adapter. The device can also be powered via PoE if available from the network switch; in this case, the DC adapter is not required.
2. **NET (PoE):** 1G LAN port with PoE support.
3. **IR:**
  - **IN:** Infrared signal input interface (12V).
  - **OUT:** Infrared signal output interface (12V).
4. **USB HOST:** USB-B connector for connecting a PC as KVM function.
5. **RS-232:** Bidirectional serial signal interface.
6. **AUDIO IN:** Analogue audio input for embedding into the HDMI signal or looping out via the AUDIO OUT port.
7. **AUDIO OUT:** Outputs audio extracted from HDMI IN (LPCM) or analogue audio from the decoder's AUDIO IN in unicast mode.
8. **VIDEO OUT:** HDMI loop out for display.
9. **VIDEO IN:** HDMI signal input interface.



PRECAUTIONS

WARRANTY  
&  
ENVIRONMENT

PACKAGE  
CONTENTS

DESCRIPTION  
&  
FEATURES

INSTALL  
&  
CONNECT

START-UP  
&  
OPERATION

PANEL  
FUNCTIONS

TECHNICAL  
DATA

## 7.2 THIA-2R

### 7.2.1 Front Panel



1. **ON:** The POWER LED flashes when the device is power supplied and stays lid (green) after the start up is complete.
2. **LINK LED:** Network connection status LED (green):
  - **Light on:** Network connection is stable and there's a compatible video signal.
  - **Light off:** No network connection.
  - **Light flashing:** Network connection is stable but there's no video signal.
3. **RESET** System reset button. After powering on the device, press and hold the RESET button until both the ON LED and LINK LED flash simultaneously. Next release the button to restore the device to factory settings.



PRECAUTIONS

WARRANTY  
&  
ENVIRONMENT

PACKAGE  
CONTENTS

DESCRIPTION  
&  
FEATURES

INSTALL  
&  
CONNECT

START-UP  
&  
OPERATION

PANEL  
FUNCTIONS

TECHNICAL  
DATA

## 7.2.1 Rear Panel

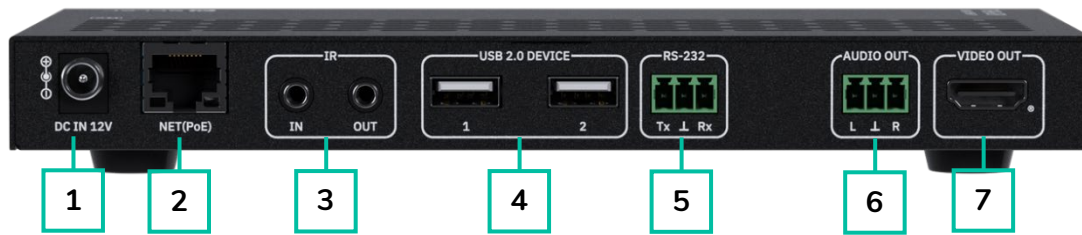

1. **DC 12V Port:** Allows power supply via 12V/1A adapter or PoE. If PoE is available from the network switch, no external adapter is needed.
2. **NET (PoE):** 1G Ethernet LAN port with PoE support.
3. **IR:**
  - **IN:** Infrared signal input interface (12V).
  - **OUT:** Infrared signal output interface (12V).
4. **USB 2.0 DEVICE:** Two connection ports for USB 2.0 devices, such as USB flash disk or USB Camera.
5. **RS-232:** Bidirectional serial signal interface.
6. **AUDIO OUT:** Outputs audio extracted from HDMI IN (LPCM) or analogue audio from the decoder's AUDIO IN in unicast mode.
7. **VIDEO OUT:** HDMI loop output for connecting to a local display device.



PRECAUTIONS

WARRANTY  
&  
ENVIRONMENT

PACKAGE  
CONTENTS

DESCRIPTION  
&  
FEATURES

INSTALL  
&  
CONNECT

START-UP  
&  
OPERATION

PANEL  
FUNCTIONS

TECHNICAL  
DATA

### 7.3 IR Pin Definition

For both models, THIA-2T and THIA-2R, the IR ports use standard 3.5mm stereo jacks and are compatible with both IR Blasters and IR Receivers. Each device type has a different pin configuration, which must be considered when connecting external IR accessories.

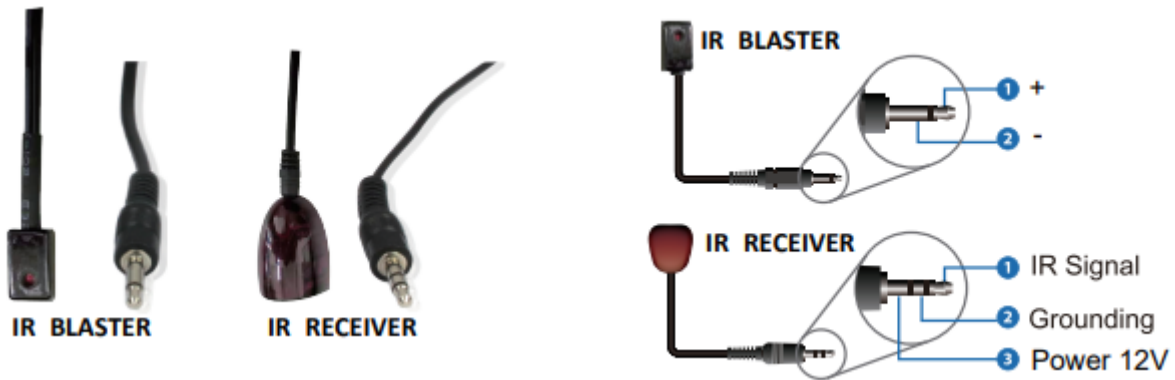

- **IR Blaster:** Used to transmit IR signals to control external devices (e.g., displays, media players).
  - Pin 1: + (Power)
  - Pin 2: – (Ground)
- **IR Receiver:** Used to receive IR signals from remote controls.
  - Pin 1: IR Signal
  - Pin 2: Ground
  - Pin 3: Power (12V)

**⚠** Incorrect wiring may cause malfunction or damage to the IR components. Always verify pinout compatibility when using third-party IR hardware.

PRECAUTIONS
WARRANTY & ENVIRONMENT
PACKAGE CONTENTS
DESCRIPTION & FEATURES
INSTALL & CONNECT
START-UP & OPERATION
PANEL FUNCTIONS
TECHNICAL DATA

## 8. TECHNICAL DATA

### 8.1 Technical Specifications

#### 8.1.1 THIA-2T

##### THIA-2T

Video performances	
Video Input Connectors	1 x HDMI® Type A Female, 2.0b, 18 Gbps
Video Output Connectors	1 x HDMI® Type A Female, 2.0b, 18 Gbps
Video Input Resolutions	480i, 480p, 720i, 720p, 1080i, 1080p, 4K up to 60Hz
Video Output Resolutions	4K up to 30Hz (4:4:4)
Video Codec	Main Stream: JPEG2000 Secondary Stream: H.265
Transmission Latency	1-2 Frames
Chroma Subsampling	4:4:4, 4:2:2, 4:2:0
Colour Depth	8-bit (4K 30Hz 4:4:4) , 10-bit / 12-bit (4K 30Hz 4:2:2 – 4:2:0)
Colour Space	RGB, YCbCr (4:4:4 / 4:2:2), YUV (4:2:0)
HDCP	2.2
HDR	HDR10, HDR10+
Video Composing Capabilities	Videowall up to 9x9
Scaling Features	No
HDMI® Distance	Up to 4K/60Hz: up to 5m with IN/OUT HDMI® Cable Up to 4K/30Hz: up to 10m with IN/OUT HDMI® Cable Up to 1080P/60Hz: up to 15m with IN/OUT HDMI® Cable
Audio performances	
Audio Input Connectors	1 x 3-pin unbalanced Euroblock
Audio Output Connectors	1 x 3-pin unbalanced Euroblock
Audio Formats	LPCM 2.0/5.1/7.1CH, Dolby Digital/Plus/EX, Dolby True HD, Dolby Atmos, DTS, DTS-96/24, DTS-EX DSD, DTS High Res, DTS-HD Master, DTS:X
Sample Rate	48KHz, 96KHz, 192KHZ
Bit Depth	Up to 24-bit
Frequency Response	20Hz-20KHz (±3dB)
ARC/eARC	No
Device control	
Control Connectors	1 x RJ45, 1 x 3-pin Euroblock, 2 x Jack 3,5mm
Control Protocols	Web, Telnet, RS-232 (in development), IR
Control Buttons	No
EDID Management	EDID Settings
Status Indicators	Power LED, Link LED
Pass-through control	
Pass-through Connectors	1 x USB Type B, 1 x 3-pin Euroblock, 2 x 3.5mm Jack, 2 x HDMI®
Pass-through Protocols	USB 2.0, RS-232, IR, CEC
Network	
Network Connectors	1 x RJ-45
Network Requirements	Jumbo Frame, IGMP Management
Average Streaming Bitrate	218Mbps for 4K/30Hz
Transmission Distance	100m via Ethernet (Cat 6 / 6A / 7)



PRECAUTIONS

WARRANTY & ENVIRONMENT

PACKAGE CONTENTS

DESCRIPTION & FEATURES

INSTALL & CONNECT

START-UP & OPERATION

PANEL FUNCTIONS

TECHNICAL DATA

Electrical

Power supply	PoE; External: Input 100-240 VAC-50/60Hz, Output: 12VDC-1A
AC mains connector	External PSU. Included 4 region power blades (UK,US,AU,EU)
DC mains connector	DC Locking
Power consumption	8W

Physical

Operating temperature	Min: 0°C / 32°F Max: 40°C / 104°F
Operating humidity	20% - 90% RH, no condensing
Storage temperature	Min: -20°C / -4°F Max: 60°C / 140°F
Storage humidity	20% - 90% RH, no condensing
Installation options	Desktop, THIA-RK
Included accessories	1 x IR Receiver cable (1.5 meters), 1 x IR Blaster cable (1.5 meters), 2 x 3-pin 3.5mm Euroblock connector (Green), 1 x 3-pin 3.5mm Euroblock connector (Blue), 2 x Mounting ears, 4 x Mounting screw, 1 x PSU 12V/1A
Optional accessories	VEO-XCTRL4D, THIA-RK
Dimensions (WxHxD)	204 x 21.5 x 100 mm / 8.03x 0.85x 3.94 in.
Weight	0.509 Kg / 1.122 lb
Shipping dimensions (WxHxD)	255 x 75.5 x 160 mm / 10.04 x 2.97 x 6.30 in.
Shipping weight	0.96Kg / 2.12 lb
Chassis material	Metal
Finished colour	Black



PRECAUTIONS

WARRANTY & ENVIRONMENT

PACKAGE CONTENTS

DESCRIPTION & FEATURES

INSTALL & CONNECT

START-UP & OPERATION

PANEL FUNCTIONS

TECHNICAL DATA

## 8.1.2 THIA-2R

### THIA-2R

Video performances	
Video Input Connectors	No
Video Output Connectors	1 x HDMI® Type A Female, 2.0b, 18 Gbps
Video Input Resolutions	480i, 480p, 720i, 720p, 1080i, 1080p, 4K up to 60Hz
Video Output Resolutions	4K up to 30Hz (4:4:4)
Video Codec	Main Stream: JPEG2000 Secondary Stream: H.265
Transmission Latency	1-2 Frames
Chroma Subsampling	4:4:4, 4:2:2, 4:2:0
Colour Depth	8-bit (4K/30Hz 4:4:4) , 10-bit / 12-bit (4K/30Hz 4:2:2 – 4:2:0)
Colour Space	RGB, YCbCr (4:4:4 / 4:2:2), YUV (4:2:0)
HDCP	2.2
HDR	HDR10, HDR10+
Video Composing Capabilities	Videowall up to 9x9
Scaling Features	Yes
HDMI® Distance	Up to 4K/60Hz up to 5m with IN/OUT HDMI® Cable Up to 4K/30Hz up to 10m with IN/OUT HDMI® Cable Up to 1080P/60Hz up to 15m with IN/OUT HDMI® Cable
Audio performances	
Audio Input Connectors	No
Audio Output Connectors	1 x 3-pin unbalanced Euroblock
Audio Formats	LPCM 2.0/5.1/7.1CH, Dolby Digital/Plus/EX, Dolby True HD, Dolby Atmos, DTS, DTS-96/24, DTS-EX DSD, DTS High Res, DTS-HD Master, DTS:X
Sample Rate	48KHz, 96KHz, 192KHz
Bit Depth	Up to 24-bit
Frequency Response	20Hz-20KHz (±3dB)
ARC/eARC	No
Device control	
Control Connectors	1 x RJ45, 1 x 3-pin Euroblock, 2 x Jack 3,5mm
Control Protocols	Web, Telnet, RS-232 (in development), IR
Control Buttons	No
EDID Management	EDID Settings
Status Indicators	Power LED, Link LED
Pass-through control	
Pass-through Connectors	2 x USB Type A, 1 x 3-pin Euroblock, 2 x 3.5mm Jack, 1 x HDMI®
Pass-through Protocols	USB 2.0, RS-232, IR, CEC
Network	
Network Connectors	1 x RJ-45
Network Requirements	Jumbo frame, IGMP Management
Average Streaming Bitrate	218Mbps for 4K/30Hz
Transmission Distance	100m via Ethernet (Cat 6 / 6A / 7)
Electrical	
Power supply	PoE; External: Input 100-240 VAC-50/60Hz, Output: 12VDC-1A
AC mains connector	External PSU. Included 4 region power blades (UK,US,AU,EU)
DC mains connector	DC Locking
Power consumption	4W

PRECAUTIONS
WARRANTY & ENVIRONMENT
PACKAGE CONTENTS
DESCRIPTION & FEATURES
INSTALL & CONNECT
START-UP & OPERATION
PANEL FUNCTIONS
TECHNICAL DATA

## Physical

Operating temperature	Min: 0°C / 32°F Max: 40°C / 104°F
Operating humidity	20% - 90% RH, no condensing
Storage temperature	Min: -20°C / -4°F Max: 60°C / 140°F
Storage humidity	20% - 90% RH, no condensing
Installation options	Desktop, THIA-RK
Included accessories	1 x IR Receiver cable (1.5 meters), 1 x IR Blaster cable (1.5 meters), 2 x 3-pin 3.5mm Euroblock connector (Green), 2 x Mounting ears, 4 x Mounting screw, 1 x PSU 12V/1A
Optional accessories	VEO-XCTRL4D, THIA-RK
Dimensions (WxHxD)	204 x 21.5 x 100 mm / 8.03x 0.85x 3.94 in.
Weight	0.496 Kg / 1.093 lb.
Shipping dimensions (WxHxD)	255 x 75.5 x 160 mm / 10.04 x 2.97 x 6.30 in.
Shipping weight	0.96Kg / 2.12 lb.
Chassis material	Metal
Finished colour	Black



PRECAUTIONS

WARRANTY & ENVIRONMENT

PACKAGE CONTENTS

DESCRIPTION & FEATURES

INSTALL & CONNECT

START-UP & OPERATION

PANEL FUNCTIONS

TECHNICAL DATA



## 8.2.2 THIA-2R

All measurements are in mm.

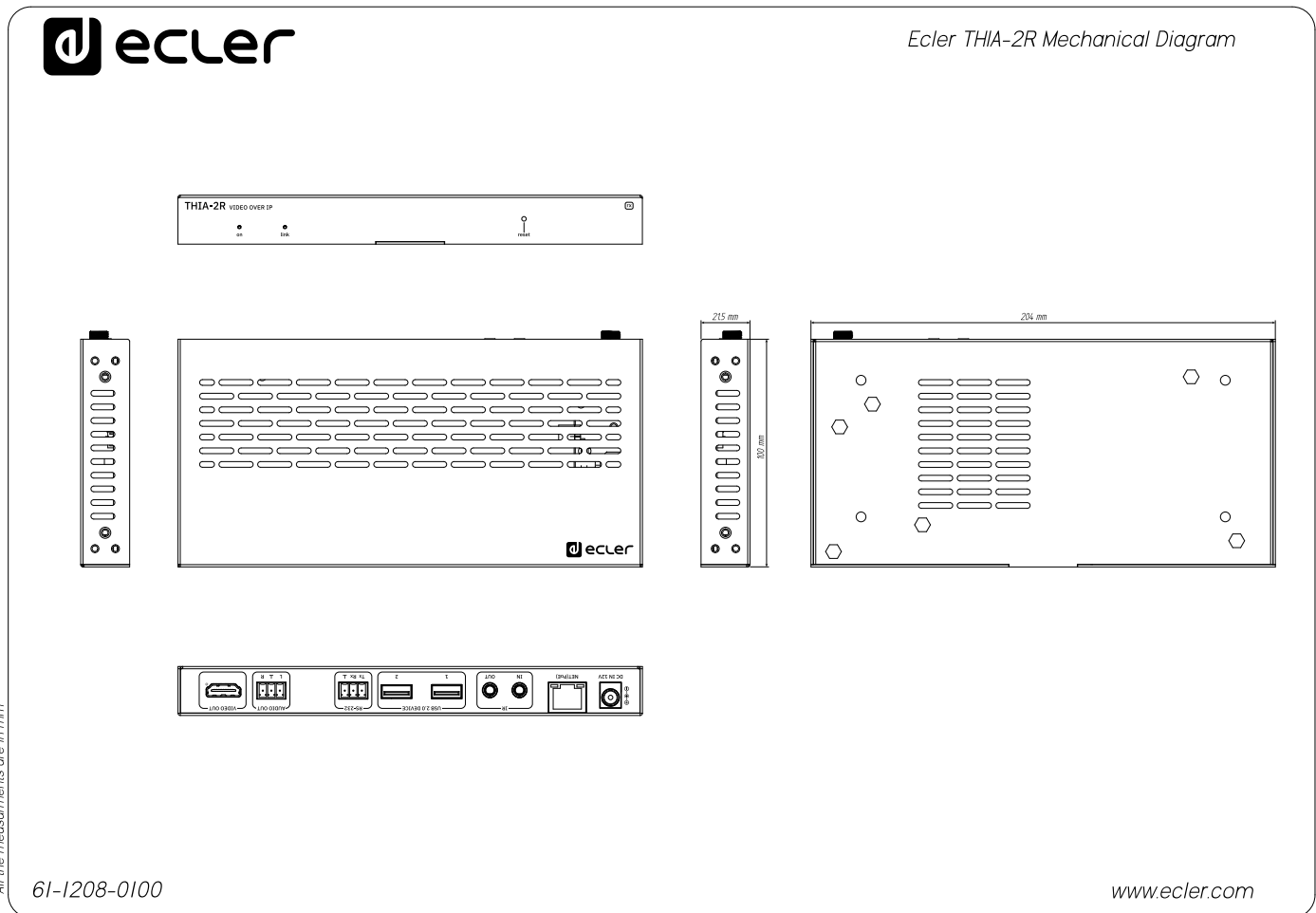

All the measurements are in mm

PRECAUTIONS
WARRANTY & ENVIRONMENT
PACKAGE CONTENTS
DESCRIPTION & FEATURES
INSTALL & CONNECT
START-UP & OPERATION
PANEL FUNCTIONS
TECHNICAL DATA



PRECAUTIONS

WARRANTY  
&  
ENVIRONMENT

PACKAGE  
CONTENTS

DESCRIPTION  
&  
FEATURES

INSTALL  
&  
CONNECT

START-UP  
&  
OPERATION

PANEL  
FUNCTIONS

TECHNICAL  
DATA